

VIZIO

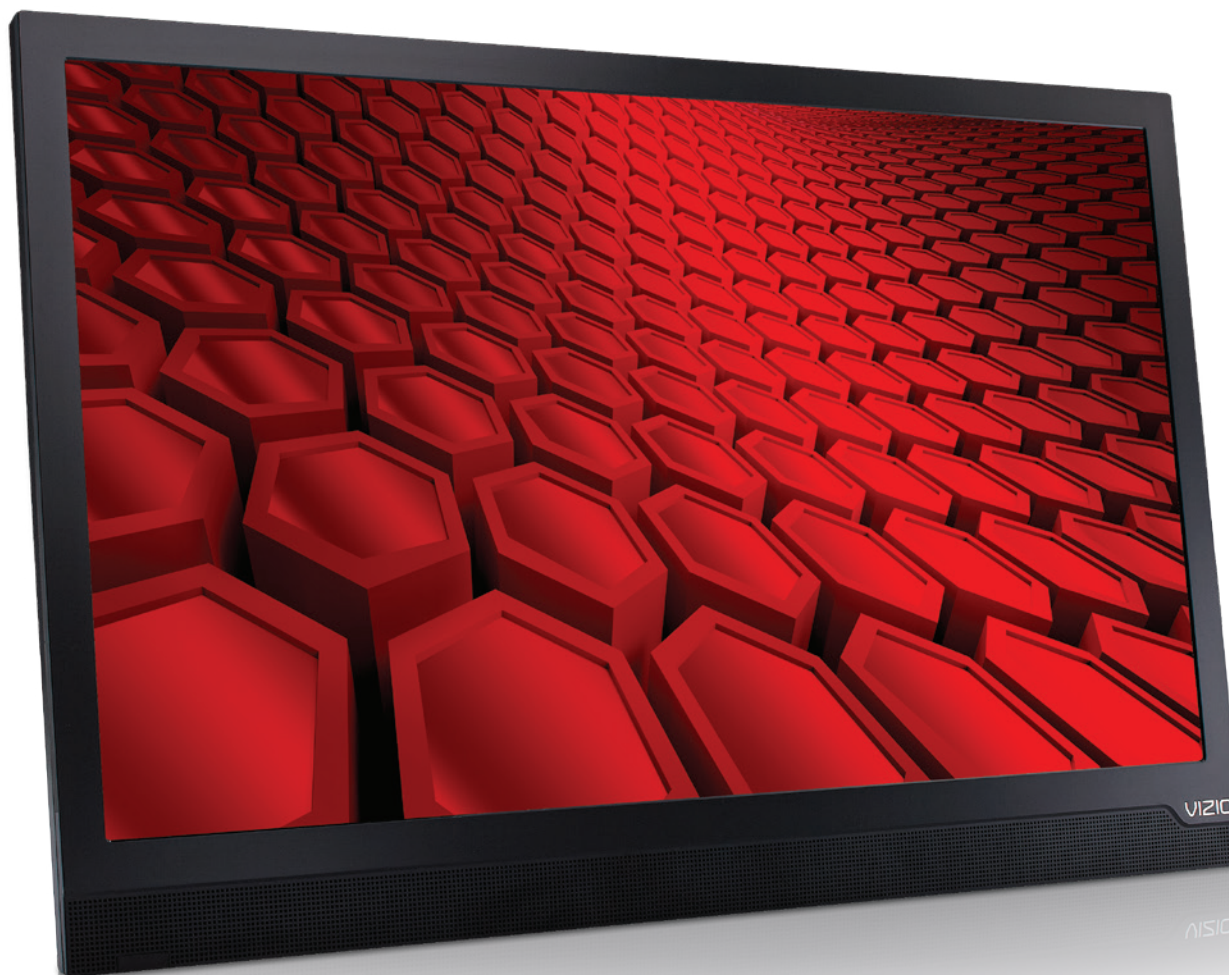

USER MANUAL
Model: E241-A1 & E291-A1



This product qualifies for ENERGY STAR in the "factory default" setting and this is the setting in which power savings will be achieved. Changing the factory default picture settings or enabling other features will increase power consumption that could exceed the limits necessary to qualify for ENERGY STAR rating.



SRS StudioSound HD and SRS TruVolume are trademarks of SRS Labs, Inc. StudioSound HD and TruVolume technologies are incorporated under license from SRS Labs, Inc.

Manufactured under license from Dolby Laboratories. Dolby and the double-D symbol are trademarks of Dolby Laboratories.

HDMI, the HDMI logo and High-Definition Multimedia Interface are trademarks or registered trademarks of HDMI Licensing LLC.

Welcome

THANK YOU FOR CHOOSING VIZIO

And congratulations on your new VIZIO HDTV.

To get the most out of your new VIZIO product, read these instructions before using your product and retain them for future reference. Be sure to inspect the package contents to ensure there are no missing or damaged parts.

PRODUCT REGISTRATION

To purchase or inquire about accessories and installation services for your VIZIO product, visit our website at www.VIZIO.com or call toll free at (877) 878-4946.

We recommend that you either:

- Register your VIZIO product at www.VIZIO.com
- Complete and mail the enclosed registration card

Extended Warranties

For peace of mind, and to protect your investment beyond the standard warranty, VIZIO offers on-site extended warranty service plans. These plans provide additional coverage during the standard warranty period. To purchase an extended warranty service plan, visit www.VIZIO.com.

WHEN READING THIS MANUAL



When you see this symbol, please read the accompanying important warning or notice. It is intended to alert you to the presence of important operating instructions.



When you see this symbol, please read the accompanying helpful tip.

IMPORTANT SAFETY INSTRUCTIONS

Your TV is designed and manufactured to operate within defined design limits. Misuse may result in electric shock or fire. To prevent your TV from being damaged, the following instructions should be observed for the installation, use, and maintenance of your TV. Read the following safety instructions before operating your TV. Keep these instructions in a safe place for future reference.

- To reduce the risk of electric shock or component damage, switch off the power before connecting other components to your TV.
- Read these instructions.
- Keep these instructions.
- Heed all warnings.
- Follow all instructions.
- Do not use this apparatus near water.
- Clean only with dry cloth.
- Do not block any ventilation openings. Install in accordance with the manufacturer's instructions.
- Do not install near any heat sources such as radiators, heat registers, stoves, or other apparatus (including amplifiers) that produce heat.
- Do not defeat the safety purpose of the polarized or grounding-type plug. A polarized plug has two blades with one wider than the other. A grounding type plug has two blades and a third grounding prong. The wide blade or the third prong are provided for your safety. If the provided plug does not fit into your outlet, consult an electrician for replacement of the obsolete outlet.
- Protect the power cord from being walked on or pinched, particularly at plugs, convenience receptacles, and the point where they exit from the apparatus.
- Only use attachments/accessories specified by the manufacturer.



- Use only with the cart, stand, tripod, bracket, or table specified by the manufacturer, or sold with the apparatus. When a cart is used, use caution when moving the cart/apparatus combination to avoid injury from tip-over.
- Unplug this apparatus during lightning storms or when unused for long periods of time.
- Refer all servicing to qualified service personnel. Servicing is required when the apparatus has been damaged in any way, such as when the power-supply cord or plug is damaged, liquid has been spilled or objects have fallen into the apparatus, the apparatus has been exposed to rain or moisture, does not operate normally or has been dropped.
- Unplug the power cord before cleaning your TV.
- When moving your TV from an area of low temperature to an area of high temperature, condensation may form in the housing. Wait before turning on your TV to avoid causing fire, electric shock, or component damage.
- A distance of at least three feet should be maintained between your TV and any heat source, such as a radiator, heater, oven, amplifier etc. Do not install your TV close to smoke. Operating your TV close to smoke or moisture may cause fire or electric shock.
- Slots and openings in the back and bottom of the cabinet are provided for ventilation. To ensure reliable operation of your TV and to protect it from overheating, be sure these openings are not blocked or covered. Do not place your TV in a bookcase or cabinet unless proper ventilation is provided.
- Never push any object into the slots and openings on your TV cabinet. Do not place any objects on the top of your TV. Doing so could short circuit parts causing a fire or electric shock. Never spill liquids on your TV.
- Your TV should be operated only from the type of power

source indicated on the label. If you are not sure of the type of power supplied to your home, consult your dealer or local power company.

- Do not apply pressure or throw objects at your TV. This may compromise the integrity of the display. The manufacturer's warranty does not cover user abuse or improper installations.
- The power cord must be replaced when using different voltage than the voltage specified. For more information, contact your dealer.
- Your TV is equipped with a three-pronged grounded plug (a plug with a third grounding pin). This plug will fit only into a grounded power outlet. This is a safety feature. If your outlet does not accommodate the three-pronged, have an electrician install the correct outlet, or use an adapter to ground your TV safely. Do not defeat the safety purpose of the grounded plug.
- When connected to a power outlet, power is always flowing into your TV. To totally disconnect power, unplug the power cord.
- The lightning flash with arrowhead symbol within an equilateral triangle is intended to alert the user to the presence of un-isolated, dangerous voltage within the inside of your TV that may be of sufficient magnitude to constitute a risk of electric shock to persons.
- Do not overload power strips and extension cords. Overloading can result in fire or electric shock.
- The wall socket should be installed near your TV and easily accessible.
- Only power of the marked voltage can be used for your TV. Any other voltage than the specified voltage may cause fire or electric shock.
- Do not touch the power cord during lightning. To avoid electric shock, avoid handling the power cord during electrical storms.
- Unplug your TV during a lightning storm or when it will not

be used for long period of time. This will protect your TV from damage due to power surges.

- Do not attempt to repair or service your TV yourself. Opening or removing the back cover may expose you to high voltages, electric shock, and other hazards. If repair is required, contact your dealer and refer all servicing to qualified service personnel.
- **WARNING:** Keep your TV away from moisture. Do not expose your TV to rain or moisture. If water penetrates into your TV, unplug the power cord and contact your dealer. Continuous use in this case may result in fire or electric shock.
- Do not use your TV if any abnormality occurs. If any smoke or odor becomes apparent, unplug the power cord and contact your dealer immediately. Do not try to repair your TV yourself.
- Avoid using dropped or damaged appliances. If your TV is dropped and the housing is damaged, the internal components may function abnormally. Unplug the power cord immediately and contact your dealer for repair. Continued use of your TV may cause fire or electric shock.
- Do not install your TV in an area with heavy dust or high humidity. Operating your TV in environments with heavy dust or high humidity may cause fire or electric shock.
- Follow instructions for moving your TV. Ensure that the power cord and any other cables are unplugged before moving your TV.
- When unplugging your TV, hold the AC/DC power adapter, not the cord. Pulling on the power cord may damage the wires inside the cord and cause fire or electric shock. When your TV will not be used for an extended period of time, unplug the power cord.
- To reduce risk of electric shock, do not touch the connector with wet hands.
- Insert batteries in accordance with instructions. Incorrect

polarities may cause the batteries to leak which can damage the remote control or injure the operator. Do not expose batteries to excessive heat such as sunshine, fire or the like.

- If any of the following occurs, contact the dealer:
 - The power cord fails or frays.
 - Liquid sprays or any object drops into your TV.
 - Your TV is exposed to rain or other moisture.
 - Your TV is dropped or damaged in any way.
 - The performance of your TV changes substantially.
- This apparatus shall not be exposed to dripping or splashing and no objects fill with liquids, such as vases, shall be placed on the apparatus.
- The mains plug or appliance coupler is used as the disconnect device, the disconnect device shall remain readily operable.
- **CAUTION** - These servicing instructions are for use by qualified service personnel only. To reduce the risk of electric shock, do not perform any servicing other than that contained in the operating instructions unless you are qualified to do so.



The lightning flash with arrowhead symbol within an equilateral triangle is intended to alert the user to the presence of uninsulated **DANGEROUS VOLTAGE** within the product's enclosure that may be of sufficient magnitude to constitute a risk of electrical shock to persons.

TELEVISION ANTENNA CONNECTION PROTECTION

If an outside antenna/satellite dish or cable system is to be connected to the TV, make sure that the antenna or cable system is electrically grounded to provide some protection against voltage surges and static charges.

Article 810 of the National Electrical Code, ANSI/NFPA 70, provides information with regard to proper grounding of the mast and supporting structure, grounding of the lead-in wire to an antenna discharge unit, size of the grounding conductors, location of antenna discharge unit, connection to grounding electrodes, and requirements of the grounding electrode.

Lightning Protection

For added protection of the TV during a lightning storm or when it is left unattended or unused for long periods of time, unplug the TV from the wall outlet and disconnect the antenna or cable system.

Power Lines

Do not locate the antenna near overhead light or power circuits, or where it could fall into such power lines or circuits. Remember, the screen of the coaxial cable is intended to be connected to earth in the building installation.

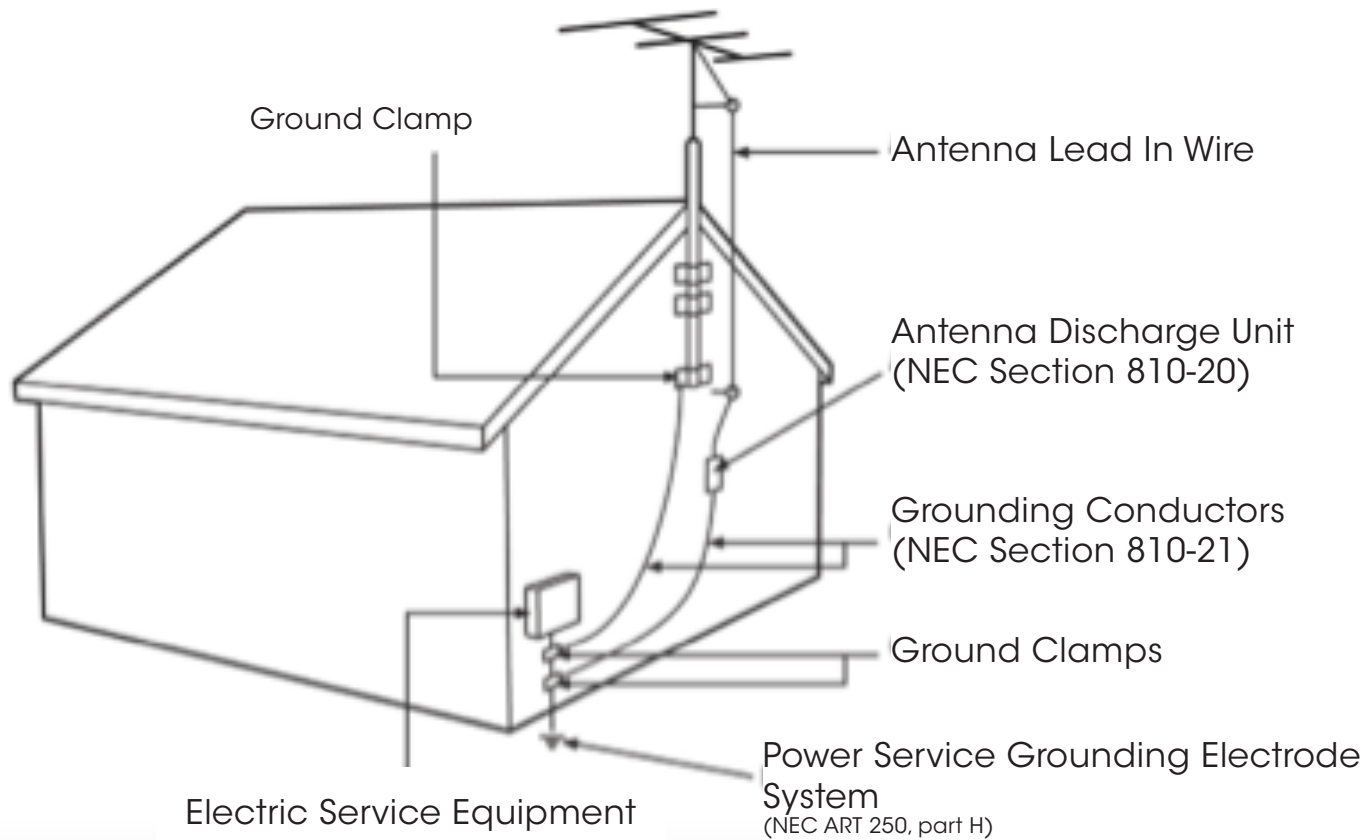

Table of Contents

Installing the TV	3	Adjusting the Advanced Picture Settings.....	22
Inspecting the Package Contents	3	Adjusting the Color Temperature	23
Installing the TV.....	3	Adjusting the Picture Size and Position	23
Installing the TV Stand	3	Resetting the Picture Settings	24
Installing the TV on a Wall.....	5	Adjusting the Audio Settings.....	24
Controls and Connections	6	Adjusting the Advanced Audio Settings	25
Front Panel.....	8	Resetting the Audio Settings.....	26
Remote Control	9	Changing the Advanced Network Settings	26
Replacing the Batteries	10	Testing Your Network Connection.....	27
Connecting Your Devices.....	11	Changing the TV Settings.....	27
Connecting A Device	11	Changing the Input Source.....	28
Connecting a Device - Audio and Video Cable Types.....	12	Setting the Tuner Mode.....	28
Connecting an Audio Device	13	Scanning for Channels.....	29
Connecting an Audio Device - Audio Cable Types	14	Adding New Channels	29
Connecting an Audio Device - ARC.....	15	Skipping Channels.....	30
Without HDMI ARC.....	15	Changing the Audio Language	31
With HDMI ARC	15	Using the Parental Controls	32
Completing the First-Time Setup.....	16	Accessing the Parental Controls Menu	32
Using the On-Screen Menu	17	Enabling or Disabling Program Ratings.....	32
Navigating the On-Screen Menu	17	Locking and Unlocking Channels	32
Changing the Input Source	18	Blocking and Unblocking Content by Rating.....	33
Changing the Screen Aspect Ratio	18	Changing the Parental Control Passcode	33
Setting Up Closed Captioning	19	Resetting the Content Locks.....	33
Changing the Appearance of Digital Closed Captions.....	19	Changing the Names of the Inputs	34
Activating the Sleep Timer.....	20	Changing the On-Screen Menu Language	34
Setting the Auto Power Off Feature.....	20	Setting the Time Zone	35
Adjusting the Picture Settings	21	Adjusting the CEC Settings.....	35
		Turning the Power Indicator Light On or Off	36
		Using the Help Menu	36

Displaying System Information	37
Resetting the TV Settings.....	37
Restoring the TV to Factory Default Settings	38
Using Guided Setup.....	38
Using the Info Window	39
Using the USB Media Player	40
Using the USB Media Player.....	40
Connecting a USB Thumb Drive to the TV.....	40
Playing USB Media	40
Troubleshooting & Technical Support.....	42
Specifications	45
Limited Warranty.....	47
Legal & Compliance.....	48

INSPECTING THE PACKAGE CONTENTS

Before installing your new TV, take a moment to inspect the package contents. Use the images below to ensure nothing is missing or damaged.



VIZIO LED HDTV with Stand



Quick Start Guide



Power Cord



Remote Control with Batteries

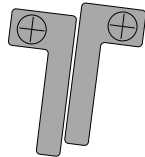

2 x Rubber Feet



2 x Phillips Screws

PACKAGE CONTENTS

INSTALLING THE TV

After removing the TV from the box and inspecting the package contents you can begin installing the TV. Your TV can be installed in two ways:

- On a flat surface, using the included stand
- On a wall, using a VESA-standard wall mount (not included)

Installing the TV Stand

Your TV includes a stand designed to support the weight of the TV and keep it from falling over. However, the TV can still fall over if:

- It is placed on an uneven, unstable, or non-level surface
- It is pushed, pulled, or otherwise improperly moved
- If an earthquake occurs and the TV is not properly secured

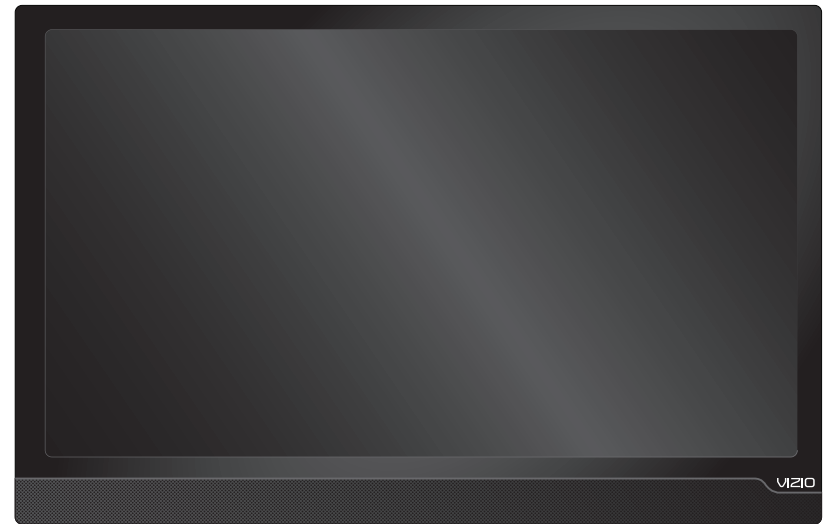

TV ON STAND

To install the base:

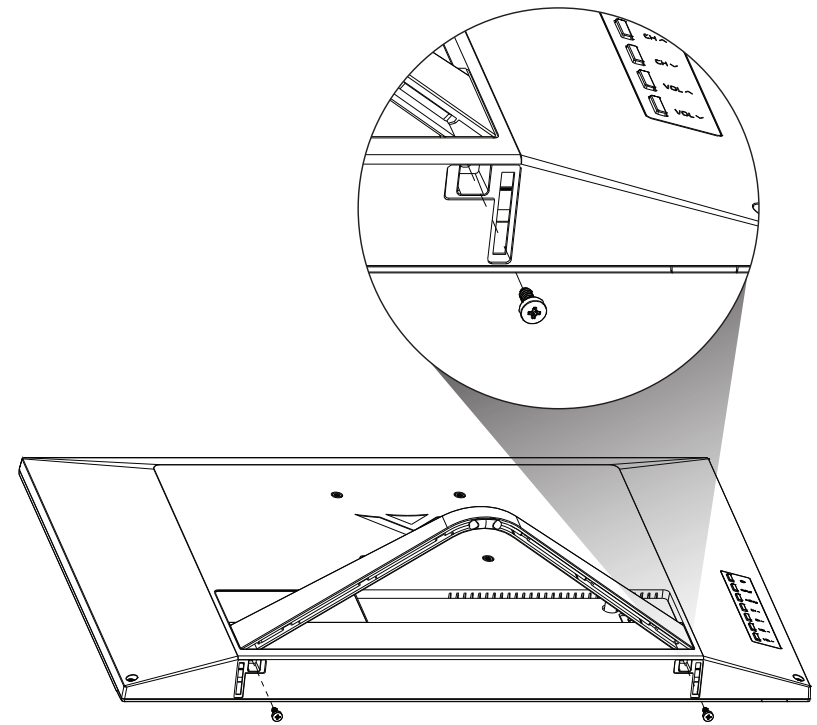
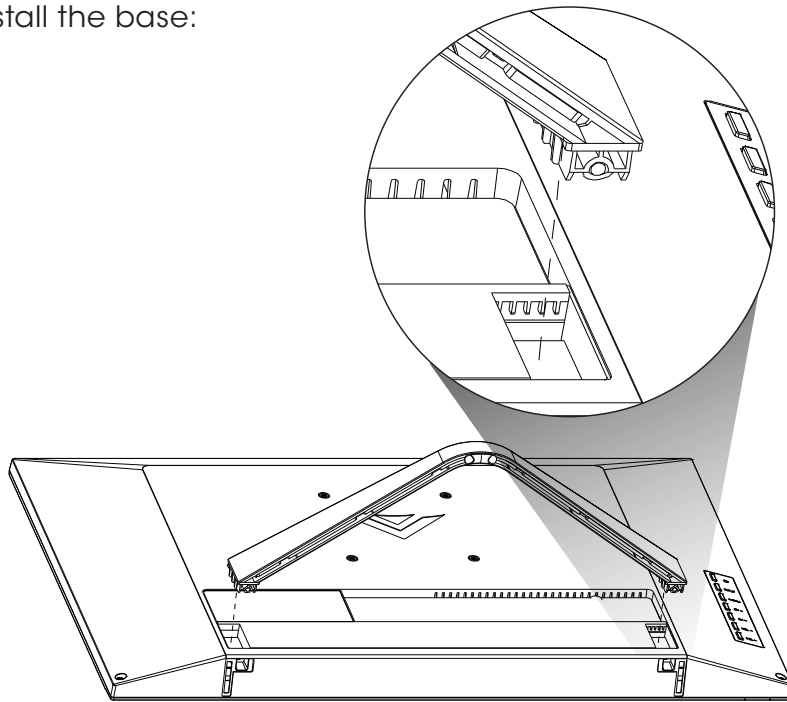

1. Place the TV screen-down on a clean, flat surface. To prevent scratches or damage to the screen, place the TV on a soft surface, such as a blanket.

2. Insert and tighten the two(2) included Phillips screws into the base with a Phillips screwdriver. (Not included)

Gently push the base into the slots as shown.

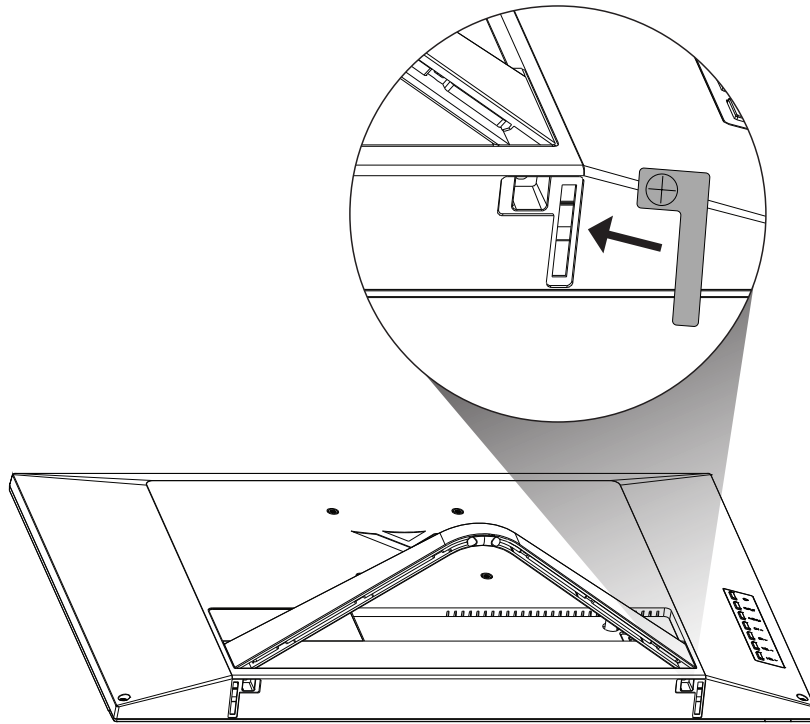

3. Insert the two(2) included rubber feet over the screws as shown and press firmly to secure them.

When you are finished, place the TV on a stable, level surface.

Installing the TV on a Wall

To mount your TV on a wall, you will need a wall mount. Consult the information below to find the appropriate mount for your TV model:



Installing a TV on a wall requires lifting. To prevent injury or damage to the TV, ask someone to help you.

	E241-A1	E291-A1
Screw Size:	M4	M4
Screw Pitch:	0.70mm	0.70mm
Screw Length:	10mm	10mm
Hole Pattern:	100mm (V) x 100mm (H)	100mm (V) x 100mm (H)

Be sure the mount you choose is capable of supporting the weight of the TV. After you have determined that you have the correct mount for your TV, you can begin the installation.

To install your TV on a wall:

1. Disconnect any cables connected to your TV.
2. Place the TV face-down on a clean, flat, stable surface. Be sure the surface is clear of debris that can scratch or damage the TV.
3. Remove the base by loosening and removing the screws.
4. Attach your TV and wall mount to the wall, carefully following the instructions that came with your mount.

Use only with a UL-listed wall mount bracket rated for the weight/load of this TV. See *Appendix A - Specifications* for the weight of this TV.

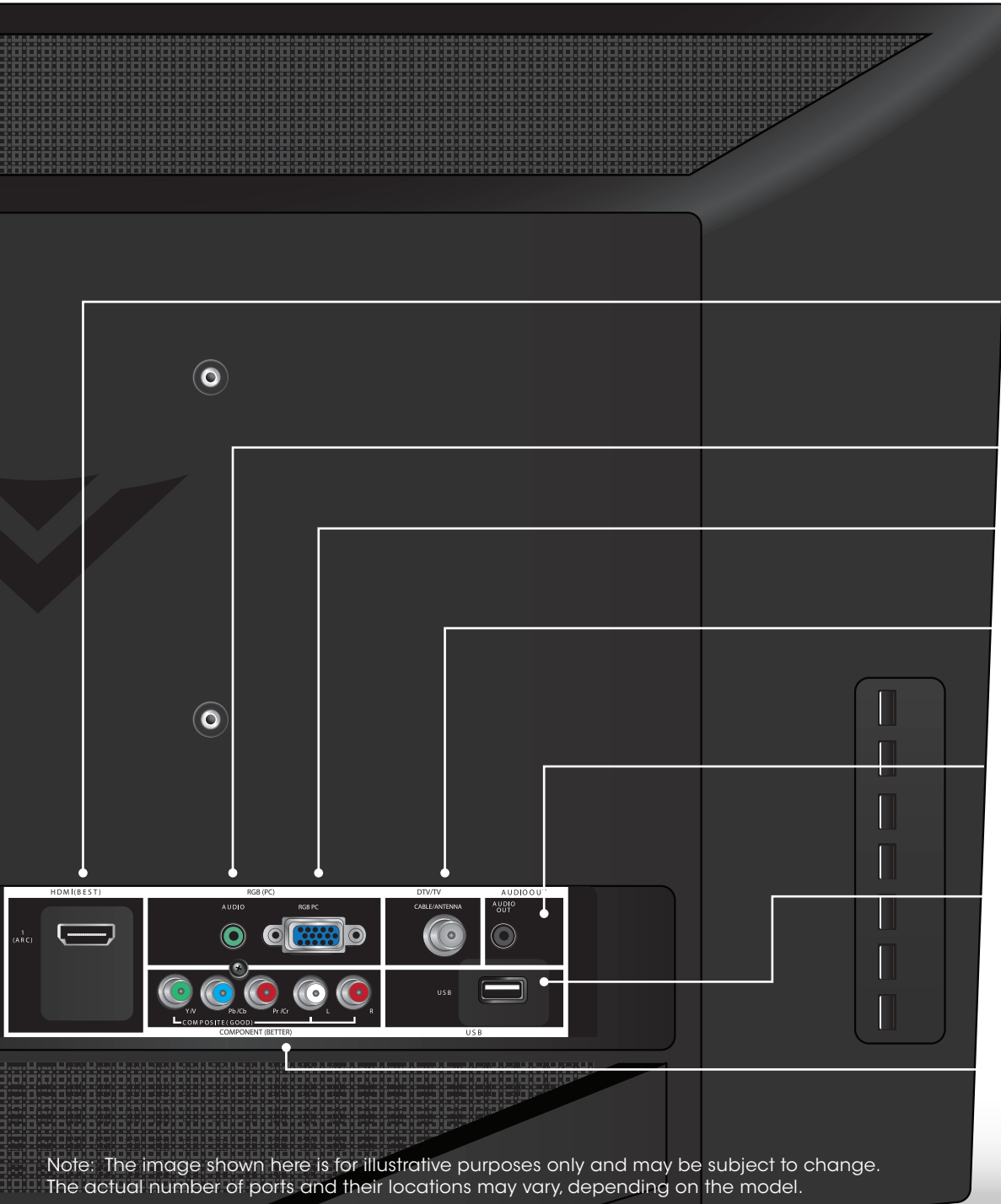

HDMI - Connect HDMI device.

PC Audio In - Connect 3.5mm audio cable from PC.

RGB - Connect VGA cable from PC.

Coaxial - Connect coaxial cable from cable, satellite, or antenna.

Stereo Audio Out - Connect 3.5mm audio device, such as sound bar.

USB - Connect USB thumb drive to play photo, music, or video.

Component/Composite - Connect component or composite device.

REAR PANEL

Note: The image shown here is for illustrative purposes only and may be subject to change. The actual number of ports and their locations may vary, depending on the model.



POWER - Turn TV off or on.

INPUT - Change input source.

MENU - Open the on-screen menu.

CHANNEL UP/DOWN - Change the channel.

VOLUME UP/DOWN - Increase or decrease volume level.

SIDE PANEL



REMOTE SENSOR & POWER INDICATOR
When using the remote, aim it directly at this sensor.

FRONT PANEL

INPUT
Change the currently-displayed input.

EXIT
Close the on-screen menu.

OK
Select the highlighted menu option.

BACK
Go to the previous on-screen menu.

VOLUME UP/DOWN
Increase or decrease loudness of the audio.

MUTE
Turn the audio off or on.

NUMBER PAD
Manually enter a channel.

WIDE
Switch the display mode.



POWER
Turn TV on or off.

MENU
Display the on-screen menu.

ARROW
Navigate the on-screen menu.

GUIDE
Display the info window.

CHANNEL UP/DOWN
Change the channel.

V BUTTON
Open the USB Photo Viewer

LAST
Return to the channel last viewed.

DASH
Use with number pad to manually enter a digital sub-channel. (For example, 18-4 or 18-5.)

Replacing the Batteries

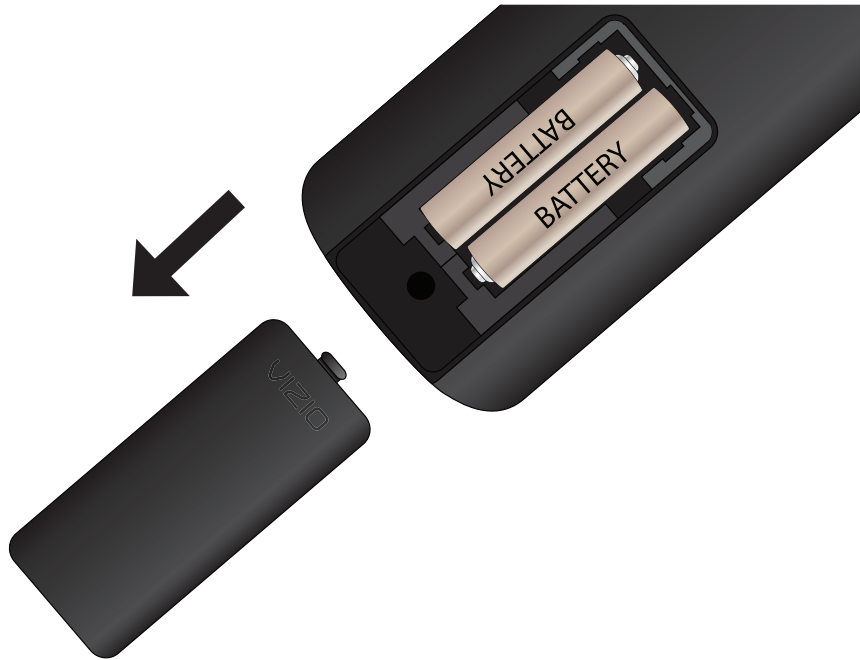

1. Remove the battery cover.
2. Insert two batteries into the remote control. Make sure that the (+) and (-) symbols on the batteries match the (+) and (-) symbols inside the battery compartment.
3. Replace the battery cover.

CONNECTING A DEVICE

Your TV can be used to display output from most devices.

1. Verify that your device has a video port that matches an available port on the TV (HDMI, Component, etc).
2. Turn the TV and your device off.
3. Connect the appropriate cable (not included) to the TV and the device.
4. Turn the TV and your device on. Set the TV's input to match the connection you used (HDMI-1, HDMI-2, etc).



Cable/Satellite Box



Game Console



DVD/Blu-ray Player

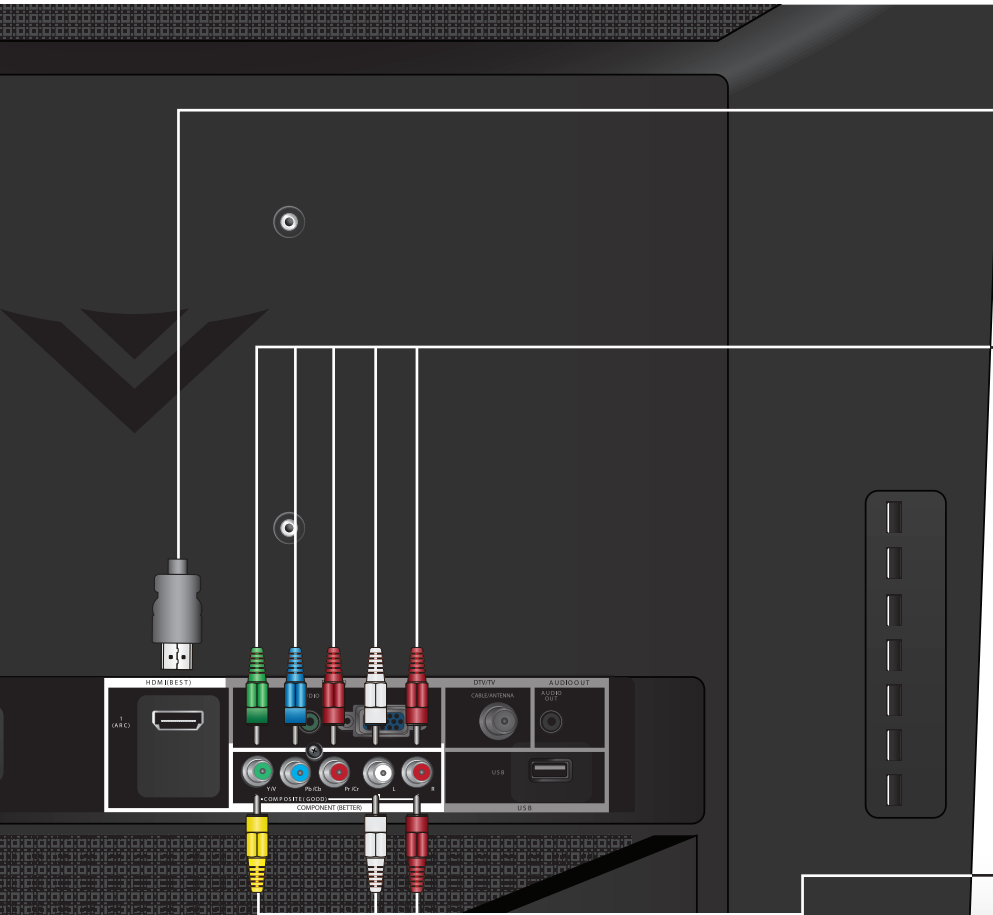

HDMI CABLE
BEST

- DIGITAL
- HD VIDEO (1080p)*
- HD AUDIO



COMPONENT CABLE
BETTER

- ANALOG
- HD VIDEO (1080P)*
- STEREO AUDIO

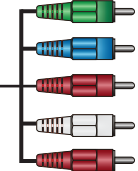

AV CABLE
GOOD

- ANALOG
- VIDEO (480i)*
- STEREO AUDIO

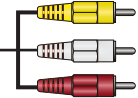

Note: The image shown here is for illustrative purposes only and may be subject to change. The actual number of ports and their locations may vary, depending on the model.

* Maximum Resolution

CONNECTING A DEVICE - AUDIO AND VIDEO CABLE TYPES

AV CABLE

AV cables (or Composite cables) are the traditional way of connecting your devices to your TV. Video signals are sent over the yellow connector while audio is sent over the red and white connectors.

- Video Resolutions up to 480i
- Analog Connection
- Audio and Video Signals

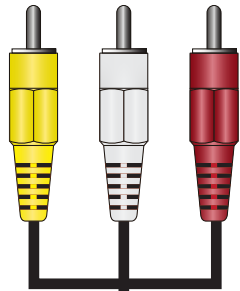

GOOD

COMPONENT CABLE

Component cables are designed to carry high definition video signals along with additional audio connections. Colors are delivered with color information split up three different ways over three connectors for video (separated into Red, Blue and Green signals) and the left and right audio connectors (Red and White).

- HD Video Resolutions up to 1080p
- Analog Connection
- Audio and Video Signals

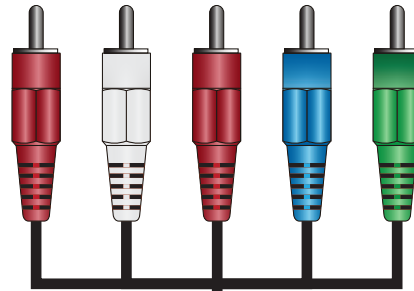

BETTER

HDMI CABLE

HDMI is the intelligent, all-digital interface that delivers both dazzling quality and unmatched ease of use. HDMI technology transmits crystal-clear digital video along with multi-channel surround audio. HDMI-connected devices have the ability to automatically adjust themselves for optimal viewing.

- HD Video Resolutions up to 1080P
- HD Audio
- Digital Connection
- Audio and Video Signals



BEST

CONNECTING AN AUDIO DEVICE

Your TV can output sound to an audio device, such as a receiver or sound bar.

1. Verify that your device has a video port that matches an available port on the TV (Optical, 3.5mm, etc).
2. Turn the TV and your audio device off.
3. Connect the appropriate cable (not included) to the TV and the device.
4. Turn the TV and your device on.

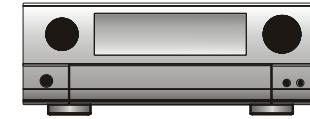

Home Audio Receiver



VIZIO Sound Bar

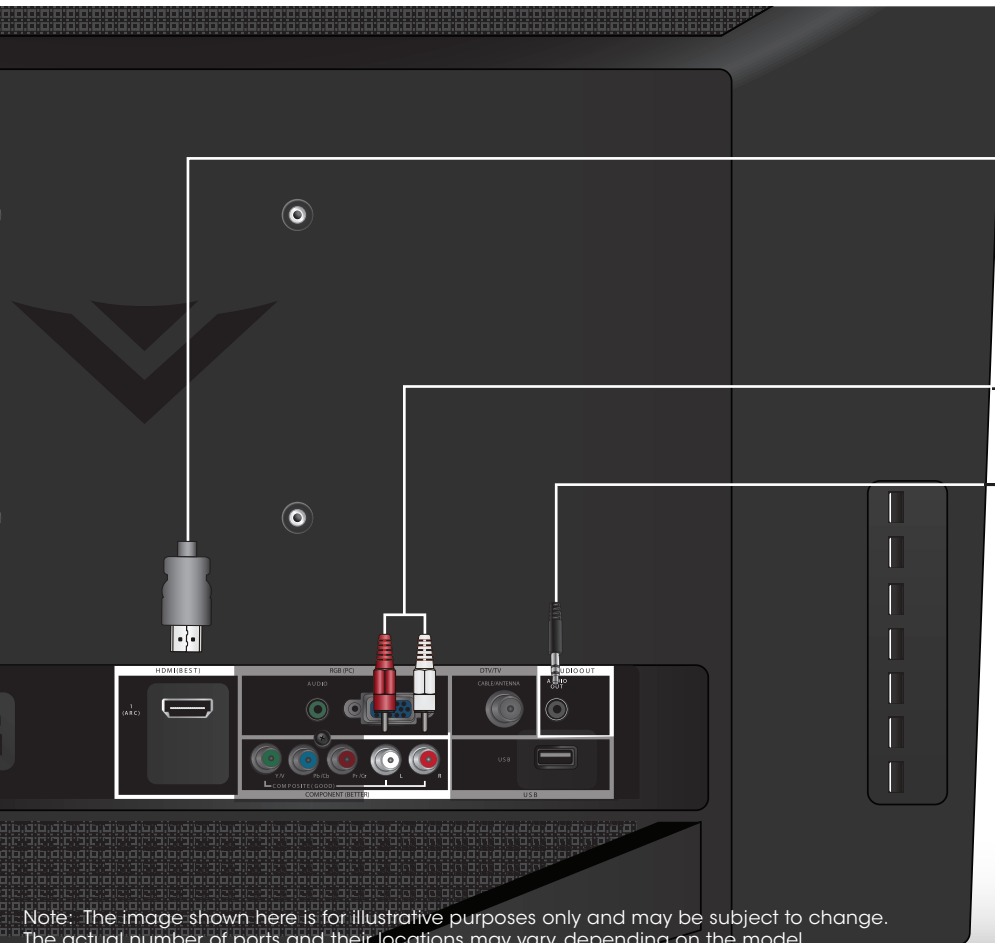

HDMI CABLE
BEST

- CFC 2-WAY COMMUNICATION
- 2.0-5.1 DIGITAL AUDIO
- PCM, DTS, DOLBY DIGITAL



RCA CABLE
GOOD

- ANALOG STEREO CONNECTION
- 2.0 CHANNEL

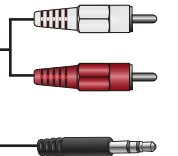

Note: The image shown here is for illustrative purposes only and may be subject to change. The actual number of ports and their locations may vary, depending on the model.

CONNECTING AN AUDIO DEVICE - AUDIO CABLE TYPES

RCA OR 3.5MM CABLE

AV cables (or Composite cables) are the traditional way of connecting your devices to your audio device. Audio signals are sent over the red and white or 3.5mm connectors.

- **Quality Stereo Connection**
- **2.0 Channel**
- **Analog Connection**
- **Audio Signal Only**

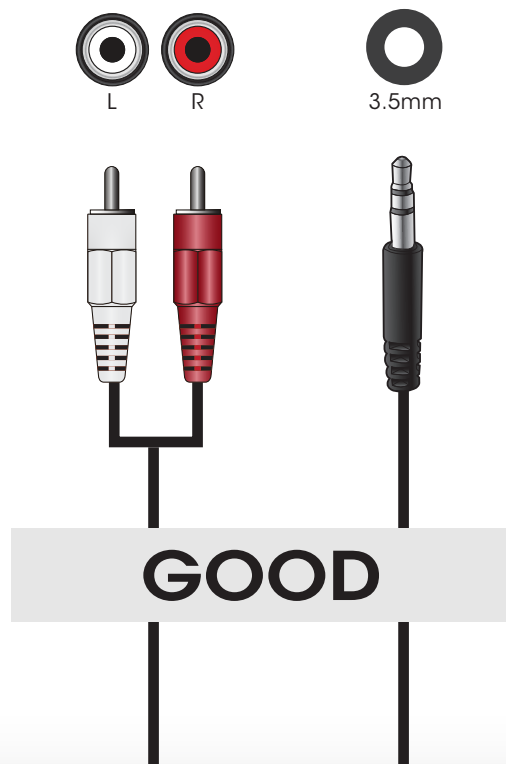

HDMI CABLE

HDMI technology transmits crystal-clear digital multi-channel surround audio through a single HDMI cable. Audio Return Channel-enabled (ARC) TVs allow audio to be sent over an already connected HDMI cable, eliminating the need for a separate audio cable. See *Connecting an Audio Device - ARC* on page 15.

- **CFC 2-way Communication (Auto setup)**
- **PCM, DTS, Dolby Digital**
- **2.0-5.1 Scalable Lossless Digital Audio Connection**
- **Audio and Video Signals**



CONNECTING AN AUDIO DEVICE - ARC

Without HDMI ARC

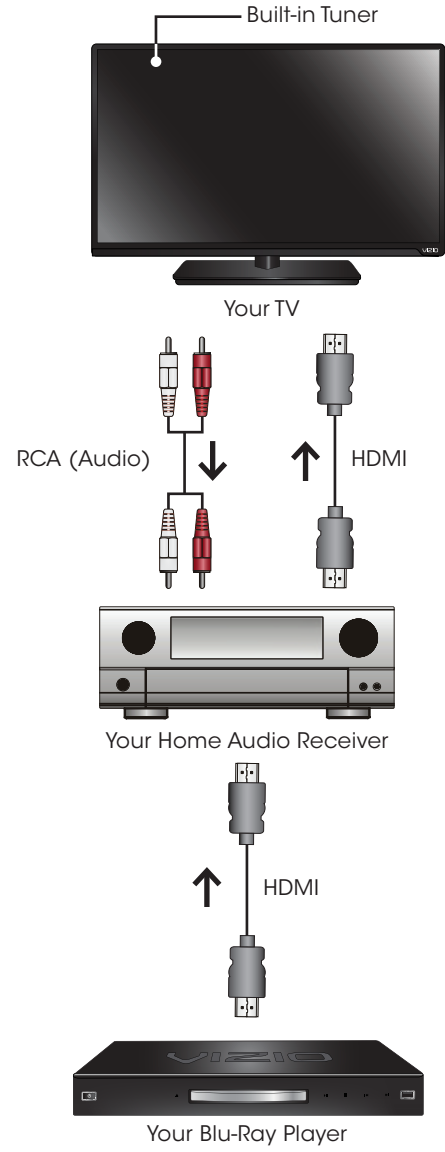

Without an HDMI ARC setup, your TV will transmit audio signal from the built-in tuner and VIA apps to your home audio receiver through a separate audio connection.

With HDMI ARC

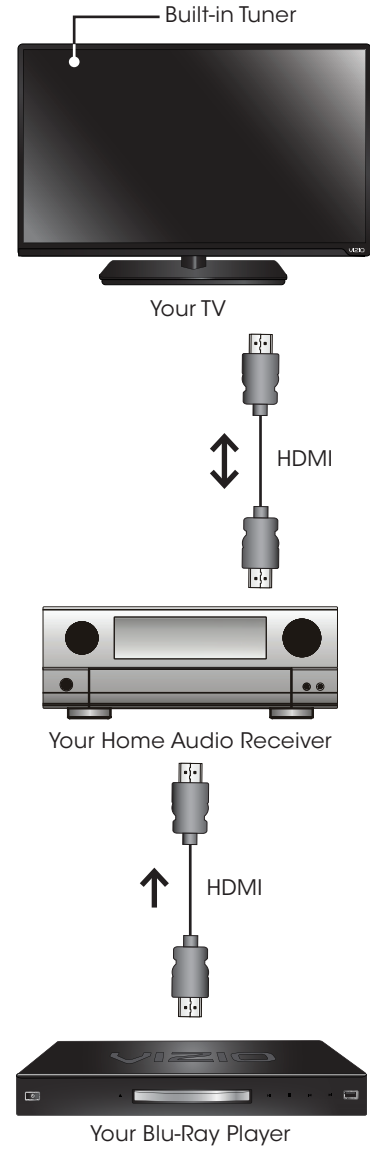

With an HDMI ARC setup, the audio connection between your TV and Home Audio Receiver can be removed. The HDMI cable will transmit audio signal to and from your TV with an all-digital audio/video connection.

The first time you turn on the TV, the Setup App will guide you through each of the steps necessary to get your TV ready for use.

Before you begin the first-time setup:

- Your TV should be installed and the power cord should be connected to an electrical outlet.
- Your devices should be connected.

To complete the first-time setup:

1. Press the **Power/Standby** button on the remote. The TV powers on and the Setup App starts.



2. Use the **Up/Down Arrow** buttons on the remote to highlight your preferred language and press **OK**.

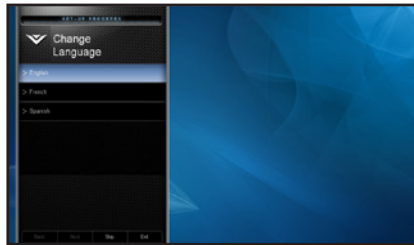

3. Use the **OK** and **Arrow Up/Down** buttons on the remote to highlight **Home Mode** and press **OK**.

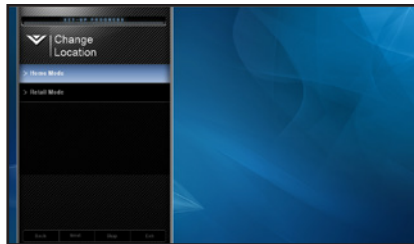

4. Use the **OK** and **Arrow Up/Down** buttons on the remote to highlight your time zone and press **OK**.



5. Use the **OK** and **Arrow Up/Down** Buttons on the remote to turn daylight saving time **On** or **Off**.

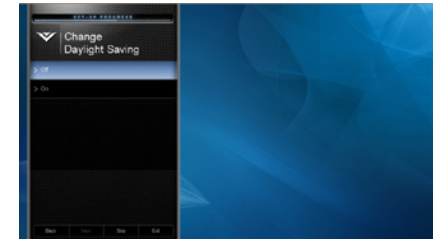

6. Answer the on-screen questions about your TV connection using the **Arrow** and **OK** buttons on the remote.

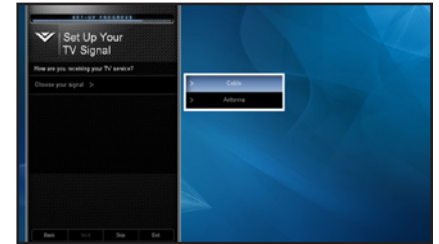

7. Use the **Arrow** buttons to highlight **Start the Channel Scan** and press **OK**.

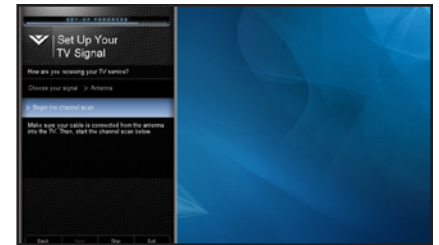

8. When you have finished the channel scan, highlight **Exit to Live TV** and press **OK**.

The First-Time Setup is complete.

Your TV features an easy-to-use on-screen menu.

To open the on-screen menu, press the **MENU** button on the remote. You can also open the on-screen menu by pressing the **VIA** button and selecting **HDTV Settings** from the VIA Dock, then pressing **OK**.

From this menu, you can:

- Change the input source
- Change the screen aspect ratio
- Set up closed captioning
- Activate the sleep timer
- Adjust the picture settings
- Adjust the audio settings
- Change TV settings
- Access the help menu

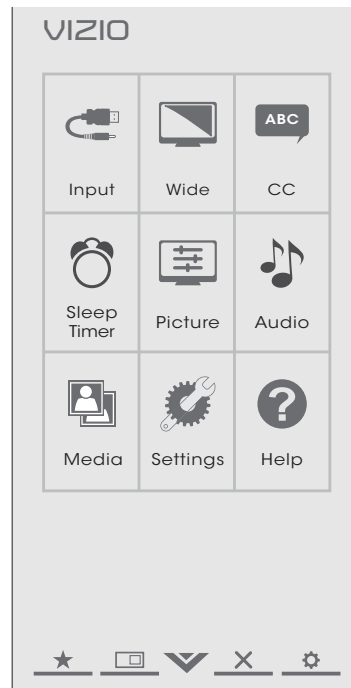

NAVIGATING THE ON-SCREEN MENU

To open the on-screen menu, press the **MENU** button on the remote.

Use the **Arrow** buttons to highlight a menu option, and press the **MENU/OK** button to select that option.



While navigating the on-screen menu, you can press the **BACK** button at any time to return to the previous menu screen. The **EXIT** button will close the on-screen menu.

CHANGING THE INPUT SOURCE

External devices such as DVD players, Blu-Ray Players, and video game consoles can be connected to your TV. To use one of these devices with your TV, you must first change the input source in the on-screen menu.

To change the input device:

1. Press the **MENU** button on the remote. The on-screen menu is displayed.
2. Use the **Arrow** buttons on the remote to highlight the **Settings** icon and press **OK**. The TV Settings menu is displayed.
3. Use the **Up/Down Arrow** buttons on the remote to highlight the input source and press **OK**. The Input Source Selection menu is displayed.
4. Use the **Up/Down Arrow** buttons on the remote to highlight the input source you wish to display and press **OK**.



CHANGING THE SCREEN ASPECT RATIO

The TV can display images in five different modes: Wide, Zoom, Normal, and Stretch. Each mode displays the picture differently.

To change the screen aspect ratio:

5. Press the **MENU** button on the remote.
6. Use the **Arrow** buttons to highlight the **Wide** icon. Press **OK**.
7. Use the **Arrow** buttons to highlight your desired screen mode and press **OK**:
 - **Normal** preserves the content's original aspect ratio. Since the 4:3 aspect ratio is not large enough to fill the TV's screen, black bars are added to the left and right of the display image.
 - **Wide** stretches a 4:3 aspect ratio picture to the edges of the screen. Since the picture is being stretched, the display image may appear distorted. If the program is already formatted for widescreen viewing (1.85:1 or 2.35:1), then black bars will appear on the top and bottom of the display image.
 - **Zoom** expands images with black bars to fit the screen.
 - **Panoramic** expands the display image to fill the screen. Images may appear wider than intended. If you are watching widescreen (1.85:1 or 2.35:1) content, black bars will still appear on the top and bottom of the display image. **This option is only available when the TV is displaying a 480i/480p source.**
 - **Stretch** expands the display image to fill the screen. Images may appear wider than intended. If you are watching widescreen (1.85:1 or 2.35:1) content, black bars will still appear on the top and bottom of the display image. **This option is only available when the TV is displaying a 720p/1080i/1080p source.**

SETTING UP CLOSED CAPTIONING

Your TV can display closed captions for programs that include them. Closed captions display a transcription of a program's dialogue.



If the program you are viewing is not being broadcast with closed captions, the TV will not display them.

To activate or deactivate closed captions:

1. Press the **MENU** button on the remote. The on-screen menu is displayed.
2. Use the **Arrow** buttons on the remote to highlight the **CC** icon and press **OK**. The Closed Caption menu is displayed.
3. Use the **Arrow** buttons on the remote to highlight the type of closed captions you wish to see:
 - **Analog Closed Caption** for analog (NTSC) TV channels.
 - **Digital Closed Caption** for digital (ATSC) TV channels.
4. After highlighting the type of closed captions you wish to see, use the **Left/Right Arrow** buttons on the remote to select the caption channel you wish to display, then press **EXIT**.

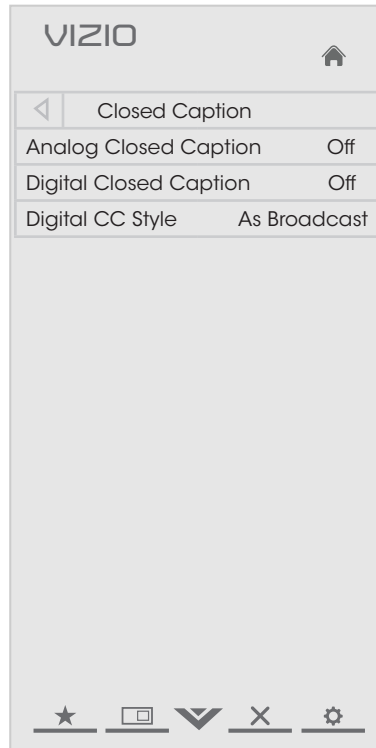

Caption channels usually display different languages. For example, CC1 may display English captions and CC2 may display Spanish captions.

Changing the Appearance of Digital Closed Captions

Digital closed captions can be displayed according to your preference.

To change the appearance of digital closed captions:

1. From the Closed Caption menu, use the **Arrow** buttons to highlight **Digital CC Style**.
2. Use the **Left/Right Arrow** buttons on the remote to select **Custom**, then press **OK**. The Digital CC Style menu appears.
3. Use the **Up/Down Arrow** buttons on the remote to highlight the setting you wish to change, then use the **Left/Right Arrow** buttons to change the setting:
 - **Caption Style** - Choose Auto to keep default settings or Custom to manually change each setting.
 - **Text Size** - Adjust the size of the text.
 - **Color** - Change the color of the text.
 - **Opacity** - Change the transparency of the text.
 - **BG Color** - Change the background color.
 - **BG Opacity** - Change the transparency of the background.
 - **Window Color** - Change the edge color.
 - **Window Opacity** - Change the edge type.
4. When you are satisfied with the appearance of the closed captions, press the **EXIT** button on the remote.

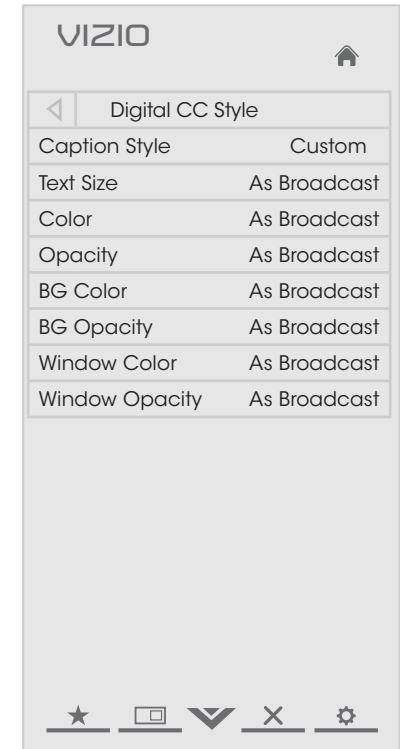

ACTIVATING THE SLEEP TIMER

When activated, the TV's sleep timer will turn the TV off after a set period of time.

To use the sleep timer:

1. Press the **MENU** button on the remote. The on-screen menu is displayed.
2. Use the **Arrow** buttons on the remote to highlight the **Sleep Timer** icon and press **OK**. The Sleep Timer menu is displayed.
3. Use the **Up/Down Arrow** buttons on the remote to highlight **Timer** and press **OK**. The Timers menu is displayed.
4. Use the **Up/Down Arrow** buttons on the remote to highlight the period of time after which you want the TV to turn off: **30, 60, 90, 120, or 180 minutes**. If you don't want the sleep timer to activate, change the setting to **Off**.
5. Press **OK**, then press **EXIT**.

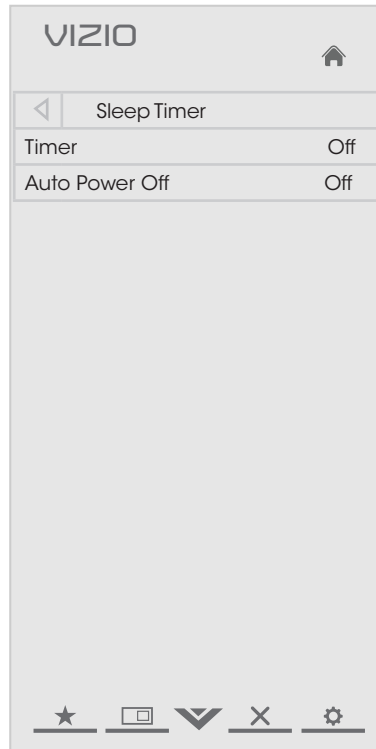

Setting the Auto Power Off Feature

To help save energy, your TV is set by default to turn off after 10 minutes if no signal is being displayed on the screen. This feature can be deactivated.

To set the Auto Power Off feature:

1. From the Sleep Timer menu, use the **Up/Down Arrow** buttons on the remote to highlight **Auto Power Off** and press **OK**. The Auto Power-Off menu is displayed.
2. Highlight **Off** or **10 min** and press **OK**. Press **Exit**.

ADJUSTING THE PICTURE SETTINGS

Your TV display can be adjusted to suit your preferences and viewing conditions.

To adjust the picture settings:

1. Press the **MENU** button on the remote. The on-screen menu is displayed.
2. Use the **Arrow** buttons on the remote to highlight the **Picture** icon and press **OK**. The Picture Settings menu is displayed.
3. Use the **Up/Down Arrow** buttons on the remote to highlight **Picture** and press **OK**. The Picture Settings menu is displayed.
4. Use the **Arrow** buttons on the remote to highlight **Picture Mode**, then use the **Left/Right Arrow** buttons to change the picture mode:
 - **Standard mode** sets the various picture settings to values that will produce the best picture in the most cases. This is the recommended setting.
 - **Movie mode** sets the picture settings to values perfect for watching a movie in a dark room.
 - **Game mode** optimizes the picture settings for displaying game console output.
 - **Vivid mode** sets the picture settings to values that produce a brighter, more vivid picture.

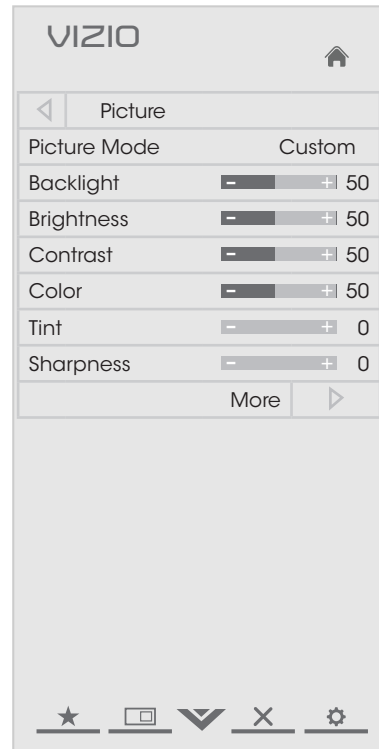

- **Football, Golf, Basketball, and Baseball** modes optimize the picture settings for their respective sports. Also try these modes for other sports.
- **Custom** picture mode allows you to manually change each of the picture settings:

Backlight - Adjusts the LED brightness to affect the overall brilliance of the picture.

Brightness - Adjusts the black level of the picture. When this setting is too low, the picture may be too dark to distinguish details. When this setting is too high, the picture may appear faded or washed out.

Contrast - Adjusts the white level of the picture. When this setting is too high, the picture may appear dark. When this setting is too low, the picture may appear faded or washed out. If the setting is too high or too low, detail may be difficult to distinguish in dark or bright areas of the picture.

Color - Adjusts the intensity of the picture colors.

Tint - Adjusts the hue of the picture. This setting is useful in adjusting the flesh tones in the picture. If flesh appears too orange, reduce the level of color before adjusting tint.

Sharpness - Adjusts the edge sharpness of picture elements. It can be used to sharpen non-HD (high definition) content; however, it will not produce detail that does not otherwise exist.

Adjusting the Advanced Picture Settings

To adjust the advanced picture settings:

1. From the Picture Settings menu, use the **Arrow** buttons on the remote to highlight **More**, then press **OK**.
2. Use the **Arrow** buttons on the remote to highlight **Advanced Picture**, then press **OK**. The Advanced Picture menu is displayed.
3. Use the **Arrow** buttons to highlight the setting you wish to adjust, then press **Left/Right Arrow** to change the setting:

- **Noise Reduction** - Diminishes artifacts in the image caused by the digitizing of image motion content. Select Off, Low, Medium, or High.
- **MPEG NR** - Reduces pixellation and distortion for .mpeg files. Select Off, Low, Middle, or High.
- **Color Enhancement** - Reduces oversaturation of some colors and improves flesh tones. Select Off, Normal, Rich Color, Green/Flesh, or Green/Blue.
- **Adaptive Luma** - Adjusts the average brightness of the picture to compensate for large areas of brightness. Select Off, Low, Medium, Strong, or Extend.
- **Film Mode** - Optimizes the picture for watching film. Select Auto or Off.

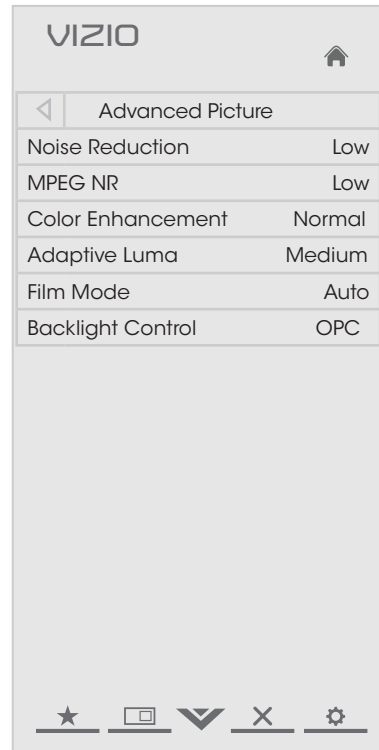

- **Backlight Control** - Select Off or OPC.

4. When you have finished adjusting the Advanced Picture Settings, press the **EXIT** button on the remote.

Adjusting the Color Temperature

Adjusting the color temperature will change the “warmness” or “coolness” of the white areas of the picture.

To adjust the color temperature:

1. From the Picture Settings Menu, use the **Arrow** buttons to highlight **More**, then press **OK**.
2. Use the **Arrow** buttons on the remote to highlight **Color Temperature**, then press **OK**. The Color Temperature menu is displayed.
3. Use the **Arrow** buttons on the remote to highlight **Color Temperature**, then use the **Left/Right Arrow** buttons to change the color temperature preset:
 - **Cool** produces a blue-hued picture.
 - **Computer** optimizes the picture for use as a PC monitor.
 - **Normal** is optimized for television viewing.
 - **Custom** allows you to manually change each of the color temperature settings:

Red/Green/Blue Gain - Adjusts the amount of each color in the display.

Red/Green/Blue Offset - Adjusts the position of each color in the display.

4. If you want to reset the color temperatures to the factory default settings, highlight **Reset Color Temperature** and press **OK**.
5. When you have finished adjusting the color temperature, press the **EXIT** button on the remote.

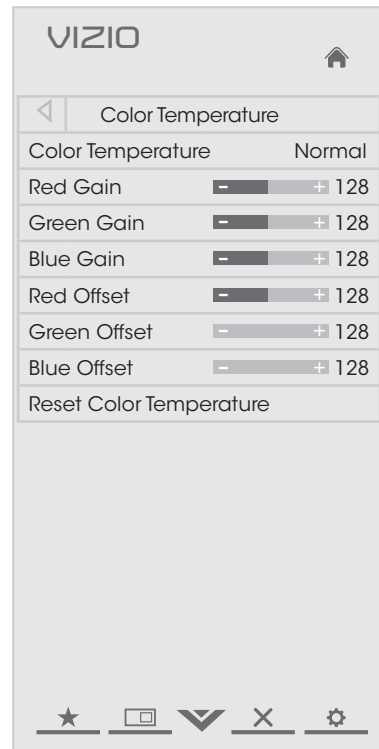

Adjusting the Picture Size and Position

When displaying an image from the HDMI input, the size and position of the display image can be adjusted.

To adjust the picture size and position:

1. Ensure the input is set to **AV**, **HDMI** or **RGB**.
2. From the Picture Settings menu, use the **Arrow** buttons on the remote to highlight **More**, then press **OK**.
3. Use the **Arrow** buttons on the remote to highlight **Size & Position**, then press **OK**. The Size & Position menu is displayed.
4. Use the **Arrow** buttons to highlight the setting you wish to adjust, then press **Left/Right Arrow** to change the setting:
 - **Horiz. Position** - Adjusts the horizontal (left/right) position of the display image.
 - **Vertical Position** - Adjusts the vertical (up/down) position of the display image.
 - **Horizontal Size** - Adjusts the width of the display image.
 - **Vertical Size** - Adjusts the height of the display image.
5. When you have finished adjusting the color temperature, press the **EXIT** button on the remote.

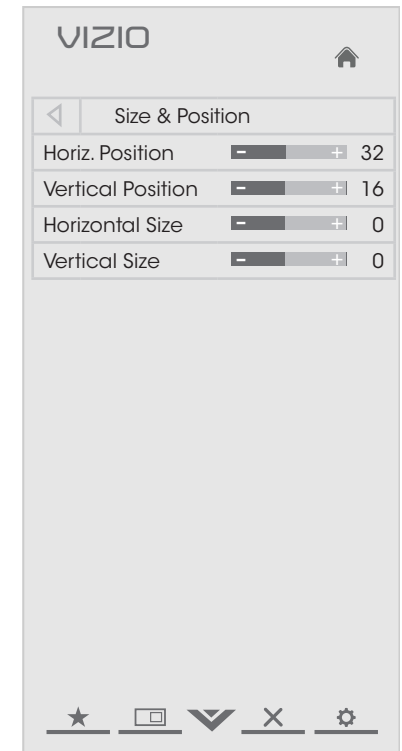

Resetting the Picture Settings

To reset the picture settings to the factory default settings:

1. From the Picture Settings menu, use the **Arrow** buttons to highlight **More**, then press **OK**.
2. Use the **Arrow** buttons on the remote to highlight **Reset Picture Mode**, then press **OK**. The TV displays, "Are you sure you want to RESET Picture Settings to the factory defaults?"
3. Highlight **Yes** and press **OK**.
4. Press the **EXIT** button on the remote.

ADJUSTING THE AUDIO SETTINGS

To adjust the audio settings:

1. Press the **MENU** button on the remote. The on-screen menu is displayed.
2. Use the **Arrow** buttons on the remote to highlight **Audio** and press **OK**. The Audio Settings menu is displayed.
3. Use the **Arrow** buttons to highlight the setting you wish to adjust, then press **Left/Right Arrow** to change the setting:
 - **Balance** - Adjusts the loudness of the audio output from the left and right speakers.
 - **Lip Sync** - Adjusts the synchronization between the display image and the accompanying audio track.
 - **TV Speakers** - Turns the built-in speakers on or off.
 - **SRS StudioSound HD** - StudioSound HD™ is a feature-rich surround sound solution which delivers an immersive surround sound experience from the TV's internal speakers. Additionally, StudioSound HD completes the entertainment experience by maintaining a steady volume while watching programming and movies, providing deep, rich bass, and delivering crisp details and clear, intelligible dialog. Select Surround or Standard.
 - **SRS TruVolume** - TruVolume® intelligently normalizes volume fluctuations due to television commercials or channel changes. Select On or Off.

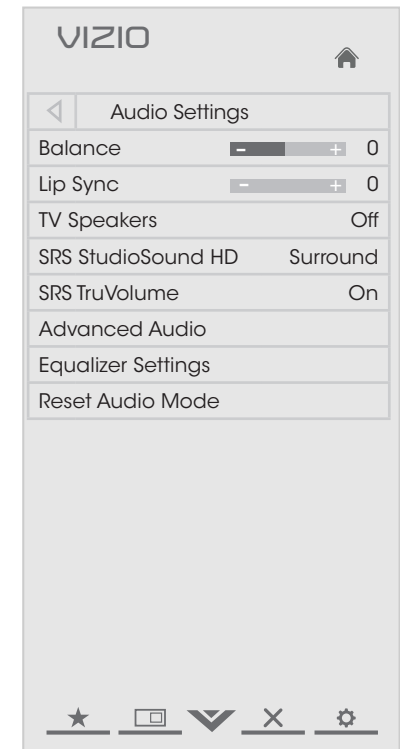

- **Advanced Audio** - See *Adjusting the Advanced Audio Settings* on page 25.
 - **Equalizer Settings** - Adjusts the boost or attenuation of different frequencies. (This setting is only available when SRS TruSurround HD is set to Standard.) Change the equalizer presets by selecting Jazz, Classical, Pop, Rock, or Flat. To change the equalizer settings yourself, highlight **EQ Mode** and press **OK**.
 - **Reset Audio Mode** - Restores the audio settings to the factory defaults. See *Adjusting the Audio Settings* on page 24.
4. When you have finished adjusting the audio settings, press the **EXIT** button on the remote.

Adjusting the Advanced Audio Settings

To adjust the advanced audio settings:

1. From the Audio Settings Menu, use the **Arrow** buttons to highlight **Advanced Audio**, then press **OK**. The Advanced Audio menu is displayed.
2. Use the **Arrow** buttons to highlight the setting you wish to adjust, then press **Left/Right Arrow** to change the setting:
 - **Digital Audio Out** - Changes the type of processing for the Optical output or HDMI ARC output when connected to a home theater audio system. Select Off, Dolby Digital, or PCM.
3. When you have finished adjusting the advanced audio settings, press the **EXIT** button on the remote.

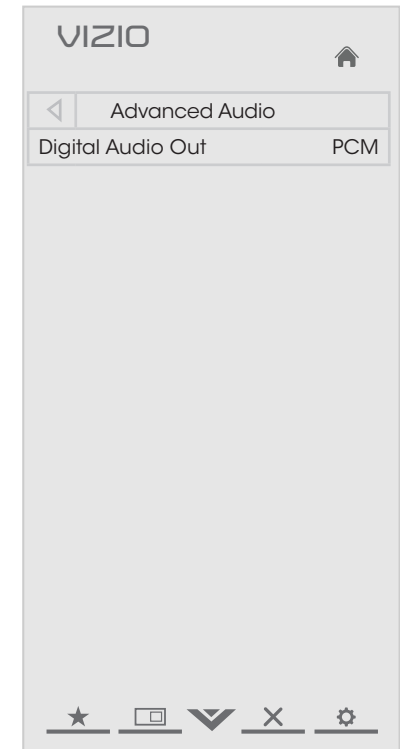

CHANGING THE TV SETTINGS

Using the settings menu, you can:

- Change the input source
- Adjust the Tuner settings
- Name the TV inputs
- Set up parental controls
- Change the on-screen menu language
- Set the time
- Adjust the CEC settings
- Adjust the Power Light settings

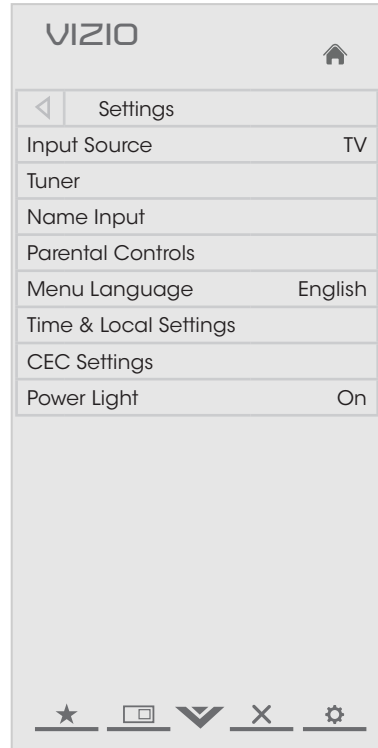

Changing the Input Source

To change the input source from the Settings menu:

1. Press the **MENU** button on the remote. The on-screen menu is displayed.
2. Use the Arrow buttons on the remote to highlight the Settings icon and press OK. The Settings menu is displayed.
3. Highlight Input Source and press OK. The Input Source menu is displayed.
4. Highlight the input source you want to display and press **OK**.

Setting the Tuner Mode

If you are using a device that is connected to the RF input, such as an external antenna or cable TV connection, you must set the tuner mode.

1. Press the **MENU** button on the remote. The on-screen menu is displayed.
2. Use the **Arrow** buttons on the remote to highlight the **Settings** icon and press **OK**. The Settings menu is displayed.
3. Highlight **Tuner** and press **OK**. The Tuner Mode menu is displayed.
4. Highlight **Antenna** or **Cable** and press **OK**.
5. Press the **EXIT** button on the remote.

Scanning for Channels



To quickly access the Input Source menu, press the **INPUT** button on the remote.

Before the TV can detect and display channels and their associated information, you must scan for channels. A channel scan may also be necessary when the TV has been moved to an area where different free-to-air broadcast television channels are available.

1. From the Tuner Settings menu, highlight **Auto Channel Scan**. The auto channel scan begins.
2. Wait until the channel scan is 100% complete. Highlight **Done** and press **OK**.
3. Press the **EXIT** button on the remote.

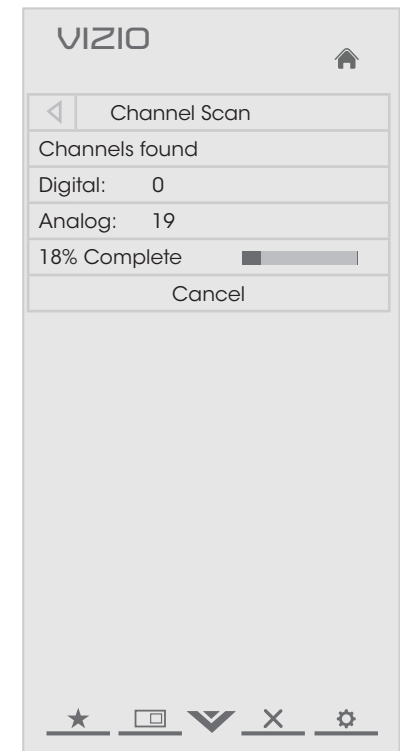

Adding New Channels

Occasionally, you may need to add a new analog channel or add a new range of channels. You can do this by using the Partial Channel Search and Add Analog Channel options.

To add a range of new channels:

1. From the **Tuner** menu, highlight **Partial Channel Search**. The Partial Channel Search menu is displayed.
2. Highlight **Scan Mode** and select the type of channel you are adding: **Analog/Digital, Analog, or Digital**.
3. Highlight **From Channel** and enter the channel from which you want to begin the scan. (Use the **Number Pad** on the remote to enter the channel.)
4. Highlight **To Channel** and enter the channel to which you want to end the scan. (Use the **Number Pad** on the remote to enter the channel.)
5. Highlight **Start** and press **OK**. The partial channel search begins.
6. Wait until the partial channel search is 100% complete. Highlight **Done** and press **OK**.
7. Press the **EXIT** button on the remote. Cancel the Scan

To add a single new analog channel:

1. From the Tuner Settings menu, highlight **Add Analog Channel** and press **OK**. The **Add Analog Channel** menu is displayed.
2. Highlight **Enter Channel #** and use the **Number Pad** on the remote to enter the number of the channel you are adding.
3. Highlight **Add Channel** and press **OK**. The TV scans for the channel.
4. When the TV is done scanning for the channel, press the **EXIT** button on the remote.

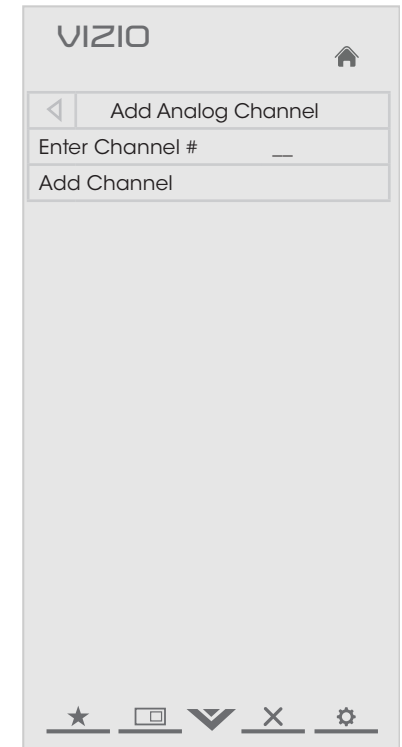

Skipping Channels

After a channel scan is completed, you may find that some channels are too weak to watch comfortably. There may also be some channels you do not want to view. You can remove these channels from the TV's memory with the Skip Channel feature.



Channels that have been removed with the Skip Channel feature can still be viewed if the channel is entered using the Number Pad. If you wish to completely block a channel from being viewed, use the parental controls. See *Using the Parental Controls* on page 30.

To remove a channel:

1. From the Tuner Settings menu, highlight **Skip Channel**. The **Skip Channel** menu is displayed.
2. For each channel you wish to remove, use the **Up/Down Arrow** buttons on the remote to highlight the channel and press **OK**. An X appears to the right of each channel you select.
3. When you have selected all of the channels you wish to remove, press the **EXIT** button on the remote.

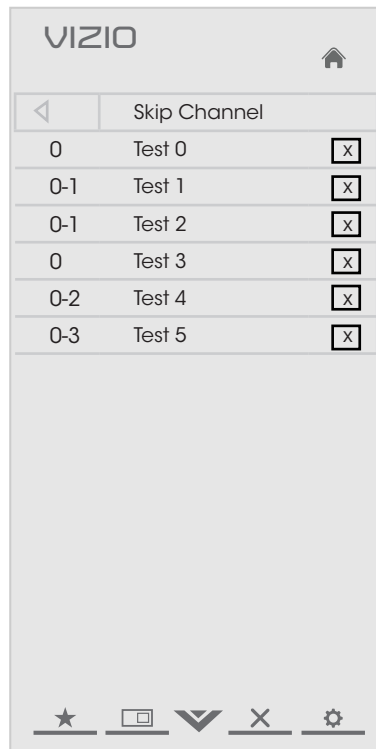

Changing the Audio Language

Some digital free-to-air and cable channels broadcast programs in more than one language. The TV's MTS (Multichannel Television Sound) feature allows you to listen to audio in your preferred language.



Not all programs are broadcast in multiple languages. The MTS feature only works when the program being viewed is being broadcast in the language you select.

To use the Analog MTS feature:

1. From the Tuner Settings menu, highlight **Analog MTS** and press **OK**. The **Analog MTS** menu is displayed.
2. Select **Mono**, **Stereo**, or **SAP** (secondary audio programming). Press **OK**.
3. Press the **EXIT** button on the remote.

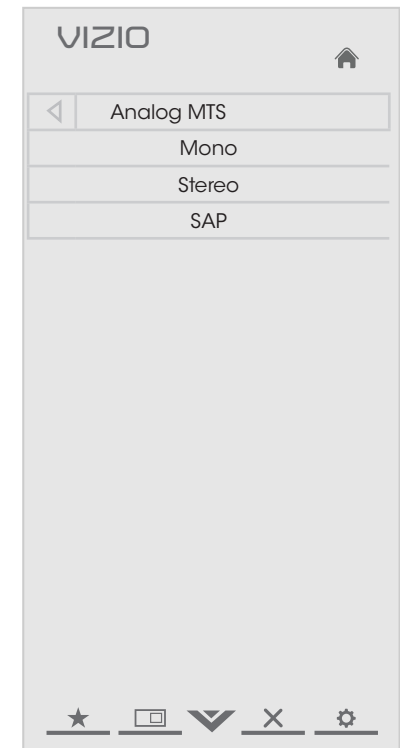

To use the Digital MTS feature:

1. From the Tuner Settings menu, highlight **Digital MTS** and press **OK**. The **Digital MTS** menu is displayed.
2. Select your preferred language: **English, French, or Spanish**. Press **OK**.
3. Press the **EXIT** button on the remote.

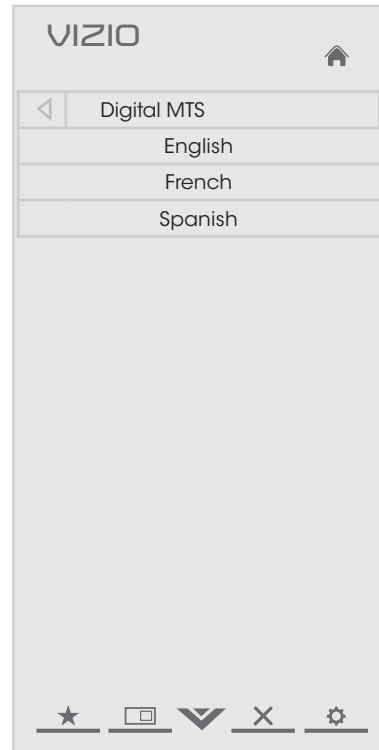

Using the Parental Controls

The TV's parental controls allow you to prevent the TV from displaying certain channels or programs without a password.

Accessing the Parental Controls Menu

To access the Parental Controls menu:

1. Press the **MENU** button on the remote. The on-screen menu is displayed.
2. Use the **Arrow** buttons on the remote to highlight the **Settings** icon and press **OK**. The TV Settings menu is displayed.
3. Use the **Arrow** buttons on the remote to highlight **Parental Controls** and press **OK**.
4. Enter your parental passcode. If you have not set a passcode, enter the default, **0000**. The Parental Controls menu is displayed.



To set a custom parental passcode, see *Changing the Parental Control Passcode* on page 32.

Enabling or Disabling Program Ratings

To manage program content according to its rating, you must enable the Program Rating feature.

To enable or disable the Program Rating feature:

1. From the Parental Controls menu, highlight **Rating Enable** and press **OK**. The Rating Enable menu is displayed.
2. Select **On** or **Off** and press **OK**.

Locking and Unlocking Channels

When a channel is locked, it will be inaccessible. Locking a channel is a good way to prevent children from viewing inappropriate material.

To lock or unlock a channel:

1. From the Parental Controls menu, highlight **Channel Locks** and press **OK**. The Channel Locks menu is displayed.
2. Highlight the channel you want to lock or unlock and press **OK**.
3. When a channel is **locked**, the **Lock** icon appears **locked**. The channel is not accessible unless the parental passcode is entered.
4. When a channel is **unlocked**, the **Lock** icon appears **unlocked**. The channel is accessible.

Blocking and Unblocking Content by Rating

A channel may sometimes broadcast programs that are meant for children, and at other times broadcast programs that are meant for mature audiences. You may not want to block the channel completely using a channel lock, but you may wish to block certain programs from being viewed.



For a list of content ratings and their definitions, visit www.tvguidelines.org.

To block or unblock content by its rating:

1. From the Parental Controls menu, highlight the content type you want to adjust and press **OK**:

USA - TV - USA television program broadcasts.

USA - Movie - USA movie broadcasts.

CAN - English - Canadian English television program broadcasts.

CAN - French - Canadian French television program broadcasts.

2. For each rating type you want to block or unblock, use the **Up/Down** and **Left/Right Arrow** buttons on the remote to highlight the rating type and press **OK**.
3. When the rating type is **blocked**, the **Lock** icon appears **locked**. Content with this rating cannot be viewed.
4. When the rating type is **unblocked**, the **Lock** icon appears **unlocked**. Content with this rating can be viewed.

If you want to block all unrated content, highlight **Block Unrated Shows** and use the **Arrow** buttons on the remote to select **On**.

5. When you are finished adjusting the rating level blocks, press the **EXIT** button on the remote.

Changing the Parental Control Passcode

If you use the parental controls, you should change the passcode to prevent children from accessing inappropriate material.

1. From the Parental Controls menu, highlight **Change PIN** and press **OK**. The **Change PIN** menu is displayed.
2. In the **New Pin** field, use the **Number Pad** on the remote to enter your new 4-digit parental control passcode.
3. In the **Confirm Pin** field, use the **Number Pad** on the remote to re-enter your new 4-digit parental control passcode.
4. Write down your new parental control passcode and save it in a secure location.
5. Press the **EXIT** button on the remote.

Resetting the Content Locks

To reset the content locks to the factory-default settings:

1. From the Parental Controls menu, highlight **RESET LOCKS** and press **OK**. The TV displays, "Are you sure you want to RESET ALL LOCKS SETTINGS to the factory defaults?"
2. Highlight **Yes** and press **OK**.

Changing the Names of the Inputs

To make it easier to recognize the different devices attached to the inputs on your TV, you can rename the inputs. For example, if you have a DVD player connected to the Component input, you can rename that input to display "DVD Player".

To change the name of an input:

1. Press the **MENU** button on the remote. The on-screen menu is displayed.
2. Use the **Arrow** buttons on the remote to highlight the **Settings** icon and press **OK**. The Settings menu is displayed.
3. Use the **Arrow** buttons on the remote to highlight **Name Input** and press **OK**. The Name Input menu is displayed.
4. Highlight **Input Source** and press **OK**. Highlight the input you want to rename and press **OK**.
5. If you would like to use a preset input label, highlight **Input Labels** and press **OK**. Highlight the input label you want to use and press **OK**.
6. When you have finished naming your input, press the **EXIT** button on the remote.

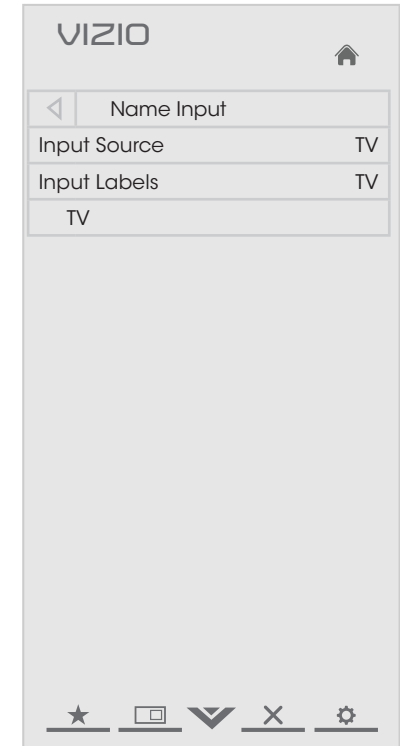

Changing the On-Screen Menu Language

Your TV can display the on-screen menu in different languages.

To change the on-screen menu language:

1. Press the **MENU** button on the remote. The on-screen menu is displayed.
2. Use the **Arrow** buttons on the remote to highlight the **Settings** icon and press **OK**. The Settings menu is displayed.
3. Use the **Arrow** buttons on the remote to highlight **Menu Language** and press **OK**. The Menu Language menu is displayed.
4. Highlight your preferred language (**English**, **French**, or **Spanish**) and press **OK**.
5. Press the **EXIT** button on the remote.

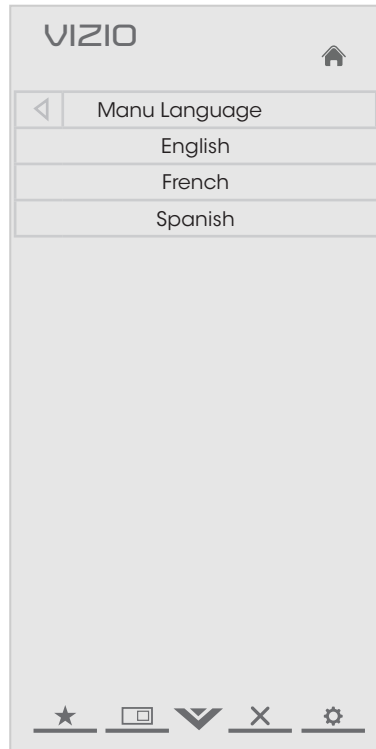

Setting the Time Zone

To ensure the correct time is displayed when you press the INFO button, set the TV's time zone:



To have the TV display the correct time, you must be connected to the internet via an Ethernet cable or a wireless network.

1. Press the **MENU** button on the remote. The on-screen menu is displayed.
2. Use the **Arrow** buttons on the remote to highlight the **Settings** icon and press **OK**. The Settings menu is displayed.
3. Use the **Arrow** buttons on the remote to highlight **Time & Local Settings** and press **OK**. The Time & Local Settings menu is displayed.
4. Highlight **Time Zone** and press **OK**. The Time Zone menu is displayed.
5. Highlight your time zone and press **OK**.
6. Highlight **Daylight Savings** and press **OK**. The Daylight Savings menu is displayed. Choose **On** if daylight savings is in effect, or **Off** if it is not.
7. Highlight **Postal Code**. Enter your ZIP code using the keypad on the remote, then press **OK**. The ZIP code information is often used by VIA Apps to give you the most accurate location-based information, such as weather or news.
8. Press the **EXIT** button on the remote.



Adjusting the CEC Settings

The CEC function on your TV enables you to control HDMI-connected devices with the included remote without any additional programming.



Not all HDMI devices support CEC. See your device's user manual for details.

To enable, disable, or adjust CEC settings:

1. Press the **MENU** button on the remote. The on-screen menu is displayed.
2. Use the **Arrow** buttons on the remote to highlight the **Settings** icon and press **OK**. The Settings menu is displayed.
3. Use the **Arrow** buttons on the remote to highlight **CEC Settings** and press **OK**. The CEC Settings menu is displayed.
4. Use the **Arrow** and **OK** buttons to adjust each setting:
 - **CEC Function** - To use CEC, you must select **Enable**.
 - **System Audio Control** - When system audio control is on, you can control your device's audio using the TV's remote control.
 - **Device Discovery** - Use this function to determine if your device is connected and supports CEC.
5. Press the **EXIT** button on the remote.

Turning the Power Indicator Light On or Off

The Power Indicator Light on the front of your TV is set to light up when the TV is on. You can change this setting if you prefer the light to be off.

To turn the Power Indicator Light on or off:

1. Press the **MENU** button on the remote. The on-screen menu is displayed.
2. Use the **Arrow** buttons on the remote to highlight the **Settings** icon and press **OK**. The Settings menu is displayed.
3. Highlight **Power Indicator** and press **OK**.
4. Use the **Up/Down Arrow** buttons to select **On** or **Off**, then press **OK**.

USING THE HELP MENU

You can use the TV's Help menu to:

- Display system information
- Reset the TV settings
- Restore the TV to its factory default settings
- Start the Setup Wizard

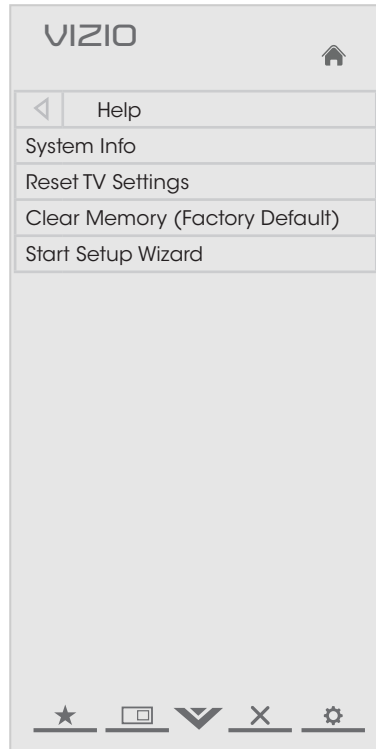

Displaying System Information

To display a summary of the TV settings:

5. Press the **MENU** button on the remote. The on-screen menu is displayed.
6. Use the **Arrow** buttons on the remote to highlight the **Help** icon and press **OK**. The Help menu is displayed.
7. Highlight **System Info** and press **OK**.
8. Use the **Up/Down Arrow** buttons to scroll through the system information.
9. When you are finished reviewing the system information, press the **EXIT** button on the remote.

Resetting the TV Settings

To reset the TV's picture and audio settings:

1. Press the **MENU** button on the remote. The on-screen menu is displayed.
2. Use the **Arrow** buttons on the remote to highlight the **Help** icon and press **OK**. The Help menu is displayed.
3. Highlight **Reset TV Settings** and press **OK**. The TV displays, "Are you sure you would like to Restore Defaults? This will erase any custom settings."
4. Highlight **Yes** and press **OK**.
5. Press the **EXIT** button on the remote.

Restoring the TV to Factory Default Settings

All of the on-screen menu settings can be reset to the factory defaults.



If you restore the TV to the factory default settings, all changes you have made to the settings will be lost!

To restore the TV to its factory default settings:

1. Press the **MENU** button on the remote. The on-screen menu is displayed.
2. Use the **Arrow** buttons on the remote to highlight the **Help** icon and press **OK**. The Help menu is displayed.
3. Highlight **Clear Memory (Factory Default)** and press **OK**.
4. Enter your parental control passcode. If you have not yet set up a parental passcode, enter the default, **0000**.

The TV displays, "Are you sure you would like to Restore Defaults? This will erase any custom settings."

5. Highlight **Yes** and press **OK**. The TV displays "Memory is being cleared. The TV will reset shortly."
6. Wait for the TV to turn off. The TV will turn back on shortly afterward and the Setup App will begin.

USING THE INFO WINDOW

The Info Window can be displayed by pressing the INFO or GUIDE button on the remote:

- Press the INFO or GUIDE button one time to display channel and input information.
- Press the INFO or GUIDE button two times to display the program title and closed captioning information.
- Press the INFO or GUIDE button three times to display the program description.

Program Title/CC Information

Channel/Input Information

Oliver's Holiday Surprise			Ch 50-123	LACT DTV	CABLE
11:00AM - 12:00PM	TV-PG (V)	CC-OFF	ENGLISH	DOLBY 5.1	720p HD
Oliver wakes up one morning only to discover that his pals are missing. In this hour-long holiday special, Oliver goes on a journey in search of his pals. Who knows what he'll encounter on the way?					

Program Description

DIGITAL EPISODE GUIDE & INFO WINDOW

USING THE USB MEDIA PLAYER

The USB Media Player allows you to connect a USB thumb drive to your TV and play music or photos.

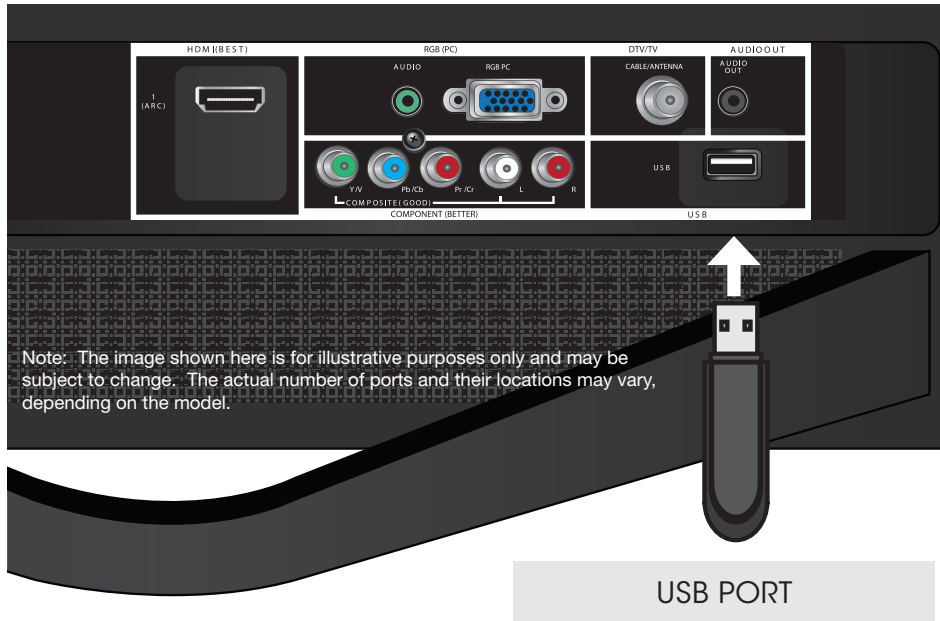

Connecting a USB Thumb Drive to the TV

1. Turn the TV off. Connect your USB thumb drive to the USB port on the back of the TV.
2. Press the **Power/Standby** button on the remote or touch the **Power** control on the side of the TV to turn it on.



Do not remove the USB thumb drive while the TV is on. Doing so may damage the drive.

Playing USB Media

To play USB media, you must first save your music or images onto a USB thumb drive.

Remember:

- The USB thumb drive must be formatted as FAT32.
- Only jpeg files are supported.
- The player is not designed to play media from external hard drives or mp3 players.

To play your USB media:

1. Connect your USB thumb drive to the USB port on the side of the TV.
2. Highlight the **Media App** and press **OK**. The Media App launches.
3. Highlight your USB device in the list and press **OK**.
4. Highlight **Photo** and press **OK**.
5. Use the **Arrow** buttons to highlight the file you want to display. Press **OK**. The file plays.



You can display your photos in fullscreen. Select the photo, press OK, then highlight Fullscreen and press OK.

Connected Sources

Displays connected USB devices. To change source, highlight it and press **OK**.

Back Button

Highlight this button and press **OK** if you would like to return to the previous screen.

Back Button

Highlight and press **OK** to return to left column.

Current Folder

Displays the folder path.

Folder Contents

This area displays the contents of the currently selected folder. You can browse between files using the **Arrow** and **OK** buttons on the remote.

Current Folder

Start Fullscreen Slideshow

Sort by Name

View Thumbnails/List

View Folder Settings



Photo Information

Displays name, resolution, and file size for currently selected photo.

Page Information

If your USB thumb drive has more files than can be displayed on a single screen, you can move between pages by highlighting this area and pressing **Left/Right Arrow**.

DO YOU HAVE QUESTIONS?
LET US HELP!

YOUR PRODUCT INCLUDES FREE LIFETIME TECH SUPPORT

The VIZIO support team is highly trained and is based in the United States.

We can help with:

- New Product Setup
- Connecting Your Devices
- Technical Problems
- And More

Phone: (877) 878-4946 (TOLL-FREE)

Email: techsupport@VIZIO.com

Web: www.VIZIO.com/support

Hours of operation:

Monday - Friday: 5 AM TO 9 PM (PST)

Saturday - Sunday: 8 AM TO 4 PM (PST)

We speak English • Se habla Español • Nous parlons Français

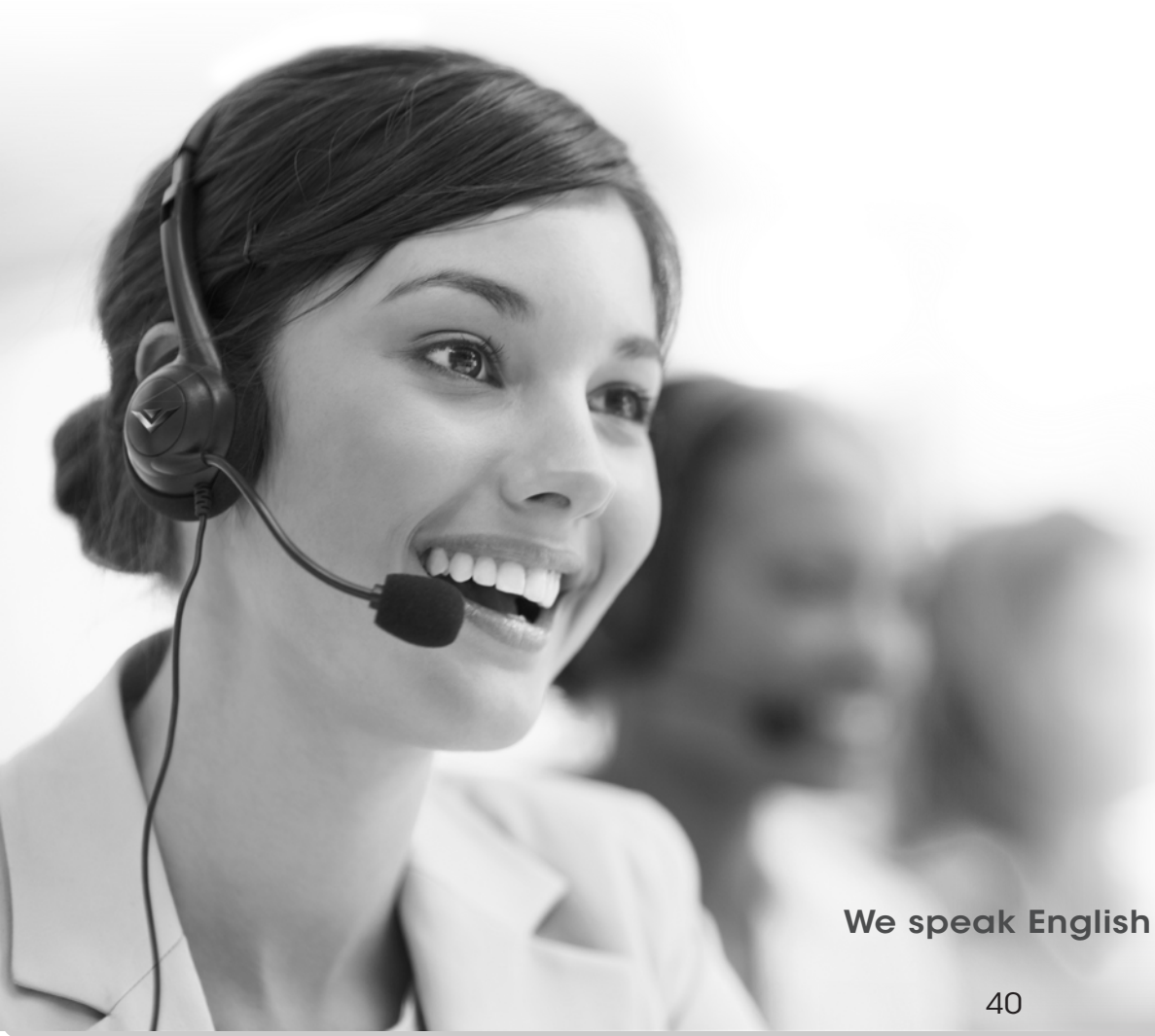

The TV displays “No Signal.”

- Press the INPUT button on the remote control to select a different input source.
- If you are using cable TV, satellite, or antenna connected directly to the TV, scan for channels. See *Scanning for Channels on page 27*.

There is no power.

- Ensure the TV is plugged into a working electrical outlet.
- Ensure the power cable is securely attached to the TV.
- Press the **Power/Standby** button on the remote or on the side of the TV to turn the TV on.

The power is on, but there is no image on the screen.

- Ensure all cables are securely attached to the TV.
- Ensure all devices are connected correctly. Devices differ; see your device’s user manual for details.
- Adjust Brightness, Contrast, or Backlight. See *Adjusting the Picture Settings on page 21*.
- Press the INPUT button on the remote to select a different input source.

There is no sound.

- Press Volume Up on the remote control.
- Press the **MUTE** button on the remote to ensure mute is off.
- Check the audio settings. See *Adjusting the Audio Settings on page 24*.
- Ensure the speakers are set to On.
- Ensure no headphones are connected to the TV.
- Check the audio connections of external devices (Blu-ray player, game console, cable/satellite box) that are connected to the TV.
- If you are using an antenna, the signal strength of the channel may be low. Ensure your antenna is connected securely to the TV and move the antenna around the room or close to a window for the best signal.

The colors on the TV don’t look right.

- Adjust the Color and Tint settings in the Picture menu. See *Adjusting the Picture Settings on page 21*.
- Reset the picture settings. See *Resetting the Picture Settings on page 24*.
- Check all cables to ensure they are securely attached.

The buttons on the remote aren’t working.

- Ensure you are only pressing one button at a time.
- Point the remote directly at the TV when pressing a button.
- Replace the remote batteries with new ones. See *Replacing the Batteries on page 10*.

The image quality is not good.

- For the best image quality, view high-definition programs using digital sources. Connect your devices with HDMI cables.
- If you are using an antenna, the signal strength of the channel may be low. Ensure your antenna is connected securely to the TV and move the antenna around the room or close to a window for the best signal.

The picture is distorted.

- Nearby electrical devices may be interfering with the TV. Separate the TV from electrical appliances, cars, or fluorescent lights.
- Ensure all cables are securely attached.

The display image does not cover the entire screen.

- If you are in RGB mode (computer), ensure that H-Size and V-Position in the on-screen menu are set correctly.
- If you are using TV, AV1, AV2, or Component with 480i input, press the WIDE button on the remote to change the screen mode.

The TV has pixels (dots) that are always dark or always lit.

- Your HDTV is precision-manufactured using an extremely high level of technology. However, sometimes pixels may not display correctly. These types of occurrences are inherent to this type of product and do not constitute a defective product.

I see “noise” or static on the screen.

- When your TV’s digital capabilities exceed a digital broadcast signal, the signal is up-converted (improved) to match your TV’s display capabilities. This up-converting can sometimes cause irregularities in the image.
- If you are using an antenna, the signal strength of the channel may be low. Ensure your antenna is connected securely to the TV and move the antenna around the room or close to a window for the best signal.

When I change input source, the volume changes.

- The TV remembers the volume level on each input source. If the volume level on the new input source is higher or lower than the level on the source you switch from, the difference may be noticeable.
- Use the Volume Up/Down buttons on the remote to adjust the volume.

When I change input source, the display image changes size.

- The TV remembers the viewing mode on each input source. If the viewing mode on the new input source differs from the one on the input source you switch from, the difference may be noticeable.
- See *Changing the Screen Aspect Ratio* on page 18.

	E241-A1	E291-A1
Screen Size:	24" Class	29" Class
Viewable Area:	23.54"	29.00"
Dimensions w/ Stand:	22.08" x 14.31" x 6.20"	26.42" x 16.75" x 8.12"
w/o Stand:	22.08" x 14.31" x 1.57"	26.42" x 16.75" x 1.97"
Weight w/ Stand:	8.60 lbs	14.33 lbs
w/o Stand:	8.05 lbs	13.23 lbs
TV Type:	LED	LED
Refresh Rate:	60 Hz	60 Hz
Maximum Resolution:	1920 x 1080	1366 x 768
Pixel Pitch:	.271 mm x .271 mm	.462 mm x .462 mm
Response Time:	5 ms	8.5 ms
Brightness:	250 nits	300 nits
Viewing Angle:	178° (H) / 170° (V)	176° (H) / 176° (V)
HDMI Inputs:	1	2
Component Video Inputs:	1	1
Composite Inputs:	1 (Shared with Component)	1 (Shared with Component)
RF Antenna Input:	1	1
USB 2.0 Ports:	1	1
Audio Outputs:	RCA Analog Stereo Output	RCA Analog Stereo Output, Optical Digital

	E241-A1	E291-A1
OSD Language:	English, Spanish, French	English, Spanish, French
Remote Control Model:	XRT020	XRT020
Certifications:	CSA, CSA-US, FCC Class B, HDMI 1.4, Dolby digital Plus	CSA, CSA-US, FCC Class B, HDMI 1.4, Dolby digital Plus
Compliance:	Energy Star	Energy Star
Voltage Range:	120V @ 50/60 Hz	120V @ 50/60 Hz
Power Consumption:	27.5W	36.5W
Standby Power:	<1W	<1W
Zero Bright Pixel Guarantee:	Yes	Yes

ON PARTS AND LABOR

Covers units purchased as new in United States and Puerto Rico Only. VIZIO provides a warranty to the original purchaser of a new Product against defects in materials and workmanship for a period of one (1) year of non-commercial usage and ninety (90) days of commercial use. If a Product covered by this warranty is determined to be defective within the warranty period, VIZIO will either repair or replace the Product at its sole option and discretion.

To obtain warranty service, contact VIZIO Technical Support via e-mail: TechSupport@VIZIO.com or via phone at 877 MY VIZIO (877.698.4946) from 5:00AM to 9:00PM Monday through Friday and 8:00AM to 4:00PM Saturday and Sunday, Pacific Time, or visit www.VIZIO.com. PRE-AUTHORIZATION MUST BE OBTAINED BEFORE SENDING ANY PRODUCT TO A VIZIO SERVICE CENTER. Proof of purchase in the form of a purchase receipt or copy thereof is required to show that a Product is within the warranty period.

Parts and Labor

There will be no charge for parts or labor during the warranty period. Replacement parts and Products may be new or recertified at VIZIO's option and sole discretion. Replacement parts and Products are warranted for the remaining portion of the original warranty or for ninety (90) days from warranty service or replacement, whichever is greater.

Type of Service

Defective Products must be sent to a VIZIO service center to obtain warranty service. VIZIO is not responsible for transportation costs to the service center, but VIZIO will cover return shipping to the customer. PRE-AUTHORIZATION IS REQUIRED BEFORE SENDING ANY PRODUCT TO A VIZIO SERVICE CENTER FOR WARRANTY SERVICE.

Product returns to VIZIO's service centers must utilize either the original carton box and shipping material or packaging that affords an equal degree of protection. VIZIO Technical Support will provide instructions for packing and shipping the covered Product to the VIZIO service center.

Limitations and Exclusions

VIZIO's one-year limited warranty only covers defects in materials and workmanship. This warranty does not cover, for example: cosmetic damage, normal wear and tear, improper operation, improper voltage supply or power surges, signal issues, damages from shipping, acts of God, any type of customer misuse, modifications or adjustments, as well as installation and set-up issues or any repairs attempted by anyone

other than by a VIZIO authorized service center. Products with unreadable or removed serial numbers, or requiring routine maintenance are not covered. This one year limited warranty does not cover Products sold "AS IS", "FACTORY RECERTIFIED", or by a non-authorized reseller.

THERE ARE NO EXPRESS WARRANTIES OTHER THAN THOSE LISTED OR DESCRIBED ABOVE. ANY IMPLIED WARRANTIES, INCLUDING ANY IMPLIED WARRANTY OF MERCHANTABILITY AND FITNESS FOR A PARTICULAR PURPOSE, SHALL BE LIMITED IN DURATION TO THE PERIOD OF TIME SET FORTH ABOVE. VIZIO'S TOTAL LIABILITY FOR ANY AND ALL LOSSES AND DAMAGES RESULTING FROM ANY CAUSE WHATSOEVER INCLUDING VIZIO'S NEGLIGENCE, ALLEGED DAMAGE, OR DEFECTIVE GOODS, WHETHER SUCH DEFECTS ARE DISCOVERABLE OR LATENT, SHALL IN NO EVENT EXCEED THE PURCHASE PRICE OF THE PRODUCT. VIZIO SHALL NOT BE RESPONSIBLE FOR LOSS OF USE, LOSS OF INFORMATION OR DATA, COMMERCIAL LOSS, LOST REVENUE OR LOST PROFITS, OR OTHER INCIDENTAL OR CONSEQUENTIAL DAMAGES. SOME STATES DO NOT ALLOW LIMITATIONS ON HOW LONG AN IMPLIED WARRANTY LASTS OR THE EXCLUSION OF INCIDENTAL OR CONSEQUENTIAL DAMAGES, SO THE ABOVE LIMITATIONS OR EXCLUSIONS MAY NOT APPLY TO YOU. THIS WARRANTY GIVES YOU SPECIFIC LEGAL RIGHTS, AND YOU MAY ALSO HAVE OTHER RIGHTS, WHICH VARY FROM STATE TO STATE. THIS WARRANTY IS SUBJECT TO CHANGE WITHOUT NOTICE.

CHECK WWW.VIZIO.COM FOR THE MOST CURRENT VERSION.

Personal Data

If your VIZIO product is capable of storing personal data and other information, ALL CONTENTS AND INFORMATION WILL BE DELETED IN THE COURSE OF SOME IN-HOME AND ALL SHIP-IN WARRANTY SERVICE. If this occurs, your product will be restored to you configured as originally purchased. You will be responsible for restoring all applicable data and passwords. Recovery and reinstallation of user data is not covered under this Limited Warranty. In order to protect your personal information, VIZIO recommends that you always clear all personal information from the unit before it is serviced, regardless of the servicer.

Zero Bright Pixel Defect Guarantee

This policy covers "zero bright pixel" defects for the duration of the limited "ONE YEAR WARRANTY" on select new product purchases. To determine if this guarantee applies to your product, refer to the "DETAILS" tab of the model's product information page (www.VIZIO.com) or look for the "zero bright pixel" guarantee on the box.

FCC Class B Radio Interference Statement

NOTE: This equipment has been tested and found to comply with the limits for a Class B digital device, pursuant to Part 15 of the FCC Rules. These limits are designed to provide reasonable protection against harmful interference in a residential installation. This equipment generates, uses and can radiate radio frequency energy, and if not installed and used in accordance with the instructions, may cause harmful interference to radio communications. However, there is no guarantee that interference will not occur in a particular installation. If this equipment does cause harmful interference to radio or television reception, which can be determined by turning the equipment off and on, the user is encouraged to try to correct the interference by one or more of the following measures:

1. Reorient or relocate the receiving antenna.
2. Increase the separation between the equipment and receiver.
3. Connect the equipment into an outlet on a circuit different from that to which the receiver is connected.
4. Consult the dealer or an experienced radio/TV technician for help.

This device complies with Part 15 of the FCC Rules. Operation is subject to the following two conditions: (1) this device may not cause harmful interference, and (2) this device must accept any interference received, including interference that may cause undesired operation.

Notice

1. The changes or modifications not expressly approved by the party responsible for compliance could void the user's authority to operate the equipment.
2. Shielded interface cables and AC power cord, if any, must be used in order to comply with the emission limits.
3. The manufacturer is not responsible for any radio or TV interference caused by unauthorized modification to this equipment. It is the responsibilities of the user to correct such interference.

FCC warning

Changes or modifications not expressly approved by the party responsible for compliance with the FCC Rules could void the user's authority to operate this equipment.

Other

Image(s) used under license from Shutterstock.com

