

VIZIO



QUICK START GUIDE

Model: E241i-A1 & E291i-A1

IMPORTANT SAFETY INSTRUCTIONS

Your TV is designed and manufactured to operate within defined design limits. Misuse may result in electric shock or fire. To prevent your TV from being damaged, the following instructions should be observed for the installation, use, and maintenance of your TV. Read the following safety instructions before operating your TV. Keep these instructions in a safe place for future reference.

To reduce the risk of electric shock or component damage, switch off the power before connecting other components to your TV.

- Read these instructions.
- Keep these instructions.
- Heed all warnings.
- Follow all instructions.
- Do not use this apparatus near water.
- Clean only with a dry cloth.
- Do not block any ventilation openings. Install in accordance with the manufacturer's instructions.
- Do not install near any heat sources such as radiators, heat registers, stoves, or other apparatus (including amplifiers) that produce heat.
- Do not defeat the safety purpose of the polarized or grounding-type plug. A polarized plug has two blades and a third grounding prong. The wide blade or the third prong are provided for your safety. If the provided plug does not fit into your outlet, consult an electrician for replacement of the obsolete outlet.
- Protect the power cord from being walked on or pinched, particularly at plugs, convenience receptacles, and the point where they exit from the apparatus.
- Only use attachments/accessories specified by the manufacturer.
- Use only with the cart, stand, tripod, bracket, or table specified by the manufacturer, or sold with the apparatus. When a cart is used, use caution when moving the cart/apparatus combination to avoid injury from tip-over.
- Unplug this apparatus during lightning storms or when unused for long periods of time.
- Refer all servicing to qualified service personnel. Servicing is required when the apparatus has been damaged in any way, such as when the power-supply cord or plug is damaged, liquid has been spilled or objects have fallen into the apparatus, the apparatus has been exposed to rain or moisture, does not operate normally or has been dropped.
- Unplug the power cord before cleaning your TV.
- When moving your TV from an area of low temperature to an area of high temperature, condensation may form in the housing. Wait before turning on your TV to avoid causing fire, electric shock, or component damage.
- A distance of at least three feet should be maintained between your TV and any heat source, such as a radiator, heater, oven, amplifier etc. Do not install your TV close to smoke. Operating your TV close to smoke or moisture may cause fire or electric shock.
- Slots and openings in the back and bottom of the cabinet are provided for ventilation. To ensure reliable operation of your TV and to protect it from overheating, be sure these openings are not blocked or covered. Do not place your TV in a bookcase or cabinet unless proper ventilation is provided.
- Never push any object into the slots and openings on your TV cabinet. Do not place any objects on the top of your TV. Doing so could short circuit parts causing a fire or electric shock. Never spill liquids on your TV.
- Your TV should be operated only from the type of power source indicated on the label. If you are not sure of the type of power supplied to your home, consult your dealer or local power company.
- Do not apply pressure or throw objects at your TV. This may compromise the integrity of the display. The manufacturer's warranty does not cover user abuse or improper installations.
- The power cord must be replaced when using different voltage than the voltage specified. For more information, contact your dealer.
- Your TV is equipped with a three-pronged grounded plug (a plug with a third grounding pin). This plug will fit only into a grounded power outlet. This is a safety feature. If your outlet does not accommodate the three-pronged, have an electrician install the correct outlet, or use an adapter to ground your TV safely. Do not defeat the safety purpose of the grounded plug.
- When connected to a power outlet, power is always flowing into your TV. To totally disconnect power, unplug the power cord.



- The lightning flash with arrowhead symbol within an equilateral triangle is intended to alert the user to the presence of unisolated, dangerous voltage within the inside of your TV that may be of sufficient magnitude to constitute a risk of electric shock to persons.
- Do not overload power strips and extension cords. Overloading can result in fire or electric shock.
- The wall socket should be installed near your TV and easily accessible.
- Only power of the marked voltage can be used for your TV. Any other voltage than the specified voltage may cause fire or electric shock.
- Do not touch the power cord during lightning. To avoid electric shock, avoid handling the power cord during electrical storms.
- Unplug your TV during a lightning storm or when it will not be used for long period of time. This will protect your TV from damage due to power surges.
- Do not attempt to repair or service your TV yourself. Opening or removing the back cover may expose you to high voltages, electric shock, and other hazards. If repair is required, contact your dealer and refer all servicing to qualified service personnel.
- **WARNING:** Keep your TV away from moisture. Do not expose your TV to rain or moisture. If water penetrates into your TV, unplug the power cord and contact your dealer. Continuous use in this case may result in fire or electric shock.
- Do not use your TV if any abnormality occurs. If any smoke or odor becomes apparent, unplug the power cord and contact your dealer immediately. Do not try to repair your TV yourself.
- Avoid using dropped or damaged appliances. If your TV is dropped and the housing is damaged, the internal components may function abnormally. Unplug the power cord immediately and contact your dealer for repair. Continued use of your TV may cause fire or electric shock.
- Do not install your TV in an area with heavy dust or high humidity. Operating your TV in environments with heavy dust or high humidity may cause fire or electric shock.
- Follow instructions for moving your TV. Ensure that the power cord and any other cables are unplugged before moving your TV.
- When unplugging your TV, hold the AC/DC power adapter, not the cord. Pulling on the power cord may damage the wires inside the cord and cause fire or electric shock. When your TV will not be used for an extended period of time, unplug the power cord.
- To reduce risk of electric shock, do not touch the connector with wet hands.
- Insert batteries in accordance with instructions. Incorrect polarities may cause the batteries to leak which can damage the remote control or injure the operator. Do not expose batteries to excessive heat such as sunshine, fire or the like.
- If any of the following occurs, contact the dealer:
 - The power cord fails or frays.
 - Liquid sprays or any object drops into your TV.
 - Your TV is exposed to rain or other moisture.
 - Your TV is dropped or damaged in any way.
 - The performance of your TV changes substantially.
- This apparatus shall not be exposed to dripping or splashing and no objects filled with liquids, such as vases, shall be placed on the apparatus.
- The mains plug or appliance coupler is used as the disconnect device, the disconnect device shall remain readily operable.
- **CAUTION** - These servicing instructions are for use by qualified service personnel only. To reduce the risk of electric shock, do not perform any servicing other than that contained in the operating instructions unless you are qualified to do so.



The lightning flash with arrowhead symbol within an equilateral triangle is intended to alert the user to the presence of unisolated DANGEROUS VOLTAGE within the product's enclosure that may be of sufficient magnitude to constitute a risk of electrical shock to persons.



The exclamation point within an equilateral triangle is intended to alert the user to the presence of important operating and maintenance (servicing) instructions in the literature accompanying the product.

DO YOU HAVE QUESTIONS?

LET US HELP!

YOUR PRODUCT INCLUDES FREE LIFETIME TECH SUPPORT



The VIZIO support team is highly trained and is based in the United States.

We can help with:

- New Product Setup
- Connecting Your Devices
- Technical Problems
- And More

Phone: (877) 878-4946 (TOLL-FREE)

Email: techsupport@VIZIO.com

Web: <http://store.VIZIO.com/support>

Hours of operation:

Monday - Friday: 5 AM TO 9 PM (PST)

Saturday - Sunday: 8 AM TO 4 PM (PST)

We speak English • Se habla Español • Nous parlons Français

PACKAGE CONTENTS

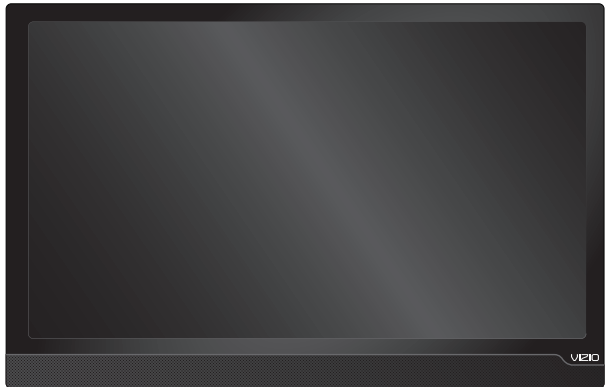

VIZIO LED HDTV with Stand



Remote Control and Batteries



This Quick Start Guide



Power Cord

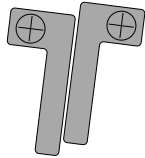

2 x Rubber Feet



2 x Phillips Screws

INSTALLING THE BASE

1

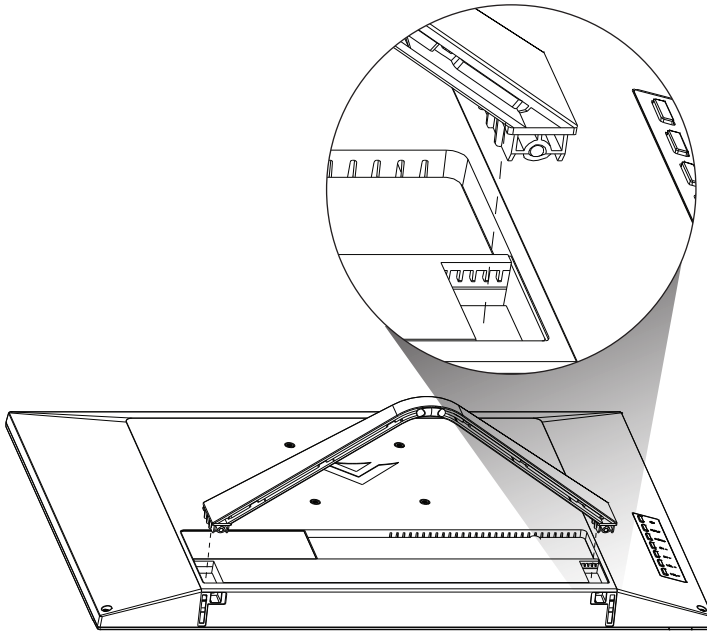

Place the TV screen-down on a clean, flat surface. To prevent scratches or damage to the screen, place the TV on a soft surface, such as a blanket.

Gently push the base into the slots as shown.

2

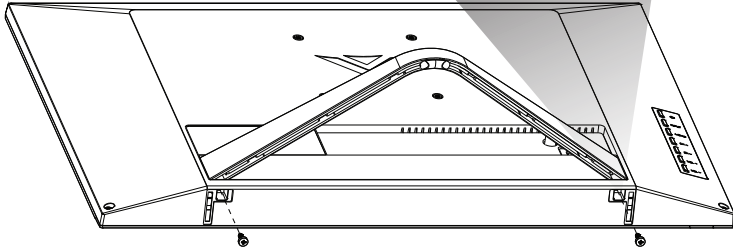
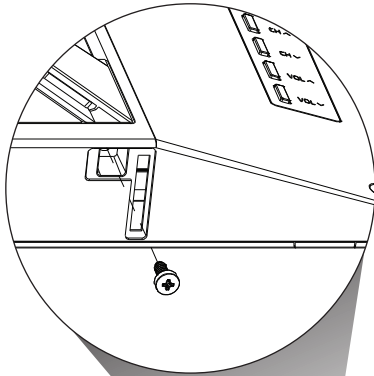

Insert and tighten the two(2) included Phillips screws into the base with a Phillips screwdriver.*

3

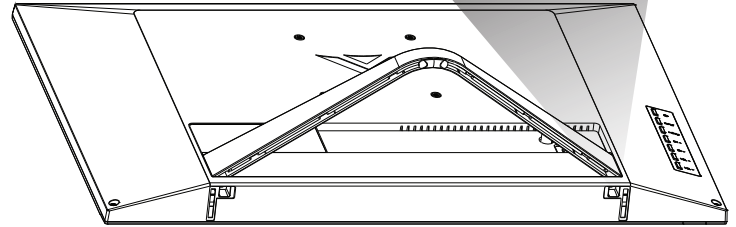
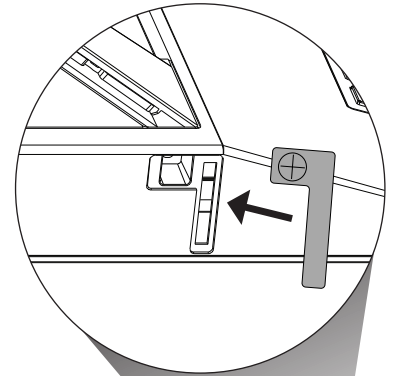

Insert the two(2) included rubber feet over the screws as shown and press firmly to secure them.

When you are finished, place the TV on a stable, level surface.

* Not included

USING THE REMOTE

APP LAUNCHER

Quickly launch the pictured app.

INPUT

Change the currently-displayed input.

A/V CONTROLS

Control USB media player.

CLOSED CAPTIONS

Open the closed caption menu.

EXIT

Close the on-screen menu.

OK

Select the highlighted menu option.

BACK

Go to the previous on-screen menu.

VOLUME UP/DOWN

Increase or decrease loudness of the audio.

MUTE

Turn the audio off or on.

NUMBER PAD

Manually enter a channel.

WIDE

Switch the display mode.

POWER

Turn TV on or off.

INFO

Display the info window.

MENU

Display the on-screen menu.

ARROW

Navigate the on-screen menu.

GUIDE

Display the info window.

V BUTTON

Open the VIA dock.

CHANNEL UP/DOWN

Change the channel.

LAST

Return to the channel last viewed.

DASH

Use with number pad to manually enter a digital sub-channel. (For example, 18-4 or 18-5.)

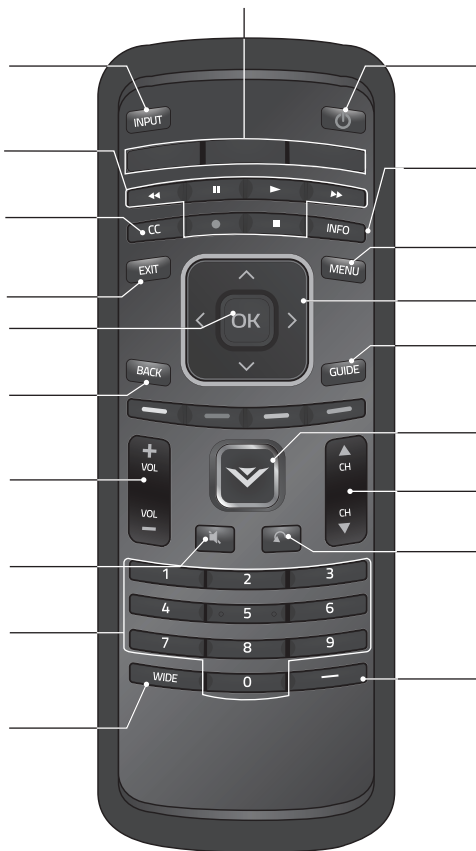

FIRST-TIME SETUP

1

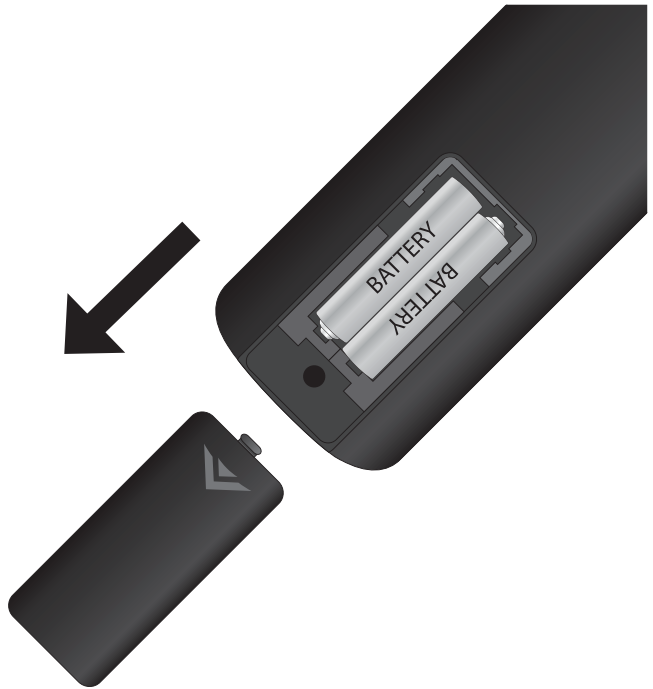

Remove the battery cover by pressing gently on the arrow and sliding away from the remote.

Insert the included batteries.

Gently slide the battery cover back into place.

2

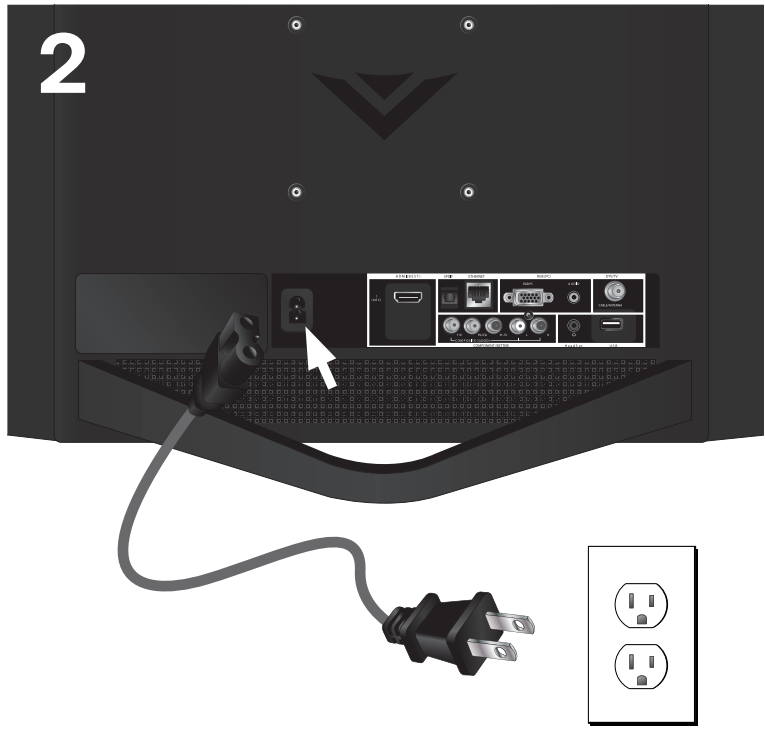

Connect the power cord to the back of the TV.

Note: The image shown above is for illustrative purposes only and may be subject to change. The actual number of ports and their locations may vary, depending on the model.

3

Back of TV

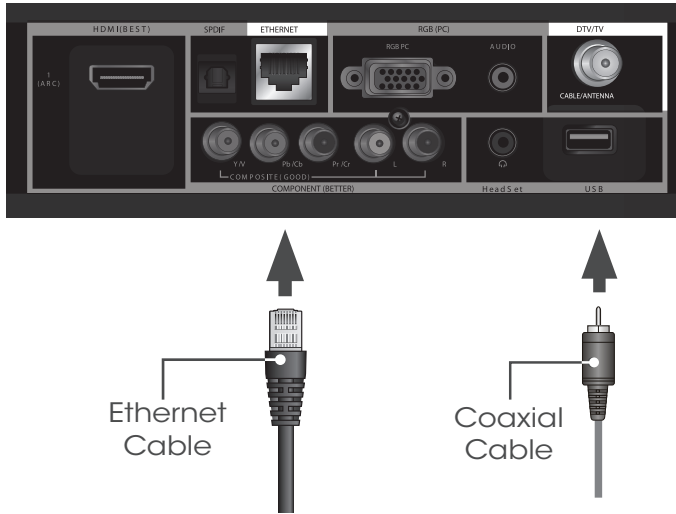

If you have an external antenna or a cable connection that extends from a wall outlet, connect it to the TV with an RF/Coaxial cable.

If you have a high-speed internet connection, connect an Ethernet cable from your modem or router to the back of the TV as shown.

Note: The image shown above is for illustrative purposes only and may be subject to change. The actual number of ports and their locations may vary, depending on the model.

4



Turn the TV on by pressing the **Power** button on the remote.

The **Setup App** is displayed.

Use the Arrow buttons on the remote to highlight Home Mode Setup and press **OK**.

VIEWING THE ON-SCREEN USER MANUAL

1



V Button

Press the **V Button** on the Remote Control to display the V.I.A. Dock.

2



Select **HDTV Settings**.

3

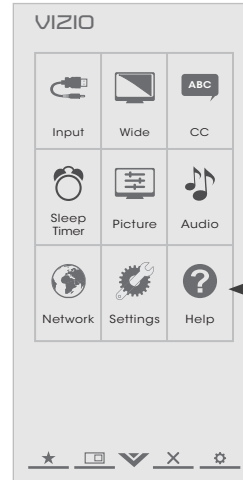

Highlight **Help** and press **OK**.

4



Select **User Manual** and press **OK** to view the on-screen User Manual.

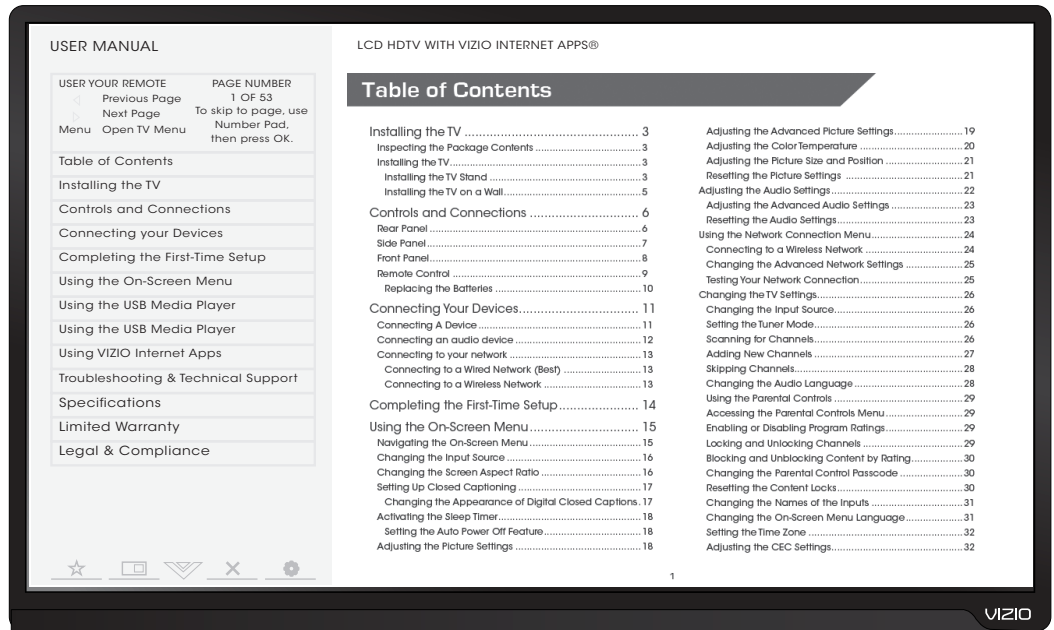

Press the **EXIT** button to exit the on-screen User Manual.

Use the **Up** and **Down** Arrow buttons to select the chapter you want to view.

Use the **Left** and **Right** Arrow buttons to browse through the pages in each chapter.

CONNECTING YOUR DEVICES

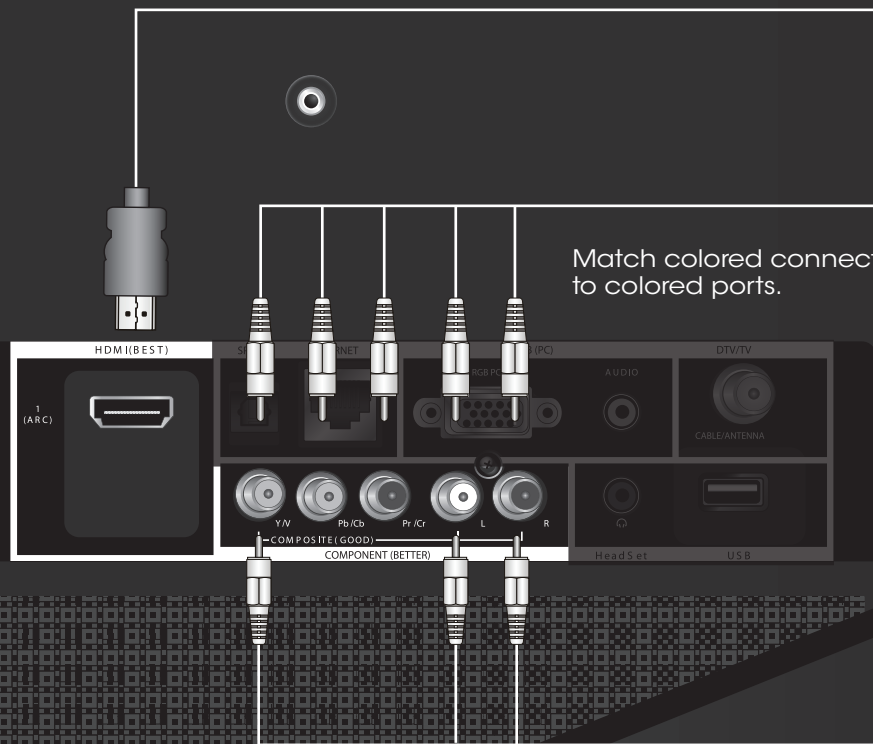

Match colored connectors to colored ports.

BACK OF TV

Note: The image shown above is for illustrative purposes only and may be subject to change. The actual number of ports and their locations may vary, depending on the model.

Choose **ONE** connection type for each device.
(Cables are not included.)

HDMI CABLE

BEST

- DIGITAL
- HD VIDEO (1080P)*
- HD AUDIO



COMPONENT CABLE

BETTER

- ANALOG
- HD VIDEO (1080P)*
- STEREO AUDIO

Match colored connectors
to colored ports.

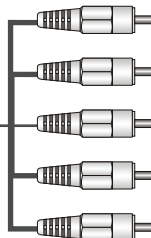

AV CABLE

GOOD

- ANALOG
- VIDEO (480i)*
- STEREO AUDIO

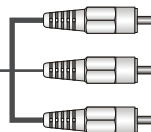

* Maximum Resolution

Commonly-Connected
Devices:



Cable or Satellite Boxes



Blu-ray™ or DVD Players



Game Consoles

GETTING STARTED WITH VIZIO INTERNET APPS

1



V.I.A.
Press this button to
open the V.I.A. Dock.

Be sure your TV is connected to the Internet.
Use an Ethernet cable or connect wirelessly.
For the best V.I.A. experience, a high-speed
Internet connection is recommended.

2

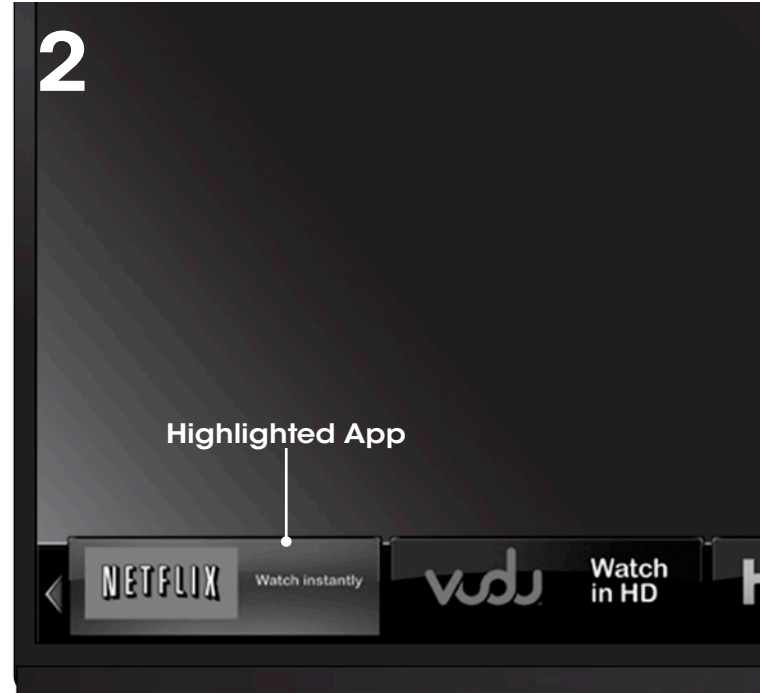

Highlighted App

The V.I.A. Dock is displayed on the bottom of
the screen.

Use the **Arrow** buttons on the remote to
highlight an app, then press **OK** to open it.

3

Your V.I.A Dock has many popular apps pre-loaded, but you can add more at any time. To discover and add new apps to the Dock, open the **Yahoo! Connected TV Store App**.

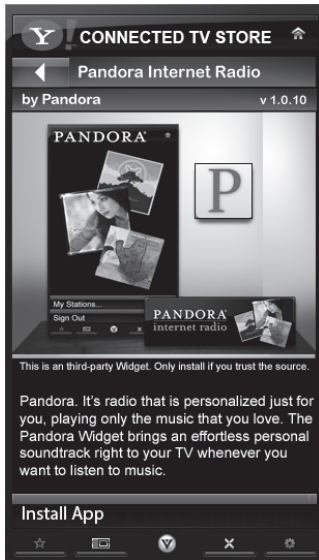

Highlight **Categories** and press **OK**.

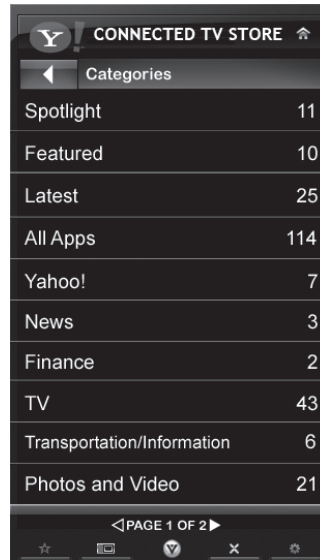

A list of app categories is displayed. Select a category and browse through the available apps.



When you've found an app you want to add to the Dock, highlight **Install App** and press **OK**.

VIZIO RECOMMENDS

THE ULTIMATE ULTRABOOK™



14" THIN+LIGHT

With uncompromising performance, and premium picture and audio quality in a remarkably thin profile, the VIZIO Thin+Light is the Ultrabook that's impossible to ignore. Ultra-responsive and ultra-portable, the VIZIO Thin+Light boots up instantly and goes wherever you do. If good things come in small packages, this must be the best there is.

Available at www.VIZIO.com

This Product Sold Separately

HELP TOPICS

How do I return to the Setup App?

- The on-screen menu has guided setup. Press MENU, then select HELP > Guided Setup. Select the type of setup you need and press OK. The Setup App will begin.
 - To reset the TV to factory defaults, press MENU > HELP > Reset TV Settings. Select Yes. Remember that all of your settings will be lost!
-

There is a picture, but there is no sound.

- Press the VOLUME UP button on the remote or on the side of the TV.
 - Press the MUTE button on the remote to ensure that mute is off.
 - Press MENU, then select TV Settings > Audio. Be sure TV Speakers is set to ON.
-

The TV displays "No Signal."

- Be sure your connected devices are turned on.
 - Press the INPUT button on the remote and select the input to which your device is connected (HDMI-1, Composite, Component, etc).
-

There are black/gray bars on the top/bottom/sides of the screen.

- Note that some television channels add black bars to the picture.
 - Set the TV to Wide or Zoom mode. Press MENU, then select Wide. Highlight Wide or Zoom and press OK.
 - Adjust the video settings of your external device
-

There is no power.

- Be sure the power cord is securely connected to the AC socket on the TV and to a working electrical outlet.
 - Press the POWER button on the remote or on the side of the TV.
 - If the above steps do not work, try plugging the power cord into a different outlet.
-

The V.I.A. App is not working.

- Be sure your TV is connected to an Internet connection.
- Restart the App by pressing the EXIT button to close the App, then open the App.
- Reboot your TV by pressing the POWER button on the remote, then turn it back on.

LEGAL / COMPLIANCE

FCC Class B Radio Interference Statement

NOTE: This equipment has been tested and found to comply with the limits for a Class B digital device, pursuant to Part 15 of the FCC Rules. These limits are designed to provide reasonable protection against harmful interference in a residential installation. This equipment generates, uses and can radiate radio frequency energy, and if not installed and used in accordance with the instructions, may cause harmful interference to radio communications. However, there is no guarantee that interference will not occur in a particular installation. If this equipment does cause harmful interference to radio or television reception, which can be determined by turning the equipment off and on, the user is encouraged to try to correct the interference by one or more of the following measures:

- Reorient or relocate the receiving antenna.
- Increase the separation between the equipment and receiver.
- Connect the equipment into an outlet on a circuit different from that to which the receiver is connected.
- Consult the dealer or an experienced radio/TV technician for help.

This device complies with Part 15 of the FCC Rules. Operation is subject to the following two conditions: (1) this device may not cause harmful interference, and (2) this device must accept any interference received, including interference that may cause undesired operation.

Notice

The changes or modifications not expressly approved by the party responsible for compliance could void the user's authority to operate the equipment.

Shielded interface cables and AC power cord, if any, must be used in order to comply with the emission limits.

The manufacturer is not responsible for any radio or TV interference caused by unauthorized modification to this equipment. It is the responsibilities of the user to correct such interference.

FCC warning

Changes or modifications not expressly approved by the party responsible for compliance with the FCC Rules could void the user's authority to operate this equipment.

Caution

Always use an AC/DC power adapter that is properly grounded. Use the AC cords listed below for each area.

USA: UL Germany: VDE Japan: Electric Appliance Control Act
Canada: CSA UK: BASE/BS

Other

Image(s) used under license from Shutterstock.com

VIZIO, Inc. has made every effort to ensure the accuracy of the information provided herein. All product specifications, functionality, features, configurations, performance, design and other product information described herein are subject to change without notice. VIZIO, Inc. disclaims liability for typographical, technical, or descriptive errors

LIMITED WARRANTY

ON PARTS AND LABOR

Covers units purchased as new in United States and Puerto Rico Only.

VIZIO provides a warranty to the original purchaser of a new Product against defects in materials and workmanship for a period of one (1) year of non-commercial usage and ninety (90) days of commercial use. If a Product covered by this warranty is determined to be defective within the warranty period, VIZIO will either repair or replace the Product at its sole option and discretion.

To obtain warranty service, contact VIZIO Technical Support via e-mail: TechSupport@VIZIO.com or via phone at 877 MY VIZIO (877.698.4946) from 5:00AM to 9:00PM Monday through Friday and 8:00AM to 4:00PM Saturday and Sunday, Pacific Time, or visit www.VIZIO.com. PRE-AUTHORIZATION MUST BE OBTAINED BEFORE SENDING ANY PRODUCT TO A VIZIO SERVICE CENTER. Proof of purchase in the form of a purchase receipt or copy thereof is required to show that a Product is within the warranty period.

Parts and Labor

There will be no charge for parts or labor during the warranty period. Replacement parts and Products may be new or recertified at VIZIO's option and sole discretion. Replacement parts and Products are warranted for the remaining portion of the original warranty or for ninety (90) days from warranty service or replacement, whichever is greater.

Type of Service

Defective Products must be sent to a VIZIO service center to obtain warranty service. VIZIO is not responsible for transportation costs to the service center, but VIZIO will cover return shipping to the customer. PRE-AUTHORIZATION IS REQUIRED BEFORE SENDING ANY PRODUCT TO A VIZIO SERVICE CENTER FOR WARRANTY SERVICE.

Product returns to VIZIO's service centers must utilize either the original carton box and shipping material or packaging that affords an equal degree of protection. VIZIO Technical Support will provide instructions for packing and shipping the covered Product to the VIZIO service center.

Limitations and Exclusions

VIZIO's one-year limited warranty only covers defects in materials and workmanship. This warranty does not cover, for example: cosmetic damage, normal wear and tear, improper operation, improper voltage supply or power surges, signal issues, damages from shipping, acts of God, any type of customer misuse, modifications or adjustments, as well as installation and set-up issues or any repairs attempted by anyone other than by a VIZIO authorized service

center. Products with unreadable or removed serial numbers, or requiring routine maintenance are not covered. This one year limited warranty does not cover Products sold "AS IS", "FACTORY RECERTIFIED", or by a non-authorized reseller.

THERE ARE NO EXPRESS WARRANTIES OTHER THAN THOSE LISTED OR DESCRIBED ABOVE. ANY IMPLIED WARRANTIES, INCLUDING ANY IMPLIED WARRANTY OF MERCHANTABILITY AND FITNESS FOR A PARTICULAR PURPOSE, SHALL BE LIMITED IN DURATION TO THE PERIOD OF TIME SET FORTH ABOVE. VIZIO'S TOTAL LIABILITY FOR ANY AND ALL LOSSES AND DAMAGES RESULTING FROM ANY CAUSE WHATSOEVER INCLUDING VIZIO'S NEGLIGENCE, ALLEGED DAMAGE, OR DEFECTIVE GOODS, WHETHER SUCH DEFECTS ARE DISCOVERABLE OR LATENT, SHALL IN NO EVENT EXCEED THE PURCHASE PRICE OF THE PRODUCT. VIZIO SHALL NOT BE RESPONSIBLE FOR LOSS OF USE, LOSS OF INFORMATION OR DATA, COMMERCIAL LOSS, LOST REVENUE OR LOST PROFITS, OR OTHER INCIDENTAL OR CONSEQUENTIAL DAMAGES. SOME STATES DO NOT ALLOW LIMITATIONS ON HOW LONG AN IMPLIED WARRANTY LASTS OR THE EXCLUSION OF INCIDENTAL OR CONSEQUENTIAL DAMAGES, SO THE ABOVE LIMITATIONS OR EXCLUSIONS MAY NOT APPLY TO YOU. THIS WARRANTY GIVES YOU SPECIFIC LEGAL RIGHTS, AND YOU MAY ALSO HAVE OTHER RIGHTS, WHICH VARY FROM STATE TO STATE. THIS WARRANTY IS SUBJECT TO CHANGE WITHOUT NOTICE.

CHECK WWW.VIZIO.COM FOR THE MOST CURRENT VERSION.

Personal Data

If your VIZIO product is capable of storing personal data and other information, ALL CONTENTS AND INFORMATION WILL BE DELETED IN THE COURSE OF SOME IN-HOME AND ALL SHIP-IN WARRANTY SERVICE. If this occurs, your product will be restored to you configured as originally purchased. You will be responsible for restoring all applicable data and passwords. Recovery and reinstallation of user data is not covered under this Limited Warranty. In order to protect your personal information, VIZIO recommends that you always clear all personal information from the unit before it is serviced, regardless of the servicer.

Zero Bright Pixel Defect Guarantee

This policy covers "zero bright pixel" defects for the duration of the limited "ONE YEAR WARRANTY" on select new product purchases. To determine if this guarantee applies to your product, refer to the "DETAILS" tab of the model's product information page (www.VIZIO.com) or look for the "zero bright pixel" guarantee on the box.

