

# VIZIO



## QUICK START GUIDE

Model: E500i-A1

# IMPORTANT SAFETY INSTRUCTIONS

Your TV is designed and manufactured to operate within defined design limits. Misuse may result in electric shock or fire. To prevent your TV from being damaged, the following instructions should be observed for the installation, use, and maintenance of your TV. Read the following safety instructions before operating your TV. Keep these instructions in a safe place for future reference.

To reduce the risk of electric shock or component damage, switch off the power before connecting other components to your TV.

- Read these instructions.
- Keep these instructions.
- Heed all warnings.
- Follow all instructions.
- Do not use this apparatus near water.
- Clean only with a dry cloth.
- Do not block any ventilation openings. Install in accordance with the manufacturer's instructions.
- Do not install near any heat sources such as radiators, heat registers, stoves, or other apparatus (including amplifiers) that produce heat.
- Do not defeat the safety purpose of the polarized or grounding-type plug. A polarized plug has two blades and a third grounding prong. The wide blade or the third prong are provided for your safety. If the provided plug does not fit into your outlet, consult an electrician for replacement of the obsolete outlet.
- Protect the power cord from being walked on or pinched, particularly at plugs, convenience receptacles, and the point where they exit from the apparatus.
- Only use attachments/accessories specified by the manufacturer.
- Use only with the cart, stand, tripod, bracket, or table specified by the manufacturer, or sold with the apparatus. When a cart is used, use caution when moving the cart/apparatus combination to avoid injury from tip-over.
- Unplug this apparatus during lightning storms or when unused for long periods of time.
- Refer all servicing to qualified service personnel. Servicing is required when the apparatus has been damaged in any way, such as when the power-supply cord or plug is damaged, liquid has been spilled or objects have fallen into the apparatus, the apparatus has been exposed to rain or moisture, does not operate normally or has been dropped.
- Unplug the power cord before cleaning your TV.
- When moving your TV from an area of low temperature to an area of high temperature, condensation may form in the housing. Wait before turning on your TV to avoid causing fire, electric shock, or component damage.
- A distance of at least three feet should be maintained between your TV and any heat source, such as a radiator, heater, oven, amplifier etc. Do not install your TV close to smoke. Operating your TV close to smoke or moisture may cause fire or electric shock.
- Slots and openings in the back and bottom of the cabinet are provided for ventilation. To ensure reliable operation of your TV and to protect it from overheating, be sure these openings are not blocked or covered. Do not place your TV in a bookcase or cabinet unless proper ventilation is provided.
- Never push any object into the slots and openings on your TV cabinet. Do not place any objects on the top of your TV. Doing so could short circuit parts causing a fire or electric shock. Never spill liquids on your TV.
- Your TV should be operated only from the type of power source indicated on the label. If you are not sure of the type of power supplied to your home, consult your dealer or local power company.
- Do not apply pressure or throw objects at your TV. This may compromise the integrity of the display. The manufacturer's warranty does not cover user abuse or improper installations.
- The power cord must be replaced when using different voltage than the voltage specified. For more information, contact your dealer.
- Your TV is equipped with a polarized plug. A polarized plug has two blades with one wider than the other. This plug will fit only into a polarized power outlet. This is a safety feature. Do not defeat the safety purpose of the polarized plug. If your outlet does not accommodate the polarized plug, have an electrician install the correct outlet.
- When connected to a power outlet, power is always flowing into your TV. To totally disconnect power, unplug the power cord.



- The lightning flash with arrowhead symbol within an equilateral triangle is intended to alert the user to the presence of unisolated, dangerous voltage within the inside of your TV that may be of sufficient magnitude to constitute a risk of electric shock to persons.
- Do not overload power strips and extension cords. Overloading can result in fire or electric shock.
- The wall socket should be installed near your TV and easily accessible.
- Only power of the marked voltage can be used for your TV. Any other voltage than the specified voltage may cause fire or electric shock.
- Do not touch the power cord during lightning. To avoid electric shock, avoid handling the power cord during electrical storms.
- Unplug your TV during a lightning storm or when it will not be used for long period of time. This will protect your TV from damage due to power surges.
- Do not attempt to repair or service your TV yourself. Opening or removing the back cover may expose you to high voltages, electric shock, and other hazards. If repair is required, contact your dealer and refer all servicing to qualified service personnel.
- **WARNING:** Keep your TV away from moisture. Do not expose your TV to rain or moisture. If water penetrates into your TV, unplug the power cord and contact your dealer. Continuous use in this case may result in fire or electric shock.
- Do not use your TV if any abnormality occurs. If any smoke or odor becomes apparent, unplug the power cord and contact your dealer immediately. Do not try to repair your TV yourself.
- Avoid using dropped or damaged appliances. If your TV is dropped and the housing is damaged, the internal components may function abnormally. Unplug the power cord immediately and contact your dealer for repair. Continued use of your TV may cause fire or electric shock.
- Do not install your TV in an area with heavy dust or high humidity. Operating your TV in environments with heavy dust or high humidity may cause fire or electric shock.
- Follow instructions for moving your TV. Ensure that the power cord and any other cables are unplugged before moving your TV.
- When unplugging your TV, hold the AC/DC power adapter, not the cord. Pulling on the power cord may damage the wires inside the cord and cause fire or electric shock. When your TV will not be used for an extended period of time, unplug the power cord.
- To reduce risk of electric shock, do not touch the connector with wet hands.
- Insert batteries in accordance with instructions. Incorrect polarities may cause the batteries to leak which can damage the remote control or injure the operator. Do not expose batteries to excessive heat such as sunshine, fire or the like.
- If any of the following occurs, contact the dealer:
  - The power cord fails or frays.
  - Liquid sprays or any object drops into your TV.
  - Your TV is exposed to rain or other moisture.
  - Your TV is dropped or damaged in any way.
  - The performance of your TV changes substantially.
- This apparatus shall not be exposed to dripping or splashing and no objects filled with liquids, such as vases, shall be placed on the apparatus.
- The mains plug or appliance coupler is used as the disconnect device, the disconnect device shall remain readily operable.
- **CAUTION** - These servicing instructions are for use by qualified service personnel only. To reduce the risk of electric shock, do not perform any servicing other than that contained in the operating instructions unless you are qualified to do so.



The lightning flash with arrowhead symbol within an equilateral triangle is intended to alert the user to the presence of unisolated DANGEROUS VOLTAGE within the product's enclosure that may be of sufficient magnitude to constitute a risk of electrical shock to persons.



The exclamation point within an equilateral triangle is intended to alert the user to the presence of important operating and maintenance (servicing) instructions in the literature accompanying the product.

DO YOU HAVE QUESTIONS?

# LET US HELP!

YOUR PRODUCT INCLUDES FREE LIFETIME TECH SUPPORT



The VIZIO support team is highly trained and is based in the United States.

We can help with:

- New Product Setup
- Connecting Your Devices
- Technical Problems
- And More

Phone: (877) 878-4946 (TOLL-FREE)

Email: [techsupport@VIZIO.com](mailto:techsupport@VIZIO.com)

Web: <http://store.VIZIO.com/support>

Hours of operation:

Monday - Friday: 5 AM TO 8 PM (PST)

Saturday - Sunday: 7 AM TO 4 PM (PST)

We speak English • Se habla Español • Nous parlons Français

# PACKAGE CONTENTS



VIZIO LED HDTV with Stand



Remote Control with Batteries



This Quick Start Guide



Power Cord



3 x M6 12mm Phillips Screws



4 x M4 16mm Phillips Screws

# USING THE REMOTE



# INSTALLING THE BASE

## 1

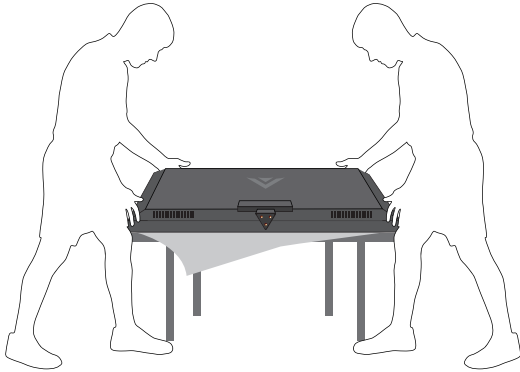

It is recommended that two people take part in the base installation.

Place the TV screen-down on a clean, flat surface. To prevent scratches or damage to the screen, place the TV on a soft surface, such as a blanket.

## 2

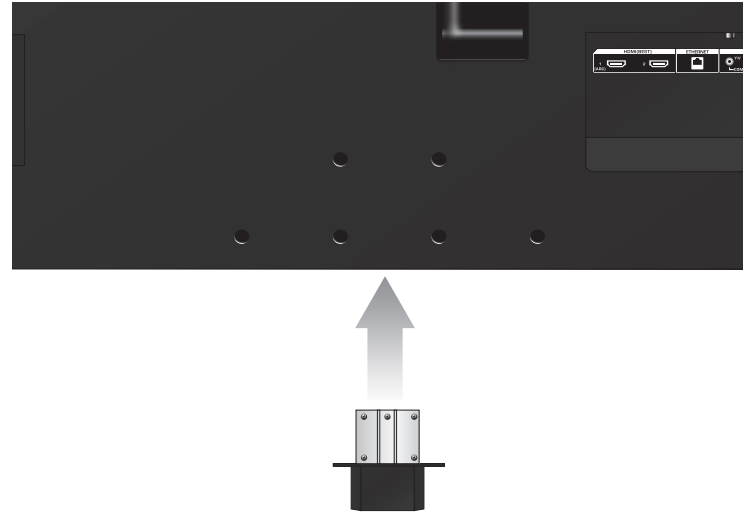

Align the neck piece with the bottom of the TV and slide it into place as shown above.

# 3

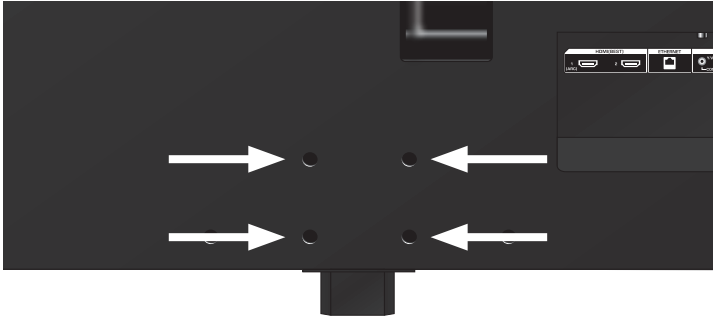

Using a Phillips screwdriver, tighten four (4) M4 16mm Phillips screws into the holes on the back of the TV to secure the neck piece.

# 4

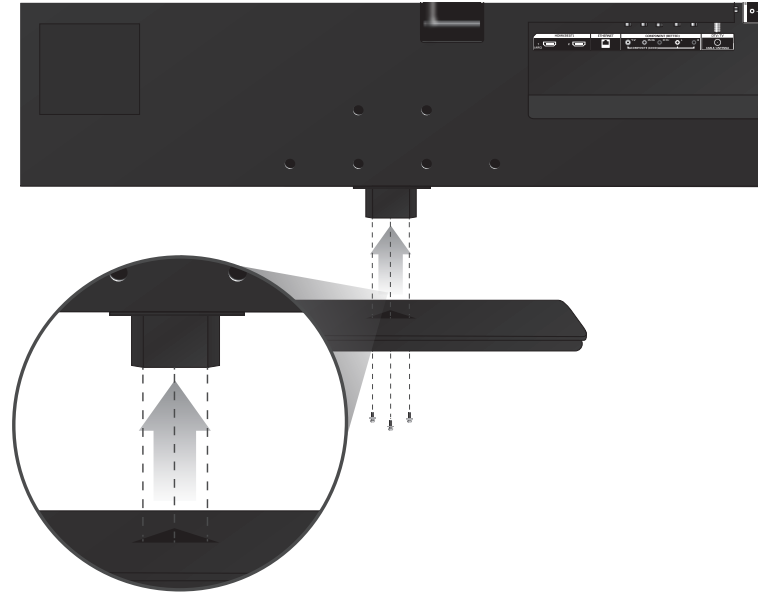

Align the base with the neck and tighten three (3) M6 12mm screws into the base with a Phillips screwdriver.

When you are finished, place the TV on a stable, level surface.

# FIRST-TIME SETUP

- 1 Connect all of your devices first.  
Choose **ONE** connection type for each device.

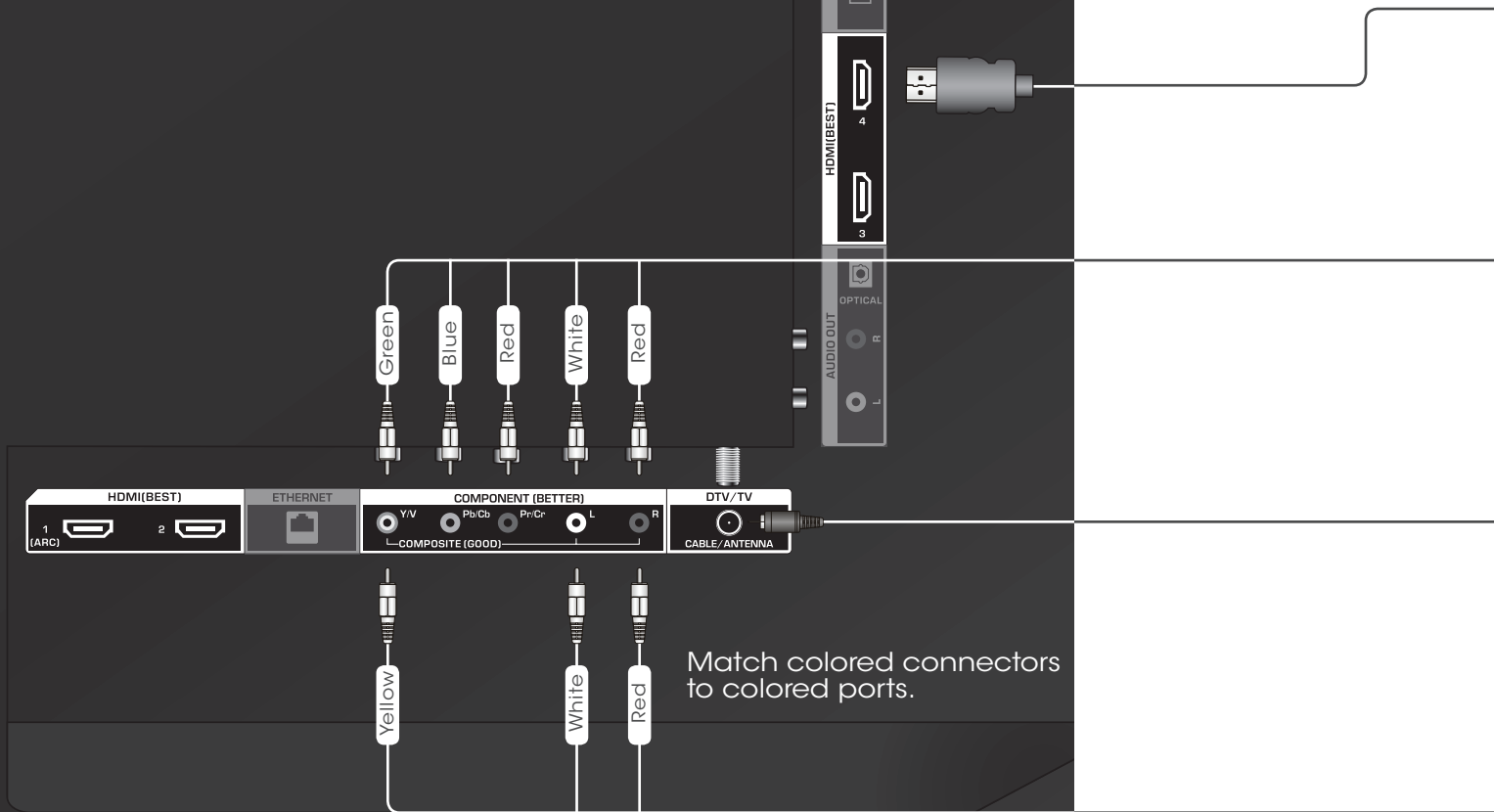

Match colored connectors to colored ports.



HDMI CABLE\*

**BEST**

- DIGITAL
- HD VIDEO (1080p)\*\*
- HD AUDIO



COMPONENT CABLE\*

**BETTER**

- ANALOG
- HD VIDEO (1080i)\*\*
- STEREO AUDIO

Match colored connectors to colored ports.

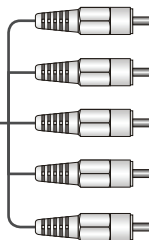

COAXIAL CABLE\*

**BETTER**

- ANALOG
- HD VIDEO (1080i)\*\*
- STEREO AUDIO



AV CABLE\*

**GOOD**

- ANALOG
- VIDEO (480i)\*\*
- STEREO AUDIO

Match colored connectors to colored ports.

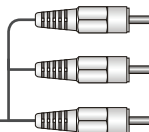

Cable or Satellite Boxes



Blu-ray™ or DVD Players



Game Consoles

\* Cables not included

\*\* Maximum Resolution

# 2

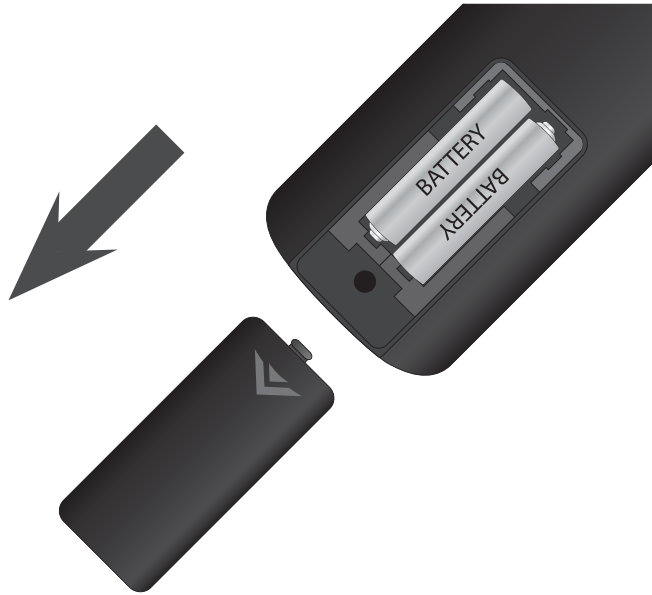

Remove the battery cover by pressing gently on the V logo and sliding away from the remote.  
Insert the included batteries.  
Gently slide the battery cover back into place.

# 3

Back of TV

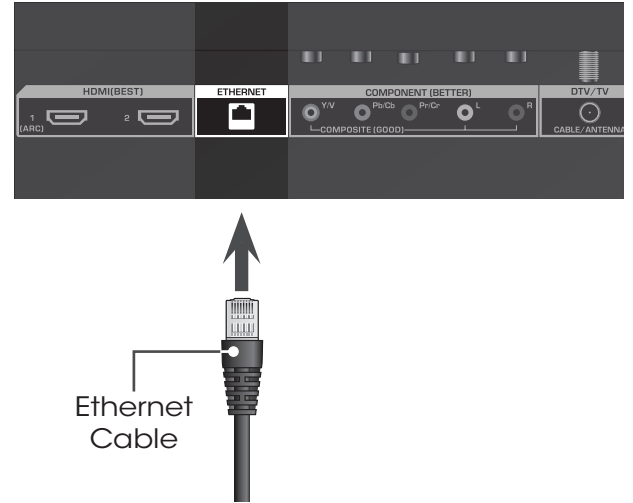

If you have a high-speed internet connection, connect an Ethernet cable from your modem or router to the back of the TV as shown.

For the best Smart TV experience, VIZIO recommends using an Ethernet cable. However, your TV also has built-in Wi-Fi. See the *Connecting to the Internet with Wi-Fi* section for more information.



Connect the power cord to the back of the TV. The flat edge of the connector goes toward the outside of the TV.

Plug the power cord into an electrical outlet.

5

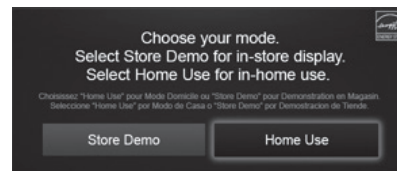

Turn the TV on by pressing the **Power** button on the remote.

The Setup App is displayed.

Use the **Arrow** buttons on the remote to highlight **Home Use** and press **OK**.

Follow the on-screen instructions to complete the first-time setup.

# VIEWING THE ON-SCREEN USER MANUAL

1



MENU  
Button

Press the **MENU** button on the Remote Control to display the TV Settings menu.

2

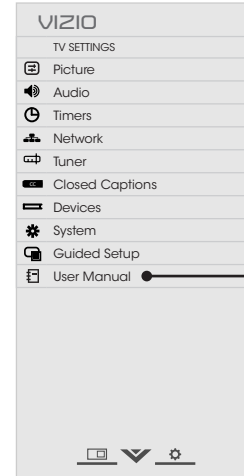

User  
Manual

Highlight **User Manual** and press **OK**.

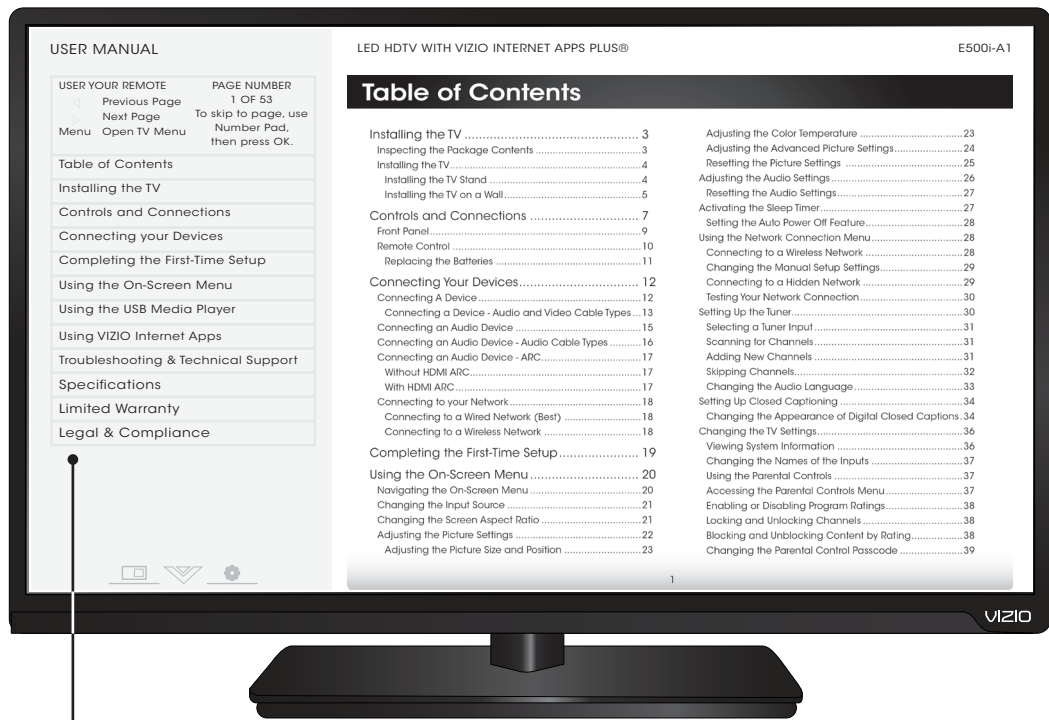

## USER MANUAL

LED HDTV WITH VIZIO INTERNET APPS PLUS®

E500i-A1

USER YOUR REMOTE	PAGE NUMBER
Previous Page	1 OF 53
Next Page	To skip to page, use
Menu	Number Pad, then press OK.
Table of Contents	
Installing the TV	
Controls and Connections	
Connecting your Devices	
Completing the First-Time Setup	
Using the On-Screen Menu	
Using the USB Media Player	
Using VIZIO Internet Apps	
Troubleshooting & Technical Support	
Specifications	
Limited Warranty	
Legal & Compliance	

## Table of Contents

Installing the TV	3	Adjusting the Color Temperature	23
Inspecting the Package Contents	3	Adjusting the Advanced Picture Settings	24
Installing the TV	4	Resetting the Picture Settings	25
Installing the TV Stand	4	Adjusting the Audio Settings	26
Installing the TV on a Wall	5	Resetting the Audio Settings	27
Controls and Connections	7	Activating the Sleep Timer	27
Front Panel	9	Setting the Auto Power Off Feature	28
Remote Control	10	Using the Network Connection Menu	28
Replacing the Batteries	11	Connecting to a Wireless Network	28
Connecting Your Devices	12	Changing the Manual Setup Settings	29
Connecting A Device	12	Connecting to a Hidden Network	29
Connecting a Device - Audio and Video Cable Types	13	Testing Your Network Connection	30
Connecting an Audio Device	15	Setting Up the Tuner	30
Connecting an Audio Device - Audio Cable Types	16	Selecting a Tuner Input	31
Connecting an Audio Device - ARC	17	Scanning for Channels	31
Without HDMI ARC	17	Adding New Channels	31
With HDMI ARC	17	Skipping Channels	32
Connecting to your Network	18	Changing the Audio Language	33
Connecting to a Wired Network (Best)	18	Setting Up Closed Captioning	34
Connecting to a Wireless Network	18	Changing the Appearance of Digital Closed Captions	34
Completing the First-Time Setup	19	Changing the TV Settings	36
Using the On-Screen Menu	20	Viewing System Information	36
Navigating the On-Screen Menu	20	Changing the Names of the Inputs	37
Changing the Input Source	21	Using the Parental Controls	37
Changing the Screen Aspect Ratio	21	Accessing the Parental Controls Menu	37
Adjusting the Picture Settings	22	Enabling or Disabling Program Ratings	38
Adjusting the Picture Size and Position	23	Locking and Unlocking Channels	38
		Blocking and Unblocking Content by Rating	38
		Changing the Parental Control Passcode	39



Use the **Up** and **Down** Arrow buttons to select the chapter you want to view.

Use the **Left** and **Right** Arrow buttons to browse through the pages in each chapter.

Press the **EXIT** button to exit the on-screen User Manual.

# CONNECTING TO THE INTERNET WITH WI-FI

## 1



If you have already set up a wireless connection during the first-time setup, you can skip this section.

To connect to a wireless network you will need:

- Wireless Router
- High-speed Internet connection
- SSID (Wireless network name)
- Network Password

For streaming video, your Internet connection speed should be 1.5 Mbps or higher.

If you don't know how fast your connection speed is, contact your Internet Service Provider (ISP).

## 2

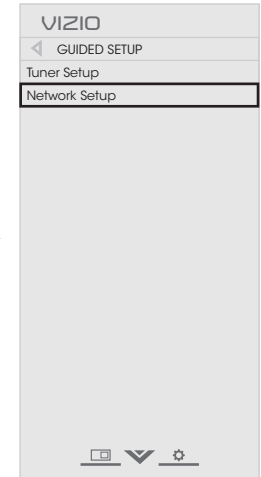
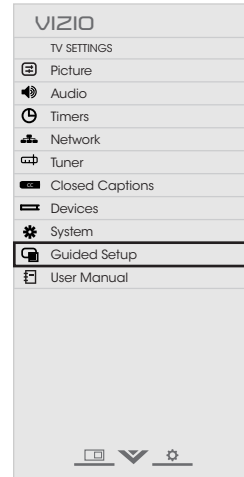

Press the **MENU** button to display the TV SETTINGS menu. Use the **Arrow** buttons to highlight **Guided Setup** and press **OK**. The GUIDED SETUP menu is displayed.

Highlight **Network Setup** and press **OK**. The Network Setup guide is displayed.

# 3

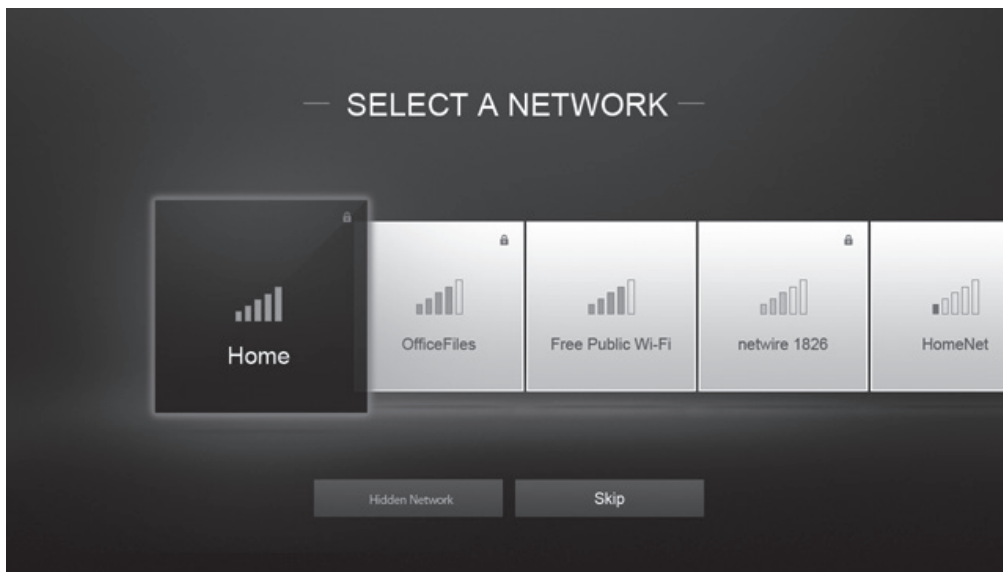

Highlight the name of your wireless network (this is the network's SSID) and press **OK**. If you do not see your SSID, you will need to enter it manually by selecting **Hidden Network**. For more information, see the TV's User Manual. Using the on-screen keyboard, enter your network's password, then highlight **Connect** and press **OK**.



If you are having trouble connecting to your network, check your router placement. It should be in a place with minimal structural interference like walls or large metal objects, and away from any other devices that are broadcasting at 2.4GHz.

# GETTING STARTED WITH VIZIO INTERNET APPS PLUS®

VIZIO Internet Apps Plus® (V.I.A. Plus) delivers popular online content to your TV. V.I.A. Plus features a selection of Apps that allow you to watch movies and TV shows, listen to music, get weather and news information, and more—all on demand.



A high-speed Internet connection is required to receive product updates and to access online content.



Press the **OK** button to launch an App.

Press the **Left/Right** Arrow buttons to scroll through the Apps on the dock. (The highlighted App is in the center of the dock.)

Press the **V Button** to display the V.I.A. Plus App Dock  
Press the **V Button** twice to launch the fullscreen V.I.A. Plus Apps window.



The fullscreen V.I.A. Plus Apps window allows you to add and store apps. The Apps on the first page are displayed in the Dock and Apps on additional pages can be moved to the Dock.

Press the **V Button** twice to launch the fullscreen V.I.A. Plus Apps window.

### My Apps

Features the apps installed on your TV.

### Installed Apps

The Apps displayed here are also available in the V.I.A. Plus App Dock.

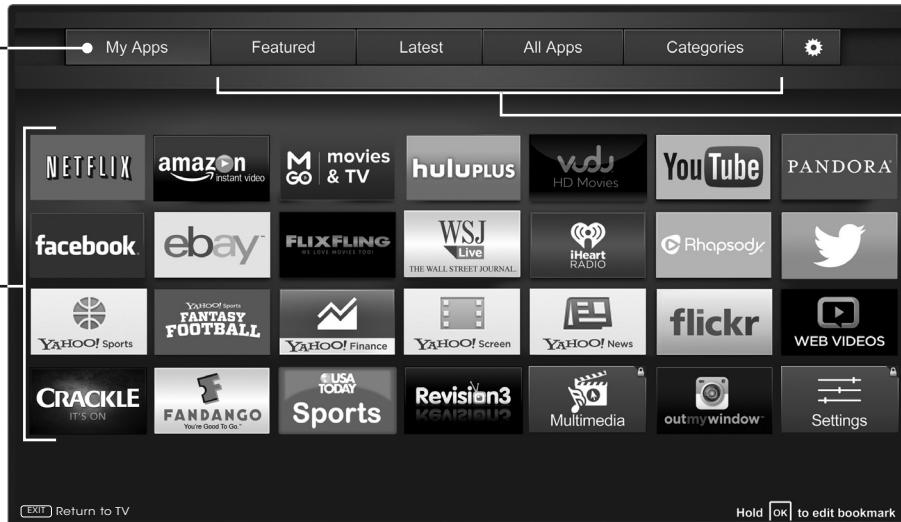

### App Tabs

Browse through apps on these tabs and add them to your My Apps tab.

You can also open the app directly from the app store.

Note: App location, appearance, and availability subject to change without notice.

# HELP TOPICS

How do I return to the Setup App?

- The on-screen menu has guided setup. Press **MENU** > **Guided Setup**. Select the type of setup you need and press **OK**. The Setup App begins.
  - To reset the TV to factory defaults, press **MENU** > **System** > **Reset & Admin** > **Reset TV to Factory Defaults**. If you have changed the default Parental Control Passcode, enter it now. Select **Reset**. Remember that all of your settings will be lost.
- 

There is a picture, but there is no sound.

- Press the **VOLUME UP** button on the remote.
  - Press the **MUTE** button on the remote to ensure that mute is off.
  - Press **MENU**, then select **Audio**. Be sure **TV Speakers** is set to **On**.
- 

The TV displays "No Signal."

- Be sure your connected devices are turned on.
  - Press the **INPUT** button on the remote and select the input to which your device is connected (TV, HDMI-1, COMP, etc.).
- 

There are black/gray bars on the top/bottom/sides of the screen.

- Note that some television channels add black bars to the picture.
  - Set the TV image mode so that the picture fills the screen. Press the **WIDE** button on the remote until the screen is filled, and then press **OK**.
  - Adjust the video settings of your external device,
- 

There is no power.

- Be sure the power cord is securely connected to the AC socket on the TV and to a working electrical outlet.
- Press the **POWER** button on the remote or on the side of the TV.
- If the above steps do not work, try plugging the power cord into a different outlet.

# LEGAL / COMPLIANCE

## FCC Class B Radio Interference Statement

**NOTE:** This equipment has been tested and found to comply with the limits for a Class B digital device, pursuant to Part 15 of the FCC Rules. These limits are designed to provide reasonable protection against harmful interference in a residential installation. This equipment generates, uses and can radiate radio frequency energy, and if not installed and used in accordance with the instructions, may cause harmful interference to radio communications. However, there is no guarantee that interference will not occur in a particular installation. If this equipment does cause harmful interference to radio or television reception, which can be determined by turning the equipment off and on, the user is encouraged to try to correct the interference by one or more of the following measures:

- Reorient or relocate the receiving antenna.
- Increase the separation between the equipment and receiver.
- Connect the equipment into an outlet on a circuit different from that to which the receiver is connected.
- Consult the dealer or an experienced radio/TV technician for help.

This device complies with Part 15 of the FCC Rules. Operation is subject to the following two conditions: (1) this device may not cause harmful interference, and (2) this device must accept any interference received, including interference that may cause undesired operation.

# LIMITED WARRANTY

## ON PARTS AND LABOR

Covers units purchased as new in United States and Puerto Rico Only.

VIZIO provides a warranty to the original purchaser of a new Product against defects in materials and workmanship for a period of one (1) year of non-commercial usage and ninety (90) days of commercial use. If a Product covered by this warranty is determined to be defective within the warranty period, VIZIO will either repair or replace the Product at its sole option and discretion.

To obtain warranty service, contact VIZIO Technical Support via e-mail: TechSupport@VIZIO.com or via phone at 877 MY VIZIO (877.698.4946) from 5:00AM to 8:00PM Monday through Friday and 7:00AM to 4:00PM Saturday and Sunday, Pacific Time, or visit [www.VIZIO.com](http://www.VIZIO.com). PRE-AUTHORIZATION MUST BE OBTAINED BEFORE SENDING ANY PRODUCT TO A VIZIO SERVICE CENTER. Proof of purchase in the form of a purchase receipt or copy thereof is required to show that a Product is within the warranty period.

## Parts and Labor

There will be no charge for parts or labor during the warranty period. Replacement parts and Products may be new or recertified at VIZIO's option and sole discretion. Replacement parts and Products are warranted for the remaining portion of the original warranty or for ninety (90) days from warranty service or replacement, whichever is greater.

## Type of Service

Defective Products must be sent to a VIZIO service center to obtain warranty service. VIZIO is not responsible for transportation costs to the service center, but VIZIO will cover return shipping to the customer. PRE-AUTHORIZATION IS REQUIRED BEFORE SENDING ANY PRODUCT TO A VIZIO SERVICE CENTER FOR WARRANTY SERVICE.

Product returns to VIZIO's service centers must utilize either the original carton box and shipping material or packaging that affords an equal degree of protection. VIZIO Technical Support will provide instructions for packing and shipping the covered Product to the VIZIO service center.

## Limitations and Exclusions

VIZIO's one-year limited warranty only covers defects in materials and workmanship. This warranty does not cover, for example: cosmetic damage, normal wear and tear, improper operation, improper voltage supply or power surges, signal issues, damages from shipping, acts of God, any type of customer misuse, modifications or adjustments, as well as installation and set-up issues or any repairs attempted by anyone other than by a VIZIO authorized service center. Products with unreadable or removed serial numbers, or requiring routine maintenance are not covered. This one year limited warranty does not cover Products sold "AS IS", "FACTORY RECERTIFIED", or by a non-authorized reseller.

## Notice

The changes or modifications not expressly approved by the party responsible for compliance could void the user's authority to operate the equipment.

Shielded interface cables and AC power cord, if any, must be used in order to comply with the emission limits.

The manufacturer is not responsible for any radio or TV interference caused by unauthorized modification to this equipment. It is the responsibilities of the user to correct such interference.

## FCC Warning

Changes or modifications not expressly approved by the party responsible for compliance with the FCC Rules could void the user's authority to operate this equipment.

## Caution

Always use an AC/DC power adapter that is properly grounded. Use the AC cords listed below for each area.

USA: UL	Germany: VDE	Japan: Electric Appliance Control Act
Canada: CSA	UK: BASE/BS	

Image(s) under license from Shutterstock.com.

THERE ARE NO EXPRESS WARRANTIES OTHER THAN THOSE LISTED OR DESCRIBED ABOVE. ANY IMPLIED WARRANTIES, INCLUDING ANY IMPLIED WARRANTY OF MERCHANTABILITY AND FITNESS FOR A PARTICULAR PURPOSE, SHALL BE LIMITED IN DURATION TO THE PERIOD OF TIME SET FORTH ABOVE. VIZIO'S TOTAL LIABILITY FOR ANY AND ALL LOSSES AND DAMAGES RESULTING FROM ANY CAUSE WHATSOEVER INCLUDING VIZIO'S NEGLIGENCE, ALLEGED DAMAGE, OR DEFECTIVE GOODS, WHETHER SUCH DEFECTS ARE DISCOVERABLE OR LATENT, SHALL IN NO EVENT EXCEED THE PURCHASE PRICE OF THE PRODUCT. VIZIO SHALL NOT BE RESPONSIBLE FOR LOSS OF USE, LOSS OF INFORMATION OR DATA, COMMERCIAL LOSS, LOST REVENUE OR LOST PROFITS, OR OTHER INCIDENTAL OR CONSEQUENTIAL DAMAGES. SOME STATES DO NOT ALLOW LIMITATIONS ON HOW LONG AN IMPLIED WARRANTY LASTS OR THE EXCLUSION OF INCIDENTAL OR CONSEQUENTIAL DAMAGES, SO THE ABOVE LIMITATIONS OR EXCLUSIONS MAY NOT APPLY TO YOU. THIS WARRANTY GIVES YOU SPECIFIC LEGAL RIGHTS, AND YOU MAY ALSO HAVE OTHER RIGHTS, WHICH VARY FROM STATE TO STATE. THIS WARRANTY IS SUBJECT TO CHANGE WITHOUT NOTICE.

CHECK [WWW.VIZIO.COM](http://WWW.VIZIO.COM) FOR THE MOST CURRENT VERSION.

## Personal Data

If your VIZIO product is capable of storing personal data and other information, ALL CONTENTS AND INFORMATION WILL BE DELETED IN THE COURSE OF SOME IN-HOME AND ALL SHIP-IN WARRANTY SERVICE. If this occurs, your product will be restored to you configured as originally purchased. You will be responsible for restoring all applicable data and passwords. Recovery and reinstallation of user data is not covered under this Limited Warranty. In order to protect your personal information, VIZIO recommends that you always clear all personal information from the unit before it is serviced, regardless of the service.

## Zero Bright Pixel Defect Guarantee

This policy covers "zero bright pixel" defects for the duration of the limited "ONE YEAR WARRANTY" on select new product purchases. To determine if this guarantee applies to your product, refer to the "DETAILS" tab of the model's product information page ([www.VIZIO.com](http://www.VIZIO.com)) or look for the "zero bright pixel" guarantee on the box.

