

VIZIO



USER MANUAL

Model: M401i-A3



This product qualifies for ENERGY STAR in the "factory default" setting and this is the setting in which power savings will be achieved. Changing the factory default picture settings or enabling other features will increase power consumption that could exceed the limits necessary to qualify for ENERGY STAR rating.



For DTS patents, see

<http://patents.dts.com>.

Manufactured under license from DTS Licensing Limited. DTS, the Symbol, & DTS and the Symbol together are registered trademarks, DTS Studio Sound is a trademark of DTS, Inc. © DTS, Inc. All Rights Reserved.



Manufactured under license from Dolby Laboratories. Dolby and the double-D symbol are trademarks of Dolby Laboratories.



HDMI, the HDMI logo and High-Definition Multimedia Interface are trademarks or registered trademarks of HDMI Licensing LLC.

Welcome

THANK YOU FOR CHOOSING VIZIO

And congratulations on your new VIZIO HDTV.

To get the most out of your new VIZIO product, read these instructions before using your product and retain them for future reference. Be sure to inspect the package contents to ensure there are no missing or damaged parts.

PRODUCT REGISTRATION

To purchase or inquire about accessories and installation services for your VIZIO product, visit our website at www.VIZIO.com or call toll free at (877) 878-4946.

We recommend that you either:

- Register your VIZIO product at www.VIZIO.com
- Complete and mail the enclosed registration card

Extended Warranties

For peace of mind, and to protect your investment beyond the standard warranty, VIZIO offers on-site extended warranty service plans. These plans provide additional coverage during the standard warranty period. To purchase an extended warranty service plan, visit www.VIZIO.com.

WHEN READING THIS MANUAL



When you see this symbol, please read the accompanying important warning or notice. It is intended to alert you to the presence of important operating instructions.



When you see this symbol, please read the accompanying helpful tip.

IMPORTANT SAFETY INSTRUCTIONS

Your TV is designed and manufactured to operate within defined design limits. Misuse may result in electric shock or fire. To prevent your TV from being damaged, the following instructions should be observed for the installation, use, and maintenance of your TV. Read the following safety instructions before operating your TV. Keep these instructions in a safe place for future reference.

- To reduce the risk of electric shock or component damage, switch off the power before connecting other components to your TV.
- Read these instructions.
- Keep these instructions.
- Heed all warnings.
- Follow all instructions.
- Do not use this apparatus near water.
- Clean only with a dry cloth.
- Do not block any ventilation openings. Install in accordance with the manufacturer's instructions.
- Do not install near any heat sources such as radiators, heat registers, stoves, or other apparatus (including amplifiers) that produce heat.
- Do not defeat the safety purpose of the polarized or grounding-type plug. A polarized plug has two blades and a third grounding prong. The wide blade or the third prong are provided for your safety. If the provided plug does not fit into your outlet, consult an electrician for replacement of the obsolete outlet.
- Protect the power cord from being walked on or pinched, particularly at plugs, convenience receptacles, and the point where they exit from the apparatus.
- Only use attachments/accessories specified by the manufacturer.

- Use only with the cart, stand, tripod, bracket, or table specified by the manufacturer, or sold with the apparatus. When a cart is used, use caution when moving the cart/apparatus combination to avoid injury from tip-over.
- Unplug this apparatus during lightning storms or when unused for long periods of time.
- Refer all servicing to qualified service personnel. Servicing is required when the apparatus has been damaged in any way, such as when the power-supply cord or plug is damaged, liquid has been spilled or objects have fallen into the apparatus, the apparatus has been exposed to rain or moisture, does not operate normally or has been dropped.
- Unplug the power cord before cleaning your TV.
- When moving your TV from an area of low temperature to an area of high temperature, condensation may form in the housing. Wait before turning on your TV to avoid causing fire, electric shock, or component damage.
- A distance of at least three feet should be maintained between your TV and any heat source, such as a radiator, heater, oven, amplifier etc. Do not install your TV close to smoke. Operating your TV close to smoke or moisture may cause fire or electric shock.
- Slots and openings in the back and bottom of the cabinet are provided for ventilation. To ensure reliable operation of your TV and to protect it from overheating, be sure these openings are not blocked or covered. Do not place your TV in a bookcase or cabinet unless proper ventilation is provided.
- Never push any object into the slots and openings on your TV cabinet. Do not place any objects on the top of your TV. Doing so could short circuit parts causing a fire or electric shock. Never spill liquids on your TV.
- Your TV should be operated only from the type of power source indicated on the label. If you are not sure of the type of power supplied to your home, consult your dealer



- or local power company.
- Do not apply pressure or throw objects at your TV. This may compromise the integrity of the display. The manufacturer's warranty does not cover user abuse or improper installations.
- The power cord must be replaced when using different voltage than the voltage specified. For more information, contact your dealer.
- When connected to a power outlet, power is always flowing into your TV. To totally disconnect power, unplug the power cord.
- The lightning flash with arrowhead symbol within an equilateral triangle is intended to alert the user to the presence of un-isolated, dangerous voltage within the inside of your TV that may be of sufficient magnitude to constitute a risk of electric shock to persons.
- Do not overload power strips and extension cords. Overloading can result in fire or electric shock.
- The wall socket should be installed near your TV and easily accessible.
- Only power of the marked voltage can be used for your TV. Any other voltage than the specified voltage may cause fire or electric shock.
- Do not touch the power cord during lightning. To avoid electric shock, avoid handling the power cord during electrical storms.
- Unplug your TV during a lightning storm or when it will not be used for long period of time. This will protect your TV from damage due to power surges.
- Do not attempt to repair or service your TV yourself. Opening or removing the back cover may expose you to high voltages, electric shock, and other hazards. If repair is required, contact your dealer and refer all servicing to qualified service personnel.
- **WARNING:** Keep your TV away from moisture. Do not expose your TV to rain or moisture. If water penetrates into

your TV, unplug the power cord and contact your dealer. Continuous use in this case may result in fire or electric shock.

- Do not use your TV if any abnormality occurs. If any smoke or odor becomes apparent, unplug the power cord and contact your dealer immediately. Do not try to repair your TV yourself.
- Avoid using dropped or damaged appliances. If your TV is dropped and the housing is damaged, the internal components may function abnormally. Unplug the power cord immediately and contact your dealer for repair. Continued use of your TV may cause fire or electric shock.
- Do not install your TV in an area with heavy dust or high humidity. Operating your TV in environments with heavy dust or high humidity may cause fire or electric shock.
- Follow instructions for moving your TV. Ensure that the power cord and any other cables are unplugged before moving your TV.
- When unplugging your TV, hold the AC/DC power adapter, not the cord. Pulling on the power cord may damage the wires inside the cord and cause fire or electric shock. When your TV will not be used for an extended period of time, unplug the power cord.
- To reduce risk of electric shock, do not touch the connector with wet hands.
- Insert batteries in accordance with instructions. Incorrect polarities may cause the batteries to leak which can damage the remote control or injure the operator. Do not expose batteries to excessive heat such as sunshine, fire or the like.
- If any of the following occurs, contact the dealer:
 - The power cord fails or frays.
 - Liquid sprays or any object drops into your TV.
 - Your TV is exposed to rain or other moisture.
 - Your TV is dropped or damaged in any way.
 - The performance of your TV changes substantially.

- This apparatus shall not be exposed to dripping or splashing and no objects filled with liquids, such as vases, shall be placed on the apparatus.
- The mains plug or appliance coupler is used as the disconnect device, the disconnect device shall remain readily operable.
- CAUTION - These servicing instructions are for use by qualified service personnel only. To reduce the risk of electric shock, do not perform any servicing other than that contained in the operating instructions unless you are qualified to do so.



The lightning flash with arrowhead symbol within an equilateral triangle is intended to alert the user to the presence of uninsulated DANGEROUS VOLTAGE within the product's enclosure that may be of sufficient magnitude to constitute a risk of electrical shock to persons.

TELEVISION ANTENNA CONNECTION PROTECTION

If an outside antenna/satellite dish or cable system is to be connected to the TV, make sure that the antenna or cable system is electrically grounded to provide some protection against voltage surges and static charges.

Article 810 of the National Electrical Code, ANSI/NFPA 70, provides information with regard to proper grounding of the mast and supporting structure, grounding of the lead-in wire to an antenna discharge unit, size of the grounding conductors, location of antenna discharge unit, connection to grounding electrodes, and requirements of the grounding electrode.

Lightning Protection

For added protection of the TV during a lightning storm or when it is left unattended or unused for long periods of time, unplug the TV from the wall outlet and disconnect the antenna or cable system.

Power Lines

Do not locate the antenna near overhead light or power circuits, or where it could fall into such power lines or circuits. Remember, the screen of the coaxial cable is intended to be connected to earth in the building installation.

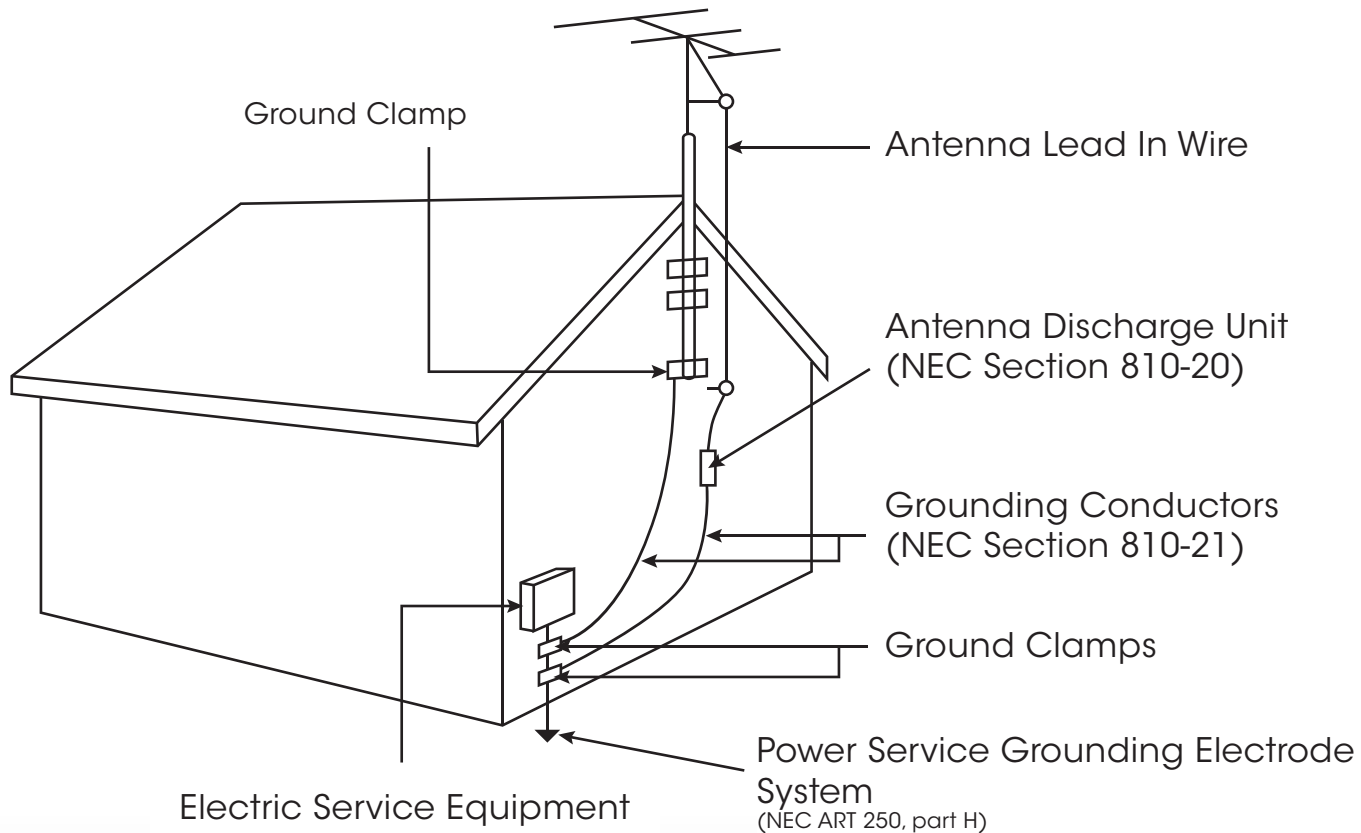

Table of Contents

Installing the TV	3	Adjusting the Professional Picture Settings.....	24
Inspecting the Package Contents	3	Adjusting the Color Tuner Settings	24
Installing the TV.....	3	Creating a Custom Picture Mode	27
Installing the TV Stand	3	Renaming a Custom Picture Mode	28
Installing the TV on a Wall.....	5	Locking a Custom Picture Mode	28
Deleting a Custom Picture Mode	29	Adjusting the Audio Settings.....	30
Controls and Connections	6	Setting up an Audio Device.....	31
Rear Panel	6	Changing the Equalizer Settings.....	32
Front Panel.....	7	Deleting the Custom Audio Mode.....	33
Remote Control	8	Setting Timers.....	34
Replacing the Batteries	9	Setting the Sleep Timer	34
Connecting Your Devices.....	10	Setting the Auto Power Off Feature	34
Connecting A Device	10	Using the Network Connection Menu.....	35
Connecting a Device - Audio and Video Cable Types ...	11	Connecting to a Wireless Network	35
Connecting an Audio Device	13	Changing the Manual Setup Settings.....	35
Connecting an Audio Device - Audio Cable Types.....	14	Finding MAC Addresses for Network Setup	36
Connecting an Audio Device - ARC.....	15	Connecting to a Hidden Network	36
Connecting to your Network	16	Setting Up the Tuner.....	37
Connecting to a Wired Network (Best)	16	Selecting a Tuner Input	37
Connecting to a Wireless Network	16	Scanning for Channels.....	37
Completing the First-Time Setup.....	17	Adding New Channels	38
Using the On-Screen Menu	19	Skipping Channels.....	39
Navigating the On-Screen Menu	19	Listening to Alternate Audio	40
Changing the Input Source	20	Changing the Analog Audio Language	40
Changing the Screen Aspect Ratio	20	Changing the Digital Audio Language.....	40
Viewing Video with the Menu Open	21	Setting Up Closed Captioning	41
Adjusting the Picture Settings	22	Changing the Appearance of Digital Closed Captions .	41
Adjusting the Advanced Picture Settings.....	23	Setting Up Devices.....	43

Pairing a VIZIO Remote Control	43
Pairing a New Device.....	44
Unpairing a Device	46
Renaming Devices on the Input Menu	47
Changing the TV Settings.....	48
Viewing System Information	48
Using the Parental Controls	49
Accessing the Parental Controls Menu	49
Enabling or Disabling Program Ratings.....	49
Locking and Unlocking Channels	49
Blocking and Unblocking Content by Rating.....	50
Changing the Parental Control PIN	50
Resetting the Content Locks.....	50
Changing the On-Screen Menu Language	51
Setting the Time and Local Settings	51
Adjusting the CEC Settings.....	52
Turning the Power Indicator On or Off.....	52
Using the Reset & Admin Menu.....	53
Restoring the TV to Factory Default Settings	53
Using the Guided Setup Menu	53
Using Guided Setup.....	53
Using the Info Window	54
Using the USB Media Player	55
Using the USB Media Player.....	55
Preparing your USB Drive to Play USB Media	55
Playing USB Media	55
Removing the USB drive from the TV.....	55
Using VIZIO Internet Apps Plus® (V.I.A. Plus)	59

Using the V.I.A. Plus App Dock	59
Using the Hot Keys.....	59
Using the fullscreen V.I.A. Plus Apps Window.....	60
To open the Fullscreen V.I.A. Plus Apps Window:.....	60
Fullscreen V.I.A. Plus Apps Window Overview	61
Customizing the V.I.A. Plus Apps Window	62
Adding an App to the My Apps Tab	62
Deleting an App from the My Apps Tab	62
Moving an App in My Apps	63
Troubleshooting & Technical Support	64
Specifications	67
Limited Warranty.....	69
Legal & Compliance.....	70

INSPECTING THE PACKAGE CONTENTS

Before installing your new TV, take a moment to inspect the package contents. Use the images below to ensure nothing is missing or damaged.



VIZIO LED HDTV with Stand



Remote Control with Batteries



Quick Start Guide



Power Cord



3 x 20mm M5 Phillips Screws

PACKAGE CONTENTS

INSTALLING THE TV

After removing the TV from the box and inspecting the package contents you can begin installing the TV. Your TV can be installed in two ways:

- On a flat surface, using the included stand
- On a wall, using a VESA-standard wall mount (not included)

Installing the TV Stand

Your TV includes a stand designed to support the weight of the TV and keep it from falling over. However, the TV can still fall over if:

- It is placed on an uneven, unstable, or non-level surface
- It is pushed, pulled, or otherwise improperly moved
- If an earthquake occurs and the TV is not properly secured



TV ON STAND

To install the base:

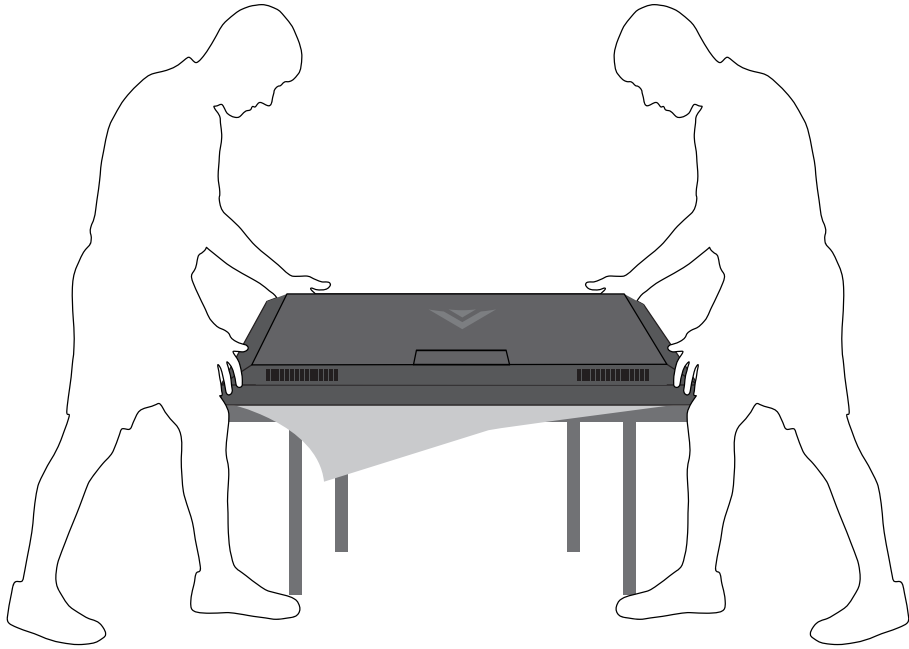

1. It is recommended that two people take part in the base installation.

Remove any plastic wrapping from the TV and stand.

Place the TV screen-down on a clean, flat surface. To prevent scratches or damage to the screen, place the TV on a soft surface, such as carpet, rug, or blanket.

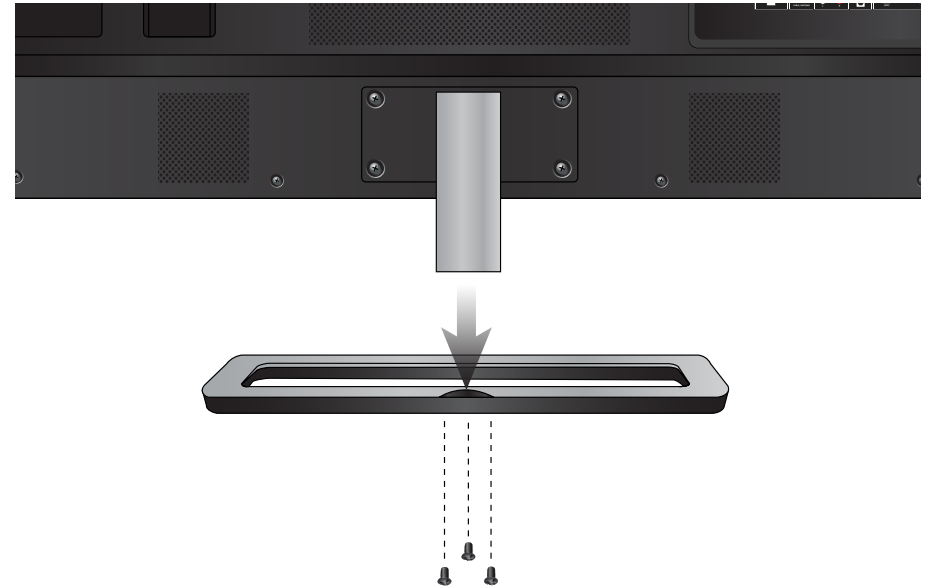

2. Align and slide the neck into the TV base. Insert and tighten three(3) Phillips screws into the bottom of the TV as shown.
3. When you are finished, place the TV on a stable, level surface



Installing the TV on a Wall

To mount your TV on a wall, you will need a wall mount. Consult the information below to find the appropriate mount for your TV model:



Installing a TV on a wall requires lifting. To prevent injury or damage to the TV, ask someone to help you.

M401i-A3	
Screw Size:	M6
Hole Pattern:	200mm (V) x 200mm (H)

Be sure the mount you choose is capable of supporting the weight of the TV. After you have determined that you have the correct mount for your TV, you can begin the installation.

To install your TV on a wall:

1. Disconnect any cables connected to your TV.
2. Place the TV face-down on a clean, flat, stable surface. Be sure the surface is clear of debris that can scratch or damage the TV.
3. Remove the base and neck by loosening and removing the screws.
4. Attach your TV and wall mount to the wall, carefully following the instructions that came with your mount.

Use only with a UL-listed wall mount bracket rated for the weight/load of this TV. See *Appendix B - Specifications* for the weight of this TV.

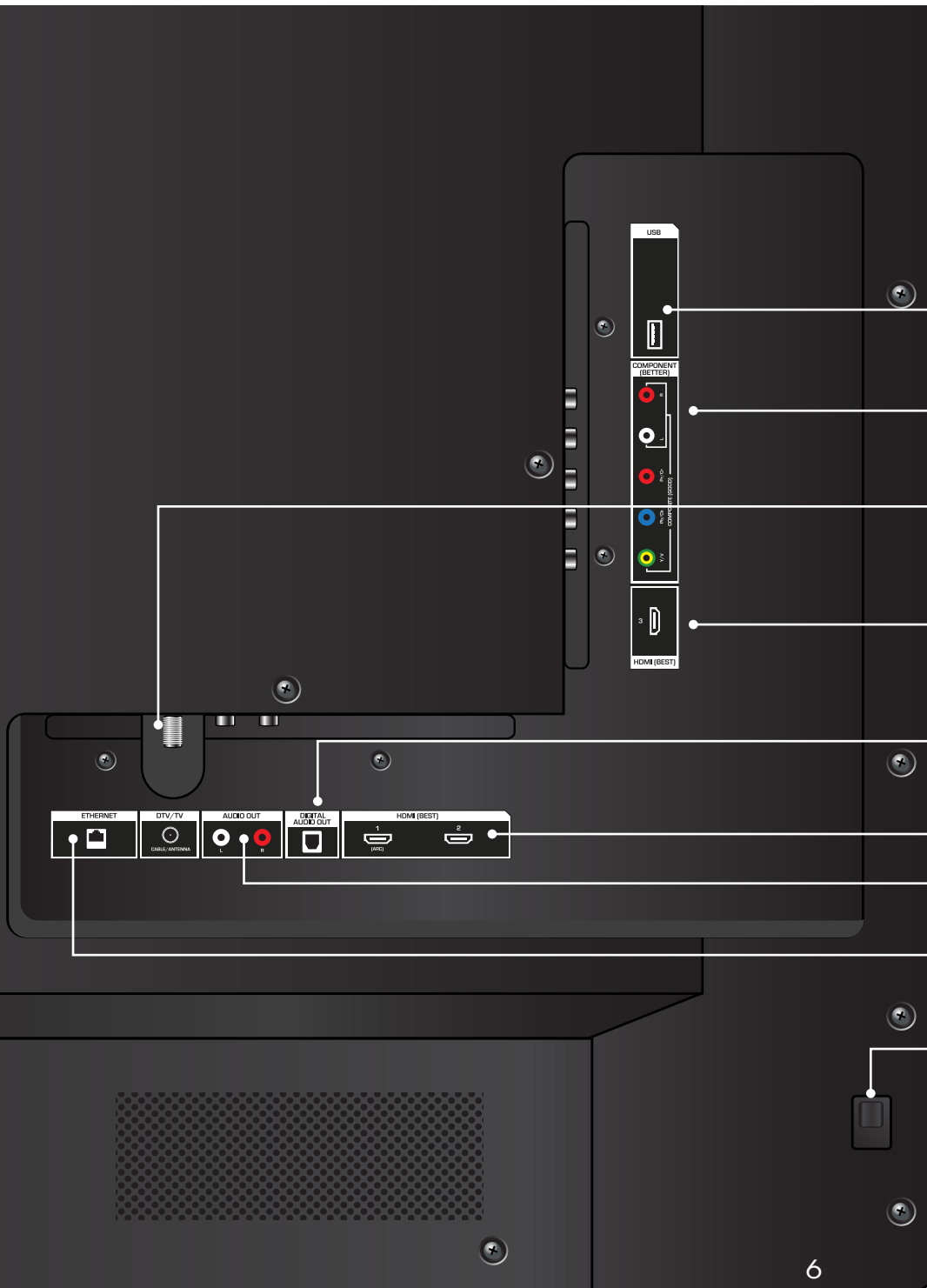

USB - Connect USB thumb drive to play photo, music, or video.

Component/Composite - Connect component or composite device.

Coaxial - Connect coaxial cable from cable, satellite, or antenna.

HDMI - Connect HDMI device.

Optical Audio Out - Connect optical/SPDIF audio device, such as home audio receiver.

HDMI - Connect HDMI device.

Stereo Audio Out - Connect RCA audio device, such as sound bar.

Ethernet - Connect Ethernet cable from home network.

Power/Input - Press once to turn on the TV. Press once to access the input menu. Press and hold to turn off the TV.

REAR PANEL



REMOTE SENSOR & POWER INDICATOR

When using the remote, aim it directly at this sensor.

FRONT PANEL

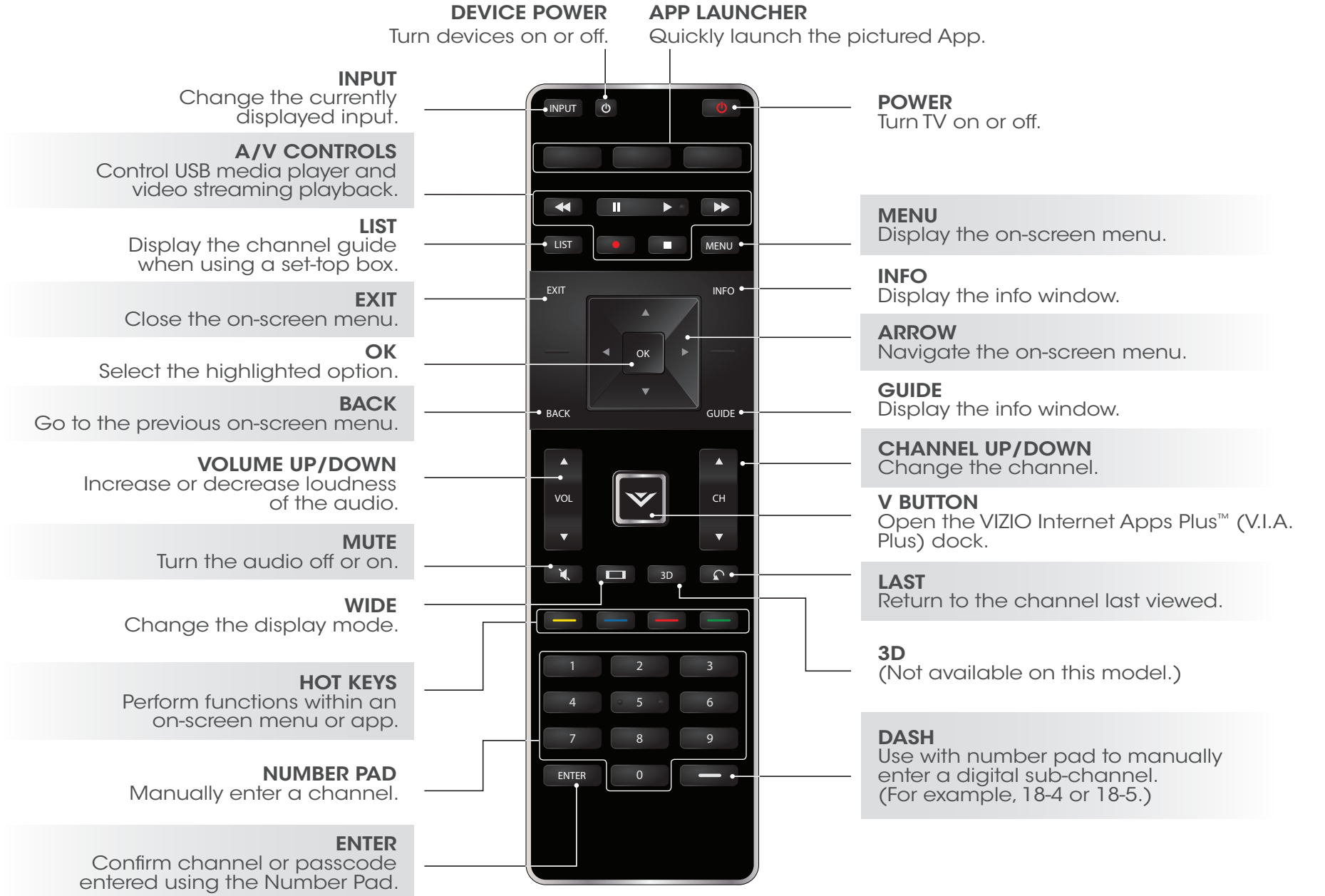

REMOTE CONTROL

Replacing the Batteries



1. Remove the battery cover.
2. Insert two batteries into the remote control. Make sure that the (+) and (-) symbols on the batteries match the (+) and (-) symbols inside the battery compartment.
3. Replace the battery cover.

CONNECTING A DEVICE

Your TV can be used to display output from most devices.

1. Verify that your device has a video port that matches an available port on the TV (HDMI, Component, etc).
2. Turn the TV and your device off.
3. Connect the appropriate cable (not included) to the TV and the device.
4. Turn the TV and your device on. Set the TV's input to match the connection you used (HDMI-1, HDMI-2, etc).



Cable/Satellite Box



Game Console



DVD/Blu-ray Player

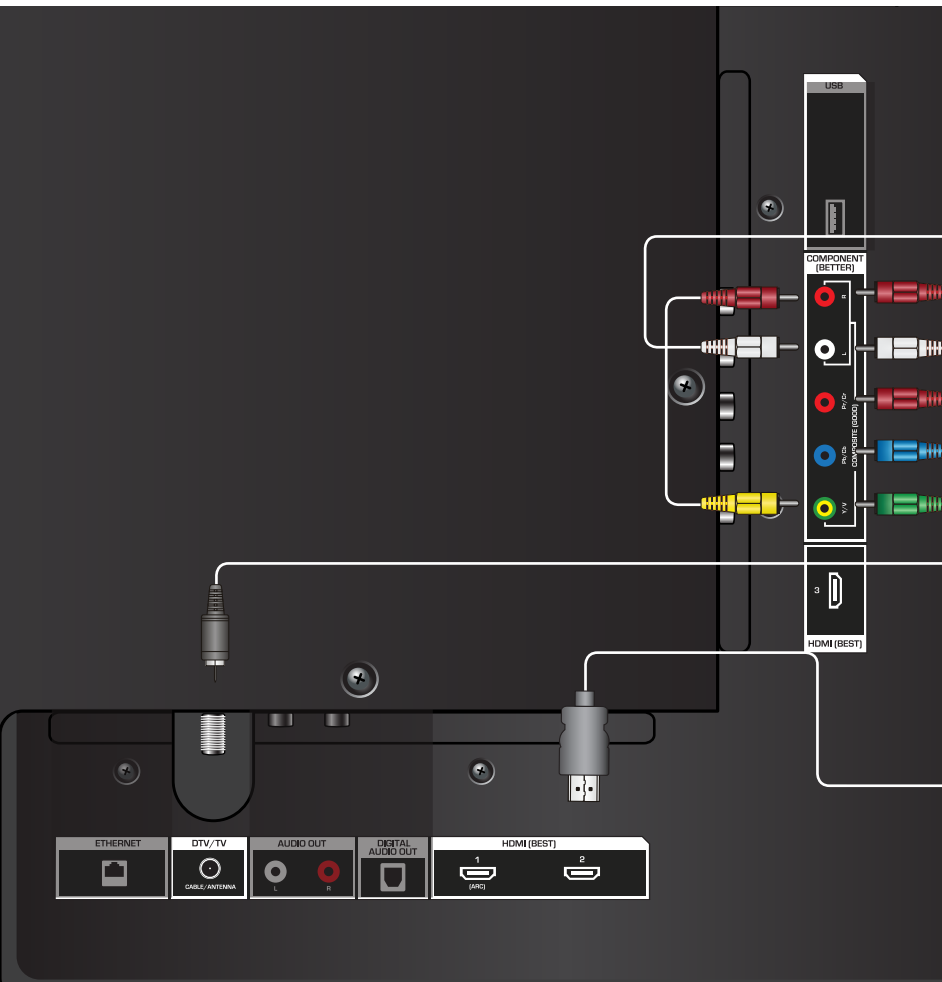

AV CABLE
GOOD

- ANALOG
- VIDEO (480i)*
- STEREO AUDIO

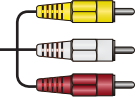

COMPONENT CABLE
BETTER

- ANALOG
- HD VIDEO (1080i)*
- STEREO AUDIO

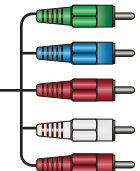

Coaxial CABLE
BETTER

- ANALOG
- HD VIDEO (1080i)*
- STEREO AUDIO



HDMI CABLE
BEST

- DIGITAL
- HD VIDEO (1080p)*
- HD AUDIO



CONNECTING A DEVICE - AUDIO AND VIDEO CABLE TYPES

AV CABLE

AV cables (or Composite cables) are the traditional way of connecting your devices to your TV. Video signals are sent over the yellow connector while audio is sent over the red and white connectors.

- Video Resolutions up to 480i
- Analog Connection
- Audio and Video Signals

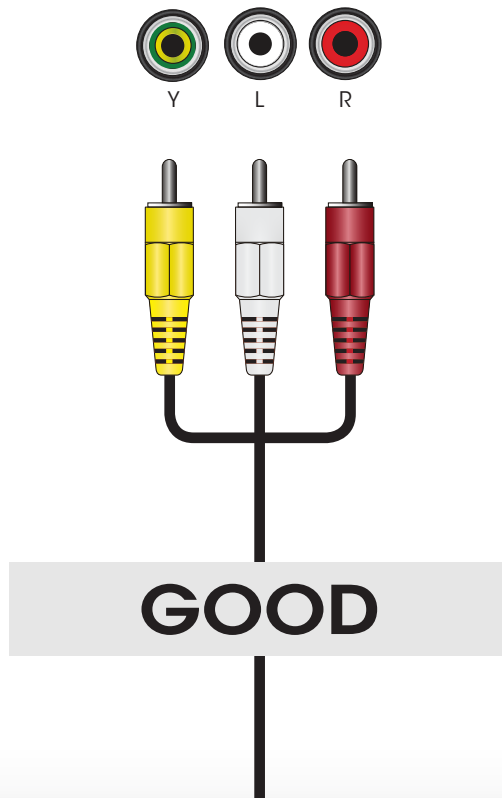

COAXIAL CABLE

Coaxial cables are the traditional way of connecting antennas and cable television signals to your TV. Coaxial cables carry both audio and video signals through a single connector.

- HD Video Resolutions up to 1080i
- Analog Connection
- Audio and Video Signals

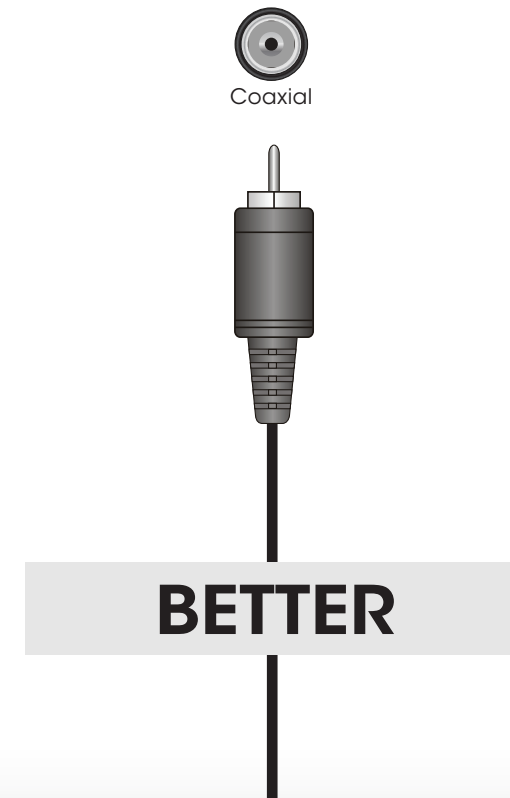

COMPONENT CABLE

Component cables are designed to carry high definition video signals along with additional audio connections. Colors are delivered with color information split up three different ways over three connectors for video (separated into Red, Blue and Green signals) and the left and right audio connectors (Red and White).

- **HD Video Resolutions up to 1080i**
- **Analog Connection**
- **Audio and Video Signals**

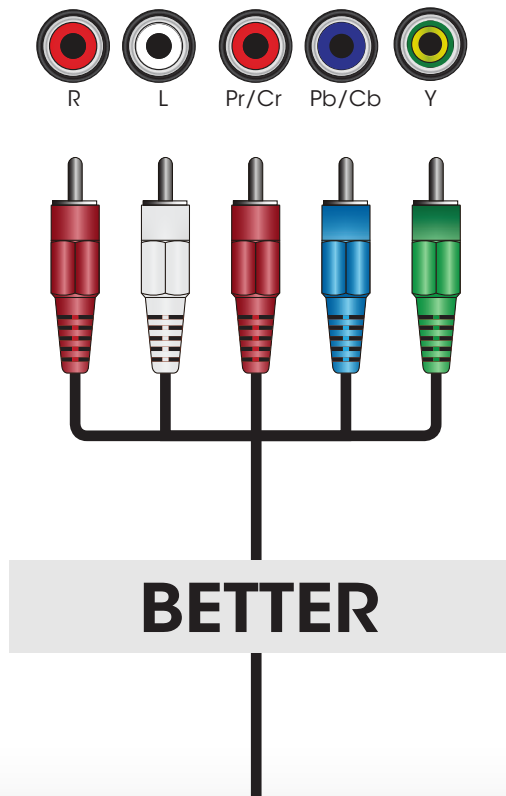

HDMI CABLE

HDMI is the intelligent, all-digital interface that delivers both dazzling quality and unmatched ease of use. HDMI technology transmits crystal-clear digital video along with multi-channel surround audio. HDMI-connected devices have the ability to automatically adjust themselves for optimal viewing.

- **HD Video Resolutions up to 1080p**
- **HD Audio**
- **Digital Connection**
- **Audio and Video Signals**



CONNECTING AN AUDIO DEVICE

Your TV can output sound to an audio device, such as a receiver or sound bar.

1. Verify that your device has an audio port that matches an available port on the TV (Optical, RCA, etc).
2. Turn the TV and your audio device off.
3. Connect the appropriate cable (not included) to the TV and the device.
4. Turn the TV and your device on.

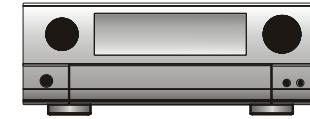

Home Audio Receiver



VIZIO Sound Bar

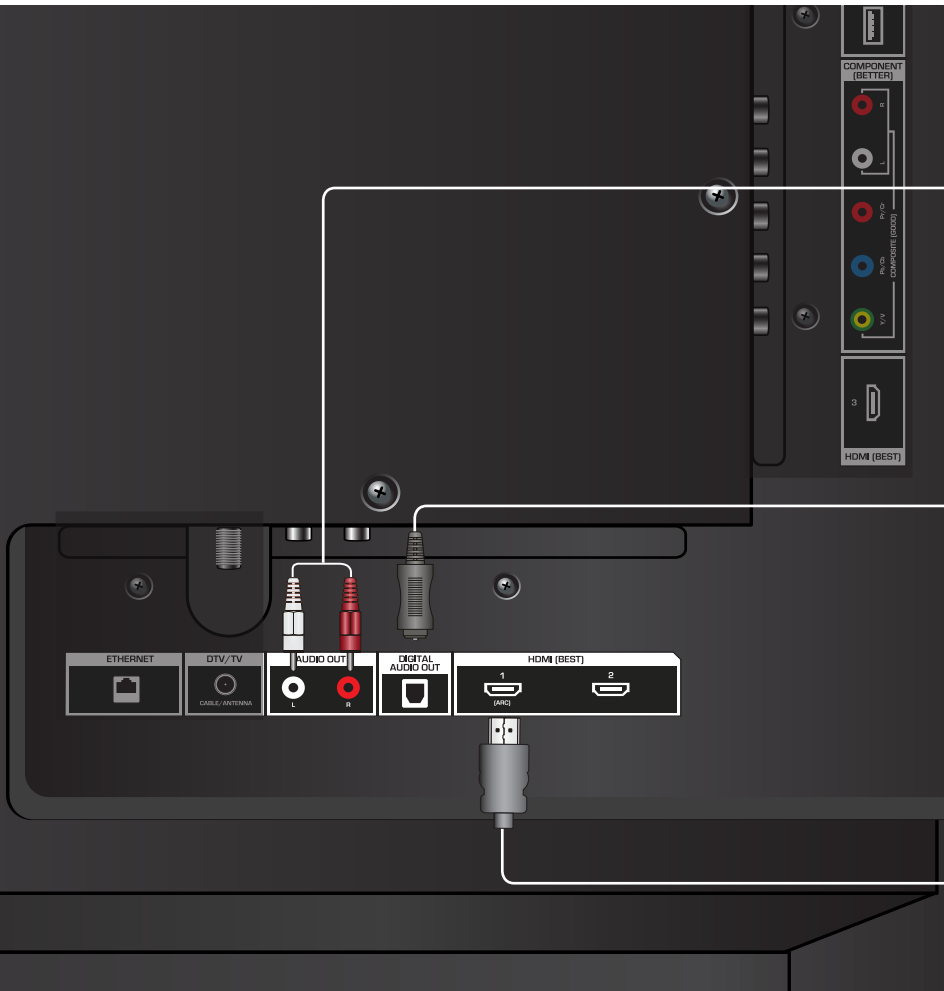

RCA CABLE
GOOD

- ANALOG STEREO CONNECTION
- 2.0 CHANNEL

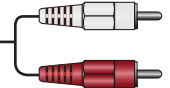

OPTICAL/SPDIF CABLE
BETTER

- PCM STREAM
- DOLBY DIGITAL 5.1 CHANNEL
- DTS 5.1 CHANNEL



HDMI CABLE
BEST

- ARC 2-WAY COMMUNICATION
- 2.0-5.1 DIGITAL AUDIO
- PCM, DTS, DOLBY DIGITAL



CONNECTING AN AUDIO DEVICE - AUDIO CABLE TYPES

RCA CABLE

AV cables (or Composite cables) are the traditional way of connecting your devices to your audio device. Audio signals are sent over the red and white connectors.

- **Quality Stereo Connection**
- **2.0 Channel**
- **Analog Connection**
- **Audio Signal Only**

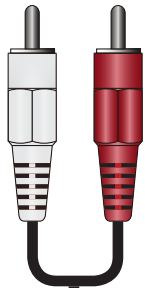

GOOD

OPTICAL/SPDIF CABLE

Optical/SPDIF cables transmit audio signals as pulses of light through a cable made of plastic fibers. Audio signals are digitally transmitted between devices.

- **PCM Stream (Lossless)**
- **Dolby Digital 5.1 Channel**
- **DTS 5.1 Channel**
- **Digital Connection**
- **Audio Signal Only**



Optical/SPDIF



BETTER

HDMI CABLE

HDMI technology transmits crystal-clear digital multi-channel surround audio through a single HDMI cable. Audio Return Channel-enabled (ARC) TVs allow audio to be sent over an already connected HDMI cable, eliminating the need for a separate audio cable. See *Connecting an Audio Device - ARC* on page 15.

- **ARC 2-way Communication (Auto setup)**
- **PCM, DTS, Dolby Digital**
- **2.0 - 5.1 Scalable Lossless Digital Audio Connection**
- **Audio and Video Signals**



HDMI



BEST

CONNECTING AN AUDIO DEVICE - ARC

Without HDMI ARC

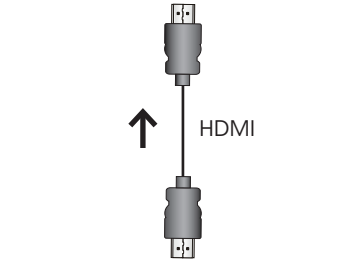
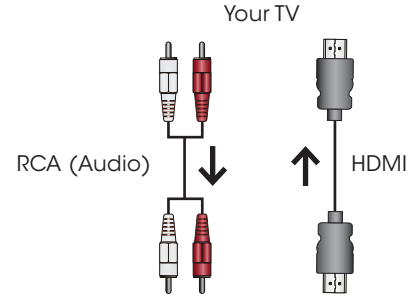
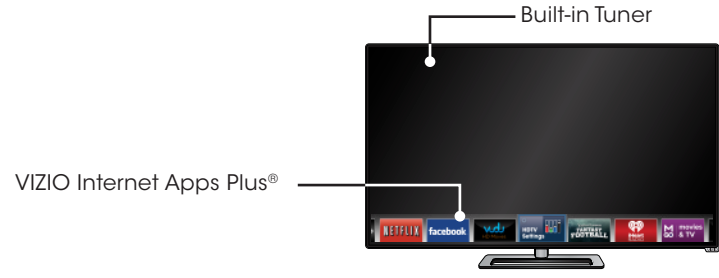

Without an HDMI ARC setup, your TV will transmit audio signal from the built-in tuner and VIA apps to your home audio receiver through a separate audio connection.

With HDMI ARC

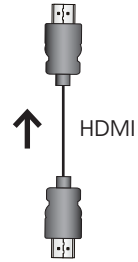
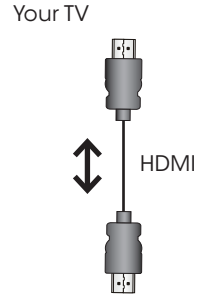
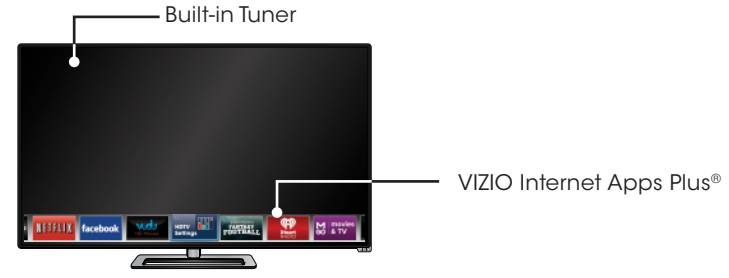

With an HDMI ARC setup, the audio connection between your TV and Home Audio Receiver can be removed. The HDMI cable will transmit audio signal to and from your TV with an all-digital audio/video connection.

CONNECTING TO YOUR NETWORK

Your TV is Internet-ready. It can be connected to your home network with a Wired or Wireless connection.

Connecting to a Wired Network (Best)

1. Connect an Ethernet cable to your router and to the Ethernet port on the back of the TV. See below.
2. Use the Guided Network Setup to configure the TV. See *Using Guided Setup on page 53*.

Connecting to a Wireless Network

1. Ensure you have a router or modem broadcasting as high-speed wireless signal (802.11n recommended).
2. Use the Guided Network Setup to configure the TV. See *Using Guided Setup on page 53*.

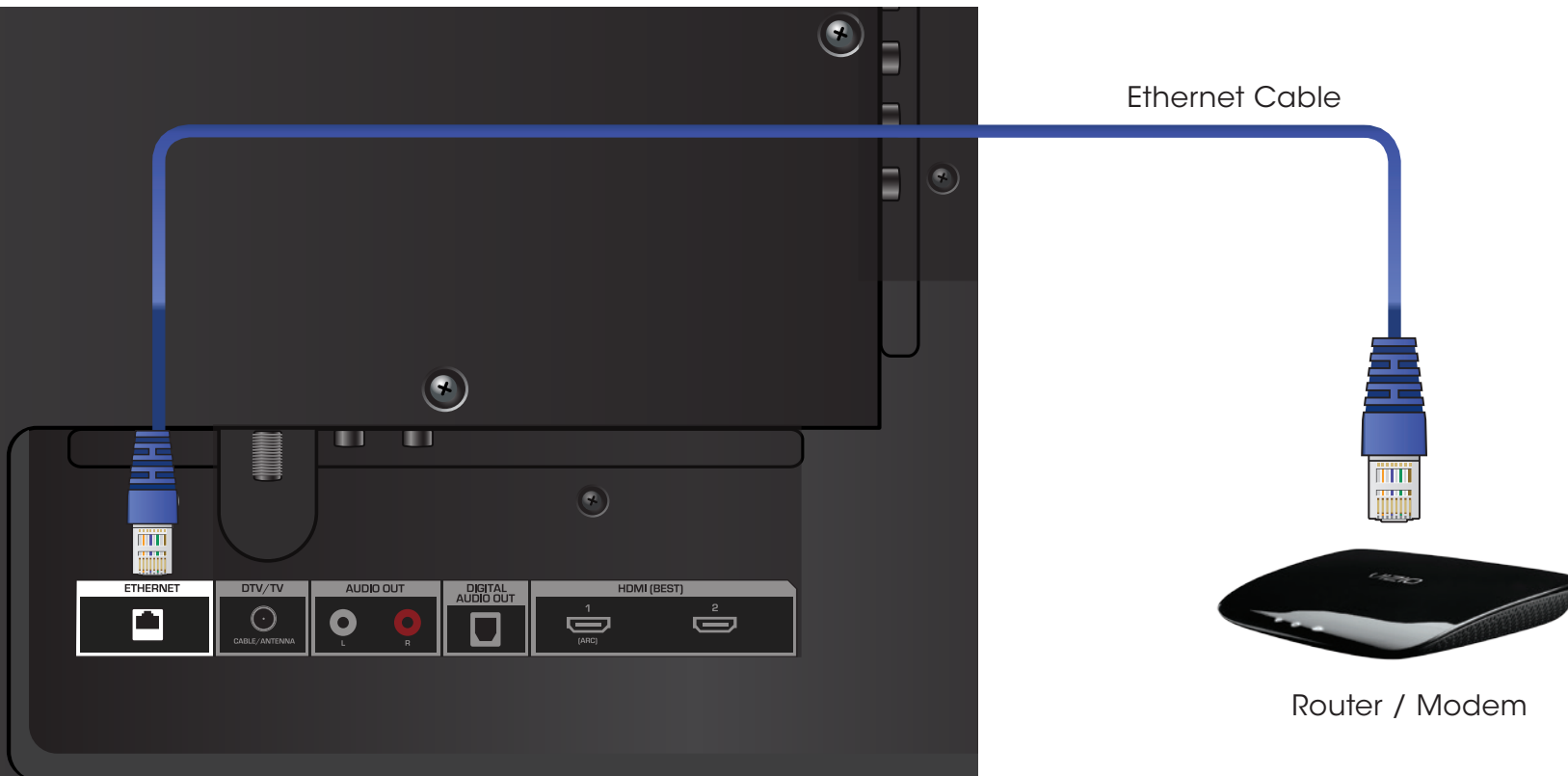

The first time you turn on the TV, the Setup App will guide you through each of the steps necessary to get your TV ready for use.

Before you begin the first-time setup:

- Your TV should be installed and the power cord should be connected to an electrical outlet.
- Your devices should be connected.
- If you have a wireless network, have the network password ready.
- If you are connecting to your network with an Ethernet cable, connect it to the Ethernet port on the TV.

To complete the first-time setup:

1. Press the **Power** button on the remote. The TV powers on and the Setup App starts.



2. Use the **Arrow** buttons on the remote to highlight **Home Use** and press **OK**.

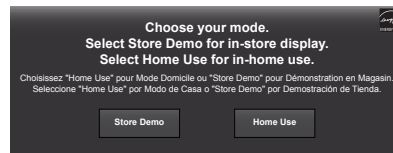

3. Use the **Arrow** buttons on the remote to highlight your language of preference and press **OK**. Then highlight your country and press **OK**.



4. **Press and hold** the **red Record** button and **green Hotkey** button for 5 seconds to pair the Wi-Fi Direct remote.

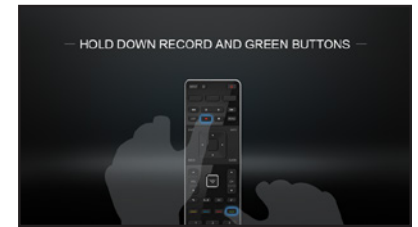

5. Select the name of your wireless network from the list of available networks and press **OK**.



Enter the network password using the on-screen keyboard, then highlight **Connect** and press **OK**.

6. Use the **Arrow** and **OK** buttons on the remote to review the Terms and Conditions and Privacy Policy. When you are finished, highlight **I Accept** and press **OK**.

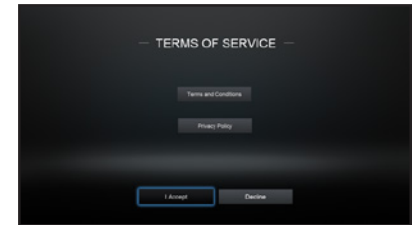

7. Enter your E-mail Address, First Name, Last Name, and ZIP Code using the on-screen keyboard.

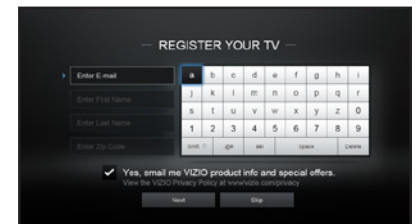

Highlight **Next** and press **OK**.

8. Use the **Arrow** and **OK** buttons on the remote to answer the question about your TV connection and then perform the channel scan or set up your cable or satellite device.



9. Use the **Arrow** and **OK** buttons on the remote to select/enter a device type, input, device brand, and device model, then follow the on-screen instructions to finish setting up your device(s).



For more information see *Setting Up Devices on page 43*.

10. When you have finished the device setup, highlight **Finished** and press **OK**.

The First-Time Setup is complete.

Your TV features an easy-to-use on-screen menu.

To open the on-screen menu, press the **MENU** button on the remote. You can also open the on-screen menu by pressing the **VIA** button and selecting **HDTV Settings** from the VIA Dock, then pressing **OK**.

From this menu, you can:

- Adjust the Picture settings
- Adjust the Audio settings
- Setting the Sleep Timers
- Adjust the Network settings
- Adjust the Tuner settings
- Set up Closed Captioning
- Set up Devices
- Adjust TV settings
- Access the Guided Setup
- Access the User Manual

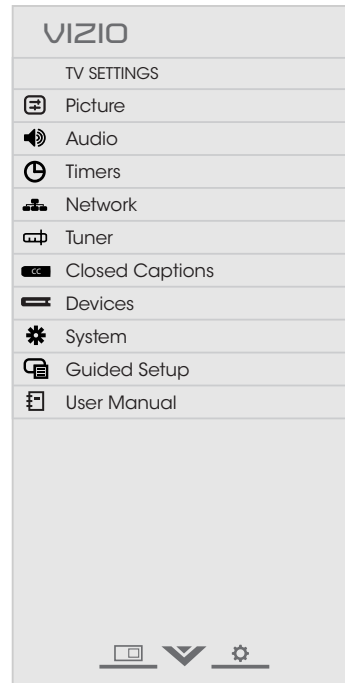

NAVIGATING THE ON-SCREEN MENU

To open the on-screen menu, press the **MENU** button on the remote.

Use the **Arrow** buttons to highlight a menu option, and press the **OK** button to select that option.



While navigating the on-screen menu, you can press the **BACK** button at any time to return to the previous menu screen. The **EXIT** button will close the on-screen menu.

CHANGING THE INPUT SOURCE

External devices such as DVD players, Blu-ray Players, and video game consoles can be connected to your TV. To use one of these devices with your TV, you must first change the input source using the Input menu.

To change the input source:

1. Press the **INPUT** button on the remote. The Input menu is displayed.
2. Use the **Up/Down Arrow** buttons or the **INPUT** button on the remote to highlight the input you wish to view and press **OK**. The selected input is displayed.

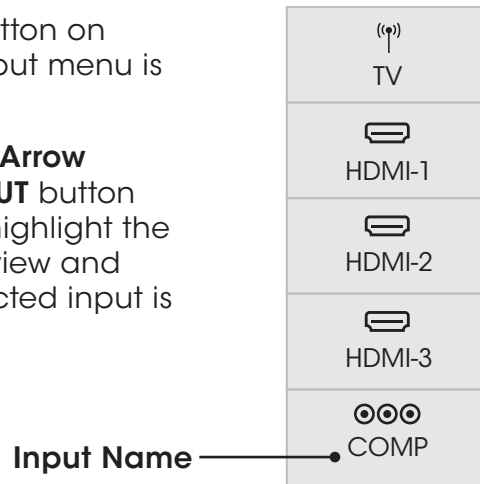

Note: Inputs may vary by TV.



You change the input names that appear on the Input menu to make your devices easy to recognize. See *Renaming Devices on the Input Menu* on page 47 for more information.

CHANGING THE SCREEN ASPECT RATIO

The TV can display images in five different modes: Normal, Stretch, Panoramic, Wide, and Zoom. Each mode displays the picture differently.

To change the screen aspect ratio:

1. Press the  button on the remote.
2. Use the **Arrow** buttons to highlight the aspect ratio you wish to view and press **OK**.

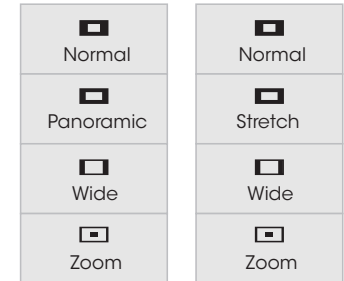

Note: Aspect ratio settings may vary by Input source.

- **Normal** preserves the content's original aspect ratio. Since the 4:3 aspect ratio is not large enough to fill the TV's screen, black bars are added to the left and right of the display image.
- **Stretch** expands the display image to fill the screen. Images may appear wider than intended. If you are watching widescreen (1.85:1 or 2.35:1) content, black bars will still appear on the top and bottom of the display image. **This option is only available when the TV is displaying a 720p/1080i source.**
- **Panoramic** expands the display image to fill the screen. Images may appear wider than intended. If you are watching widescreen (1.85:1 or 2.35:1) content, black bars will still appear on the top and bottom of the display image. **This option is only available when the TV is displaying a 480i/480p source.**
- **Wide** stretches a 4:3 aspect ratio picture to the edges of the screen. Since the picture is being stretched, the display image may appear distorted. If the program is already formatted for widescreen viewing (1.85:1 or 2.35:1), then black bars will appear on the top and bottom of the display image.
- **Zoom** expands images with black bars to fit the screen.

VIEWING VIDEO WITH THE MENU OPEN

When the on-screen menu opens, it covers the left-hand portion of the picture. The picture can be displayed in three different ways:

- **Full-sized and centered on the screen** - The left-hand portion of the picture covered by the menu.
- **Resized to fit** - The entire picture is visible in the space to the right of the menu.
- **Full-sized and aligned to the right edge of the menu** - The picture extends off of the right side of the screen.

To change the position of the picture while the on-screen menu is displayed:

1. Use the **Arrow** buttons on the remote to highlight  Resize Video.
2. Press **OK** to cycle through the three display methods.
3. Press the **Up Arrow** button on the remote to the menu.

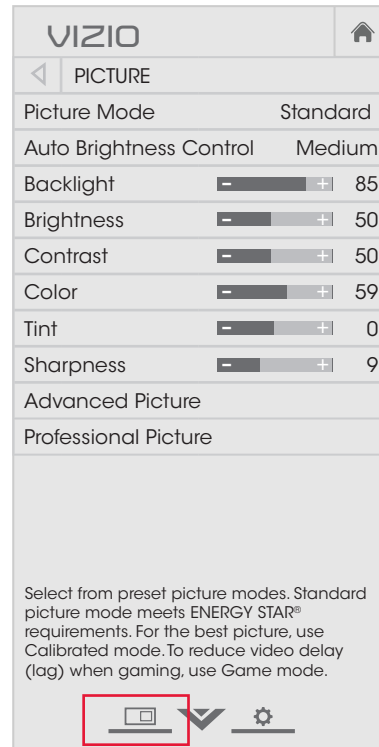

Full-sized and centered

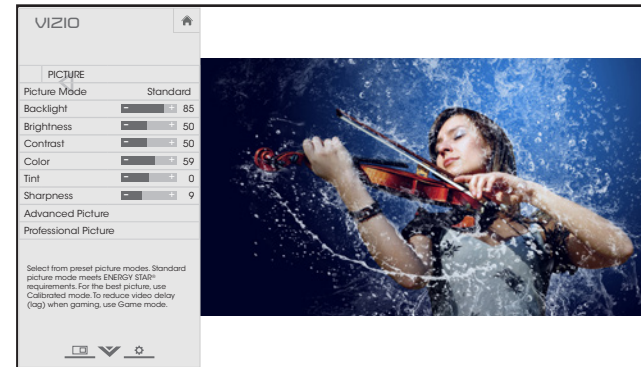

Resized to fit

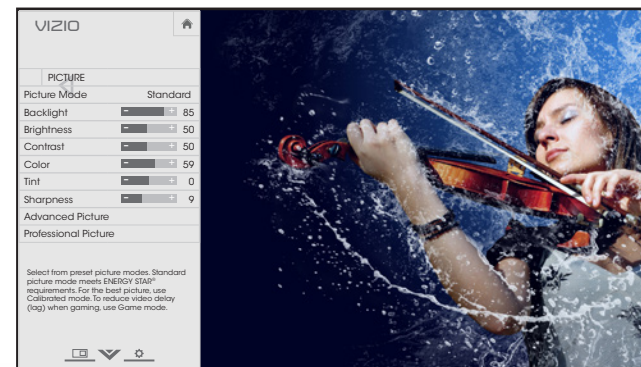

Full-sized and aligned to right of menu

ADJUSTING THE PICTURE SETTINGS

Your TV display can be adjusted to suit your preferences and viewing conditions.



Changes made while any preset picture mode is selected are automatically saved as a new custom picture mode (see *Custom Picture Modes on pages 27 through 29*). Automatically-created custom picture modes are given generic names, beginning with "Custom 1."

To adjust the picture settings:

1. Press the **MENU** button on the remote. The on-screen menu is displayed.
2. Use the **Arrow** buttons on the remote to highlight **Picture** and press **OK**. The PICTURE menu is displayed.
3. Use the **Arrow** buttons on the remote to highlight **Picture Mode**, then use the **Left/Right Arrow** buttons to change the picture mode:
 - **Standard mode** sets the various picture settings to values that meet ENERGY STAR® requirements.
 - **Calibrated mode** sets the picture settings to values perfect for watching TV in a brightly-lit room.
 - **Calibrated Dark mode** sets the picture settings to values perfect for watching TV in a dark room.

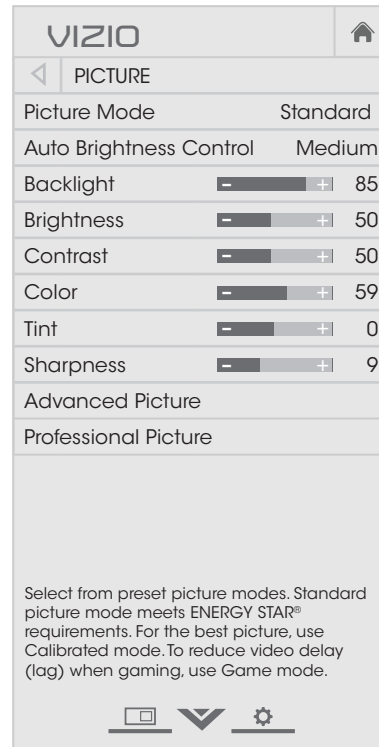

- **Vivid mode** sets the picture settings to values that produce a brighter, more vivid picture.
 - **Game mode** reduces throughput delays and optimizes the picture settings for displaying game console output.
 - **Computer mode** optimizes the picture settings for displaying computer output.
4. To manually change each of the picture settings, use the **Up/Down Arrow** buttons on the remote to highlight that picture setting, then use the **Left/Right Arrow** buttons to adjust the setting:
 - **Auto Brightness Control** - The auto brightness control detects the light levels in the room and automatically adjusts the backlight for the best picture. Select **Off**, **Low**, **Medium**, or **High**.
 - **Backlight** - Adjusts the LED brightness to affect the overall brilliance of the picture. Backlight cannot be adjusted when starting from some picture modes.
 - **Brightness** - Adjusts the black level of the picture. When this setting is too low, the picture may be too dark to distinguish details. When this setting is too high, the picture may appear faded or washed out.
 - **Contrast** - Adjusts the white level of the picture. When this setting is too low, the picture may appear dark. When this setting is too high, the picture may appear faded or washed out. If the setting is too high or too low, detail may be difficult to distinguish in dark or bright areas of the picture.
 - **Color** - Adjusts the intensity of the picture colors.
 - **Tint** - Adjusts the hue of the picture. This setting is useful in adjusting the flesh tones in the picture. If flesh appears too orange, reduce the level of color before adjusting tint.
 - **Sharpness** - Adjusts the edge sharpness of picture elements. It can be used to sharpen non-HD (high definition) content; however, it will not produce detail that does not otherwise exist.
 5. When you have finished adjusting the picture settings, press the **EXIT** button on the remote.

Adjusting the Advanced Picture Settings

To adjust the advanced picture settings:

1. From the PICTURE menu, use the **Arrow** buttons to highlight **Advanced Picture**, and then press **OK**, the ADVANCED PICTURE menu is displayed.

2. Use the **Arrow** buttons to highlight the setting you wish to adjust, then press the **Left/Right Arrow** buttons to change the setting:

- **Color Temperature** - Adjusts the 'warmness' and 'coolness' of the white areas of the picture. Select **Cool**, **Normal**, or **Computer**.
 - **Cool** produces a blue-hued picture.
 - **Computer** optimizes the picture for use as a PC monitor.
 - **Normal** is optimized for television viewing.
- **Black Detail** - Adjusts the average brightness of the picture to compensate for large areas of brightness. Select **Off**, **Low**, **Medium**, or **High**.
- **Smart Dimming** - Dynamically improves the contrast ratio of the picture by adjusting the backlight. The adjustment is controlled by the content on the screen. Select **On** or **Off**.
- **Reduce Signal Noise** - Diminishes artifacts in the image caused by the digitizing of image motion content. Select **Off**, **Low**, **Medium**, or **High**.
- **Reduce Block Noise** - Reduces pixelation and distortion for mpeg files. Select **Off**, **Low**, **Medium**, or **High**.

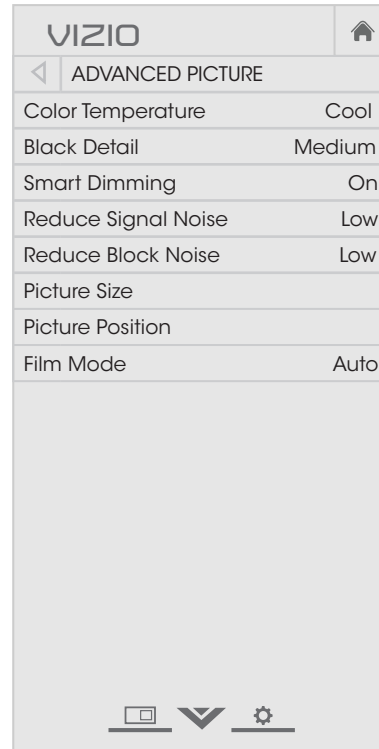

- **Picture Size** - Increase or decrease the vertical and horizontal size of the displayed picture. Use the **Left/Right Arrow** buttons to adjust the horizontal size of the displayed picture. Use the **Up/Down Arrow** buttons to adjust the vertical size of the displayed picture. Press the **OK** button when you are finished.
 - **Picture Position** - Adjust the vertical and horizontal positions of the picture to ensure the image is centered and completely fills the screen. Use the **Left/Right Arrow** buttons to adjust the horizontal position of the displayed picture. Use the **Up/Down Arrow** buttons to adjust the vertical position of the displayed picture. Press the **OK** button when you are finished.
 - **Film Mode** - Optimizes the picture for watching film. Select **Auto** or **Off**.
3. When you have finished adjusting the Advanced Picture Settings, press the **EXIT** button on the remote.

Adjusting the Professional Picture Settings

Professional Picture Settings allow you to make precise adjustments to the picture and to create picture modes to save groups of picture settings.



The Color Tuner, 11 Point White Balance, and test patterns allow technicians to manually calibrate the TV. Calibration requires specialized training, an input with precisely set colors, and a specialized light meter.

To adjust the professional picture settings:

- From the PICTURE menu, use the **Arrow** buttons to highlight **Professional Picture**, and then press **OK**. The PROFESSIONAL PICTURE menu is displayed.
-
- Use the **Arrow** buttons to highlight the setting you wish to adjust, then press **OK** to change the setting:
 - Color Tuner** - Adjust the HSB color and 11-point white balance, and display calibration test patterns.
 - Rename Picture Mode** - Rename a custom picture mode.
 - Create Picture Mode** - Create a custom picture mode.
 - Lock Picture Mode** - Prevent changes to custom picture modes.
 - Unlock Picture Mode** - Allow changes to custom picture modes.
 - Delete Picture Mode** - Delete a custom picture mode. Inputs assigned to that custom picture mode will be set to Calibrated picture mode.

Adjusting the Color Tuner Settings

The Color Tuner settings allow you to adjust the HSB color and 11 point white balance, turn color channels off for testing, and display color bar, flat, and ramp test patterns.

To adjust the HSB color settings:

- From the PROFESSIONAL PICTURE menu, use the **Arrow** buttons to highlight **Color Tuner**, and then press **OK**. The Color Tuner menu is displayed.

Color Tuner						
	Red	Green	Blue	Cyan	Magenta	Yellow
Hue	0	0	0	0	25	-14
Saturation	-1	5	-4	0	-2	0
Brightness	-24	0	-22	0	0	0
Offset	0	0	0			
Gain	0	0	0			

- Use the **Arrow** buttons on the remote to highlight the **Hue**, **Saturation**, **Brightness**, **Offset**, or **Gain** of the color you wish to adjust. Press the **OK** button.
- Use the **Left/Right Arrow** buttons to adjust the value. When you are finished press the **OK** button to save the setting.
- When you are finished adjusting the color tuner settings, press the **EXIT** button.

To turn color channels off and on:

1. From the PROFESSIONAL PICTURE menu, use the **Arrow** buttons to highlight **Color Tuner**, and then press **OK**. The Color Tuner menu is displayed.

Color Tuner						
	Red	Green	Blue	Cyan	Magenta	Yellow
Hue	0	0	0	0	25	-14
Saturation	-1	5	-4	0	-2	0
Brightness	-24	0	-22	0	0	0
Offset	0	0	0			
Gain	0	0	0			

2. Use the **Arrow** buttons on the remote to highlight **Red**, **Green**, or **Blue**.
3. Press the **OK** button to turn the color channel off or on. An X appears over a color channel that has been turned off.
4. Use the **Arrow** buttons to highlight another color channel to turn off or on. Only two color channels can be turned off at the same time.
5. When you are finished with the color channels, press the **EXIT** button.

To adjust the 11 Point White Balance settings:

1. From the Color Tuner menu, use the **Arrow** buttons to highlight **Color Tuner**, and then press the **Left/Right Arrow** buttons until the 11 Point White Balance menu is displayed.

11 Point White Balance				
	Gain	Red	Green	Blue
	5%	0	0	0

2. Use the **Arrow** buttons on the remote to highlight the **Gain** and **Color values** you wish to adjust. Press the **OK** button and use the **Left/Right Arrow** buttons to adjust the value. When you are finished press the **OK** button to save the setting.
3. When you are finished, press the **EXIT** button.

To show or hide the Color Bar Test Pattern:

1. From the Color Tuner menu, use the **Arrow** buttons to highlight **Color Tuner**, and then press the **Left/Right Arrow** buttons until the Color Bar Test Pattern menu is displayed.

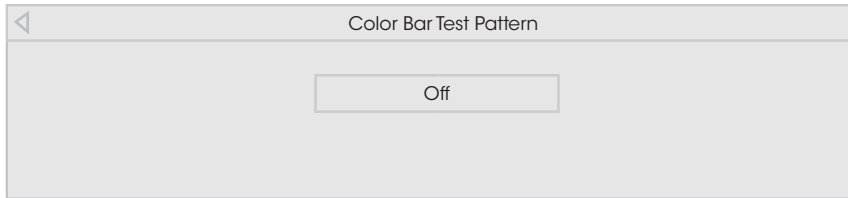

2. Use the **Arrow** buttons on the remote to highlight **Off**. Use the **Left/Right Arrow** buttons to highlight **On** to show the Color Bar.

—or—

To hide the Color Bar Test Pattern, use the **Left/Right Arrow** buttons to highlight **Off**.

3. When you are finished, press the **EXIT** button.

To show or hide the Flat Test Pattern:

1. From the Color Tuner menu, use the **Arrow** buttons to highlight **Color Tuner**, and then press the **Left/Right Arrow** buttons until the Flat Test Pattern menu is displayed.

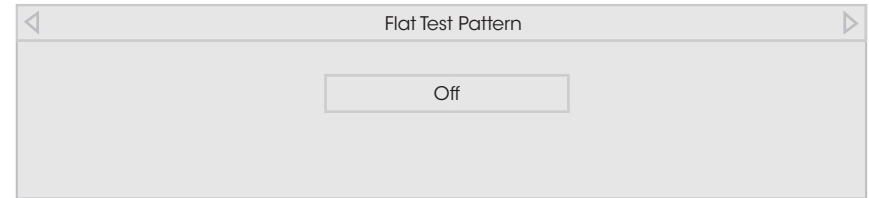

2. Use the **Arrow** buttons on the remote to highlight **Off**. Use the **Left/Right Arrow** buttons to select the percentage brightness for the flat test pattern. Selecting a percentage immediately shows the flat pattern at that brightness.

—or—

To disable the Flat Test Pattern, use the **Left/Right Arrow** buttons to highlight **Off**.

3. When you are finished, press the **EXIT** button.

To show or hide the Ramp Test Pattern:

1. From the Color Tuner menu, use the **Arrow** buttons to highlight **Color Tuner**, and then press the **Left/Right Arrow** buttons until the Ramp Test Pattern menu is displayed.

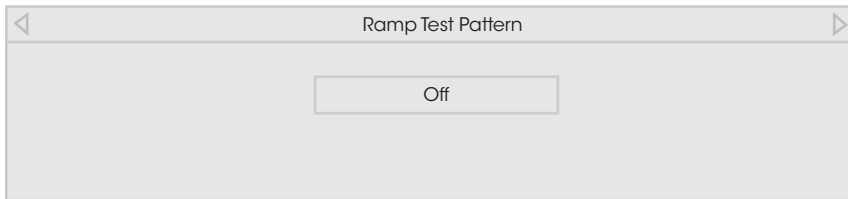

2. Use the **Arrow** buttons on the remote to highlight **Off**. Use the **Left/Right Arrow** buttons to select the color for the ramp test pattern. Selecting a color immediately shows that color ramp.

—or—

To hide the Ramp Test Pattern, use the **Left/Right Arrow** buttons to highlight **Off**.

3. When you are finished, press the **EXIT** button.

Creating a Custom Picture Mode

Custom picture modes allow you to save a group of custom settings for various viewing conditions and video sources.

- Custom picture modes can be created manually.
- A new custom picture mode is created automatically whenever picture settings are changed while in any preset picture mode.



A custom picture mode only applies to the input (HDMI-1, COMP, etc.) in use when it was created. Each input can have up to eight custom picture modes.

To create a custom picture mode manually:

1. From the PROFESSIONAL PICTURE menu, use the **Arrow** buttons to highlight **Create Picture Mode**, and then press **OK**. The CREATE PICTURE MODE menu is displayed.
2. Use the **Arrow** buttons to enter a name for your custom picture mode using the on-screen keyboard.
3. Highlight **Done** and press **OK**.
4. Make any desired changes to the picture settings.
5. Press the **EXIT** button to exit the menu screens.

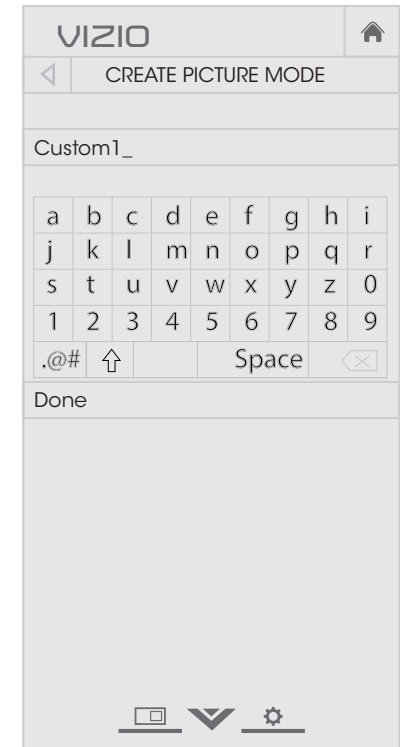

Renaming a Custom Picture Mode

Automatically-created custom picture modes are given generic names, beginning with "Custom 1", but you can rename custom picture modes to make them easy to remember.

To rename a custom picture mode:

1. Set the Picture Mode to an existing custom setting. See *Adjusting the Picture Settings* on page 22.
2. From the PROFESSIONAL PICTURE menu, use the **Arrow** buttons to highlight **Rename Picture Mode**, and then press **OK**. The RENAME PICTURE MODE menu is displayed.
3. Use the **Arrow** buttons to enter a custom name using the on-screen keyboard.
4. Highlight **Done** and press **OK**.
5. Press the **EXIT** button to exit the menu screens.

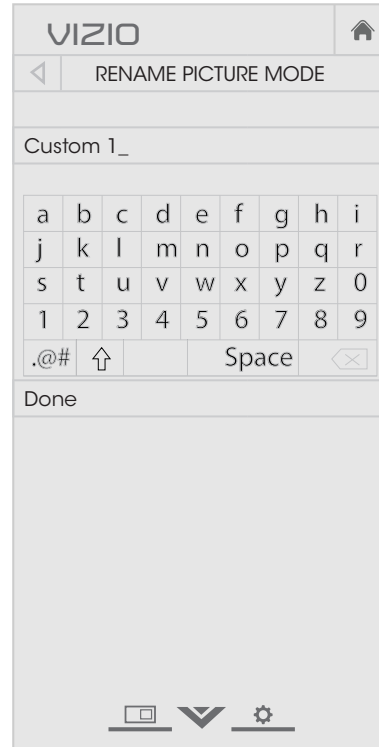

Locking a Custom Picture Mode

Custom picture modes can be locked with a unique PIN to prevent accidental changes to their settings.

To lock all custom picture modes:

1. From the PROFESSIONAL PICTURE menu, use the **Arrow** buttons to highlight **Lock Picture Mode**, and then press **OK**. The LOCK PICTURE MODE menu is displayed.
2. Use the **Number Pad** on your remote to enter a unique 4-digit PIN.
3. Highlight **Save** and press **OK**.
4. Press the **EXIT** button to exit the menu screens.

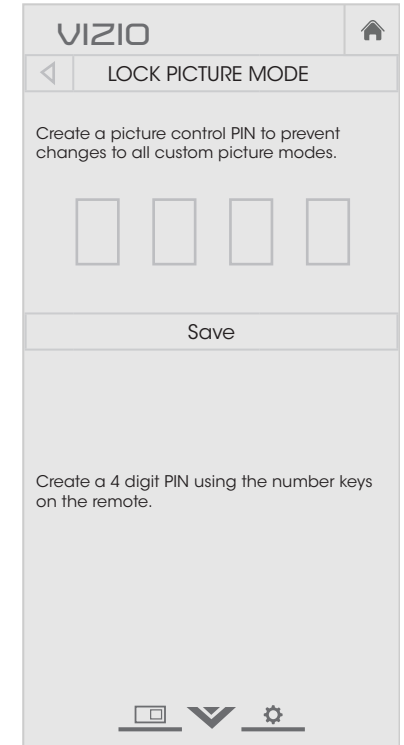

To unlock all custom picture modes:

1. From the PROFESSIONAL PICTURE menu, use the **Arrow** buttons to highlight **Unlock Picture Mode**, and then press **OK**. The UNLOCK PICTURE MODE menu is displayed.
2. Use the **Number Pad** on your remote to enter your 4-digit PIN.
3. Make any desired changes to the picture modes.
4. Relock the picture modes, if desired. You must create a new 4-digit PIN.
5. Press the **EXIT** button to exit the menu screens.

Deleting a Custom Picture Mode

Custom picture modes that are no longer needed can be deleted.



Inputs assigned to a deleted custom picture mode become assigned to the *Calibrated* picture mode.

To delete a custom picture mode:

1. From the PROFESSIONAL PICTURE menu, use the **Arrow** buttons to highlight **Delete Picture Mode**, and then press **OK**. The DELETE PICTURE MODE window is displayed.
2. Use the **Left/Right** Arrow buttons to highlight **Delete** and press **OK**.
3. Press the **EXIT** button to exit the menu screens.

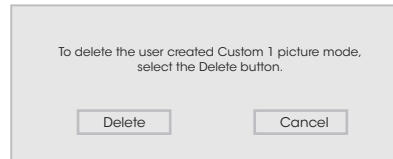

ADJUSTING THE AUDIO SETTINGS

To adjust the audio settings:

1. Press the **MENU** button on the remote. The on-screen menu is displayed.
2. Use the **Arrow** buttons on the remote to highlight **Audio** and press **OK**. The AUDIO menu is displayed.
3. Use the **Arrow** buttons to highlight the setting you wish to adjust, then press **Left/Right Arrow** buttons to change the setting:

VIZIO		⌂
AUDIO		
TV Speakers		On
Surround Sound		On
Volume Leveling		On
Balance	[-] [] [+]	0
Lip Sync	[-] [] [+]	0
Volume Control		TV
Digital Audio Out		PCM
Analog Audio Out		Fixed
Equalizer Settings		
Delete Audio Mode		
Audio Device Setup		

- **TV Speakers** - Turns the built-in speakers on or off.



When an external audio device (such as a VIZIO sound bar) is set up, TV Speakers is automatically set to **Off** and Volume Control to **External**.

To use the TV speakers, set TV Speakers to **On** and Volume Control to **TV**.



When the TV speakers are set to **On**, DTS signals cannot be passed through digital audio outputs.

- **Surround Sound** - Surround sound uses DTS TruSurround™ to deliver an immersive surround sound experience from the TV's internal speakers. TruSurround completes the entertainment experience by providing deep, rich bass and by delivering crisp details and clear, intelligible dialog. Select **On** or **Off**.
- **Volume Leveling** - Volume leveling uses DTS TruVolume™ to maintain consistent volume levels during transitions

between program content, AV formats, and input sources. Select **On** or **Off**. In a few cases, volume leveling may artificially suppress volume increases, making it difficult to hear dialog or flattening sudden noises. If this occurs, turn volume leveling off.

- **Balance** - Adjusts the loudness of the audio output from the left and right speakers.
- **Lip Sync** - Adjusts the synchronization between the display image and the accompanying audio track.
- **Volume Control** - Sets the VIZIO TV remote to control either the volume level of the TV or an external audio device. Select **TV** or **External**.
- **Digital Audio Out** - Changes the type of processing for digital audio out and HDMI ARC output when connected to a home theater audio system. Select **PCM** or **Bitstream**.



You must select **Bitstream** for audio with more than two channels (3.0, 5.0, or 5.1, for example).

- **Analog Audio Out** - Sets the volume control properties for the RCA connector when connected to a home theater audio system. Select **Variable** if you are controlling the volume with the TV's volume controls, or select **Fixed** if an external audio device (sound bar or AV receiver) will control the volume.
- **Equalizer Settings** - Adjusts the boost or attenuation of different frequencies using either preset or custom settings. See *Changing the Equalizer Settings* on page 32.
- **Delete Audio Mode** - Deletes a custom audio mode created using the Equalizer Settings. See *Deleting the Custom Audio Mode* on page 33.
- **Audio Device Setup** - Set up an audio device so that the TV remote can be used to change the volume. See *Setting up an Audio Device* on page 31.

4. When you have finished adjusting the audio settings, press the **EXIT** button on the remote.

Setting up an Audio Device

The VIZIO remote control can be set up to control the volume levels of an audio device. Only one audio device can be added.

To set up an audio device with the remote:

1. From the AUDIO menu, use the **Arrow** and **OK** buttons to select **Audio Device Setup**. The DEVICES SETUP menu displays.
2. Use the **Arrow** buttons to highlight **Select Device**. Use the **Left/Right Arrow** buttons to select the type of device you are connecting.
3. Use the **Arrow** buttons to highlight **Select Brand** and press **OK**. The SELECT BRAND menu displays.
4. Use the on-screen keyboard to enter the brand name of your device. Select the brand name from the dropdown menu. Highlight **OK** and press **OK**.

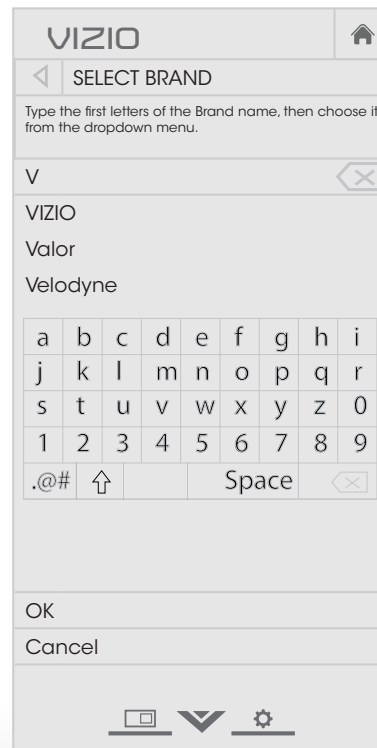

5. Use the Arrow buttons on the remote to highlight **Select Model** and press **OK**. The SELECT MODEL menu displays.
6. Use the on-screen keyboard to enter the model of your device. Select the model from the dropdown menu. Highlight **OK** and press **OK**.
7. Use the **Arrow** buttons on the remote to highlight **Confirm Remote Connection** and press **OK**. The CONFIRM REMOTE CONNECTION menu displays.

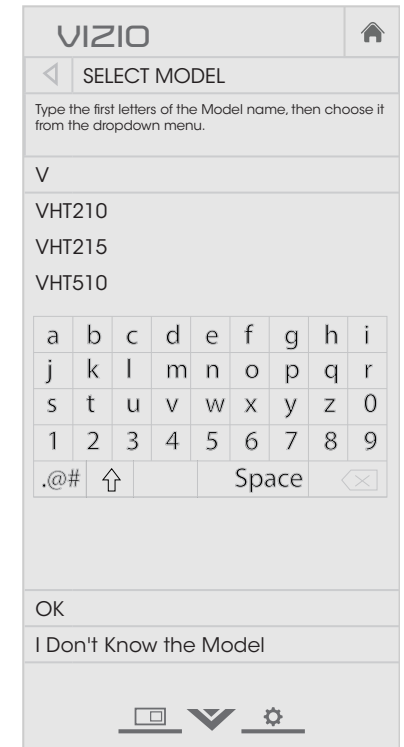

8. Point the remote at your device and press the Volume Up or Down button.
 - If the volume changed, highlight **Volume Has Changed** and press **OK**.
 - If the volume has not changed, highlight **Try the next Code** and repeat step 8.

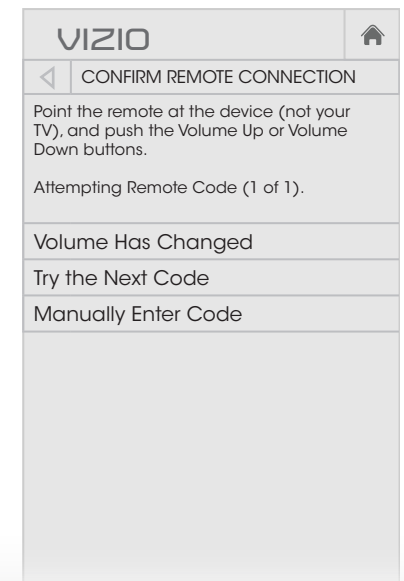

9. If the volume does not change, you will need to manually enter a remote control code from your device's manufacturer.

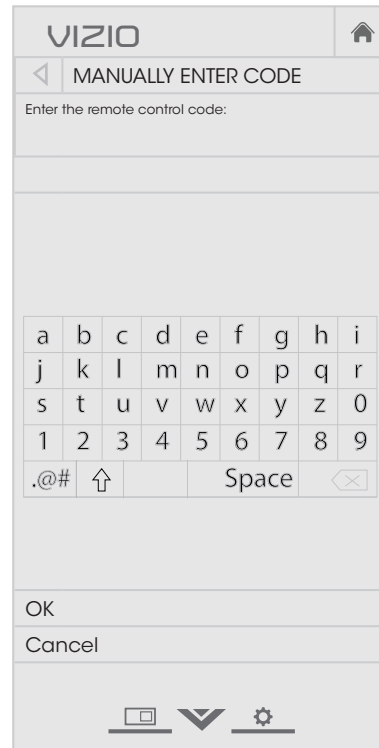

1. When you have the remote control code, highlight **Manually Enter Code** and press **OK**.
2. Use the number pad on the remote control to enter the code. Highlight **OK** and press **OK**.
3. Follow the on-screen instructions to complete the pairing. If you still cannot pair your audio device, contact your device's manufacturer.

Changing the Equalizer Settings

The graphic equalizer has several pre-set modes and allows you to create one custom mode.

To select a pre-set audio mode:

1. Press the **MENU** button on the remote. The on-screen menu is displayed.
2. Use the **Arrow** buttons on the remote to highlight **Audio** and press **OK**. The AUDIO menu is displayed.
3. Use the **Arrow** buttons to highlight **Equalizer Settings** and press **OK**. The Audio Mode and equalizer settings screen appears.
4. Use the **Left** and **Right Arrow** buttons to select an audio mode. The equalizer bars change to reflect the mode.
5. Press the **EXIT** button on the remote.

To create, modify, or replace the single custom equalizer setting:

1. Press the **MENU** button on the remote. The on-screen menu is displayed.
2. Use the **Arrow** buttons on the remote to highlight **Audio** and press **OK**. The AUDIO menu is displayed.
3. Use the **Arrow** buttons to highlight **Equalizer Settings** and press **OK**. The Audio Mode and equalizer settings screen appears.
4. Use the **Left** and **Right Arrow** buttons to select any audio mode as a starting point.
5. Use the **Arrow** buttons to highlight a frequency and then press **OK**.
6. Use the **Up** and **Down Arrow** buttons to adjust the boost (up) and attenuation (down) for the frequency.
7. Use the **Left** and **Right Arrow** buttons to select another frequency, if desired, and adjust it.
8. Press the **EXIT** button on the remote.

Deleting the Custom Audio Mode

To delete the custom audio mode that has been created:

1. Press the **MENU** button on the remote. The on-screen menu is displayed.
2. Use the **Arrow** buttons on the remote to highlight **Audio** and press **OK**. The AUDIO menu is displayed.
3. Use the **Arrow** buttons to highlight **Delete Audio Mode** and press **OK**. The TV displays, "To delete the user created custom audio mode, select the Delete button."
4. Highlight **Delete** and press **OK**.
5. Press the **EXIT** button on the remote.

SETTING TIMERS

Setting the Sleep Timer

When activated, the TV's sleep timer will turn the TV off after a set period of time.

1. Press the **MENU** button on the remote. The on-screen menu is displayed.
2. Use the **Arrow** buttons on the remote to highlight **Timers** and press **OK**. The TIMERS menu is displayed.
3. Use the **Left/Right Arrow** buttons on the remote to highlight the period of time after which you want the TV to go to sleep: **30, 60, 90, 120,** or **180 minutes**. If you don't want the sleep timer to activate, change the setting to **Off**.
4. When you have finished setting the sleep timer, press the **EXIT** button on the remote.

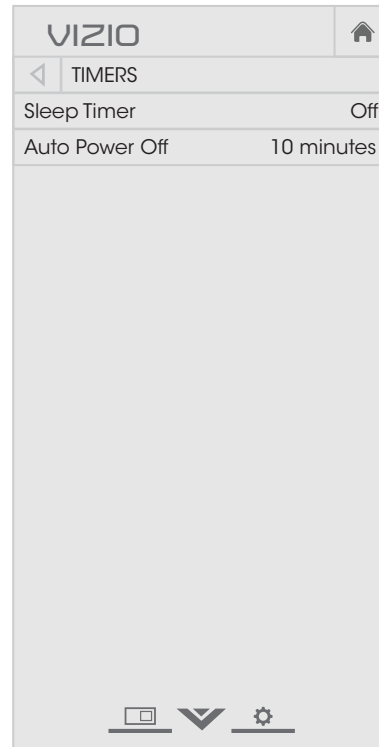

Setting the Auto Power Off Feature

To help save energy, your TV is set by default to turn off after 10 minutes without a video or audio signal. This feature can be deactivated.

To set the Auto Power Off feature:

1. From the TIMERS menu, use the **Up/Down Arrow** buttons on the remote to highlight **Auto Power Off**.
2. Use the **Left/Right Arrow** buttons on the remote to change whether the TV will turn off. If you don't want the TV to turn off when there is no signal, change the setting to **Off**. Otherwise, select **10 minutes**.
3. When you have finished setting the auto power off time, press the **EXIT** button on the remote.

USING THE NETWORK CONNECTION MENU

Your TV is Internet-ready, featuring both an Ethernet port and built-in high-speed Wireless-N.

Connecting to a Wireless Network

To connect to a wireless network whose network name (SSID) is being broadcast:



If your TV is connected to a network with an Ethernet cable, you will not see the wireless network connection menu. You must disconnect the Ethernet cable to set up a wireless network connection.

1. Press the **MENU** button on the remote. The on-screen menu is displayed.
2. Use the **Arrow** buttons on the remote to highlight **Network** and press **OK**. The NETWORK menu is displayed.
3. If you do not see your wireless network displayed, highlight **More Access Points** and press **OK**. The MORE ACCESS POINTS menu, which is a list of available wireless networks, is displayed.
4. Highlight the name of your wireless network (this is the network's SSID) and press **OK**.
5. Using the on-screen keyboard, enter your network's password, then highlight **Connect** and press **OK**.
6. Press the **EXIT** button on the remote.

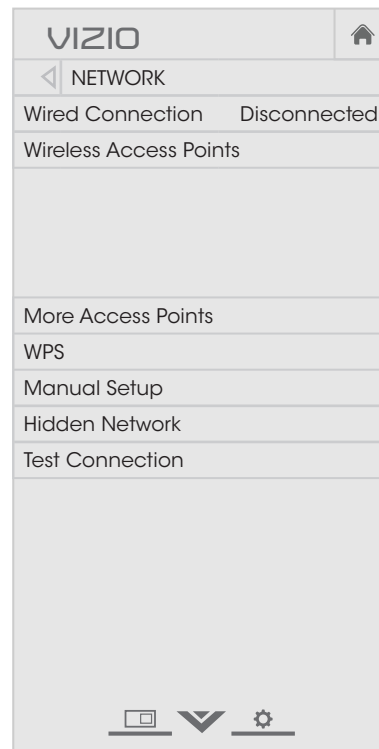

Changing the Manual Setup Settings

Advanced users can fine-tune the network settings using the Manual Setup feature.

To change advanced network settings:

1. From the NETWORK menu, highlight **Manual Setup** and press **OK**. The MANUAL SETUP menu is displayed.
2. To change the settings manually, use the **Arrow** buttons on the remote to highlight **DHCP** and then use the **Left/Right Arrow** buttons to change the setting to **Off**.
3. Use the **Arrow** and **OK** buttons to adjust each setting:
 - **IP Address** - The IP address assigned to the TV.
 - **Subnet Mask** - The subnet mask.
 - **Default Gateway** - Your network's default gateway address.
 - **Pref. DNS Server** - Your preferred domain name server address.
 - **Alt. DNS Server** - Your alternate domain name server address.
4. Use the **Arrow** buttons on the remote to highlight **Save** and press **OK**.
5. Press the **EXIT** button on the remote.

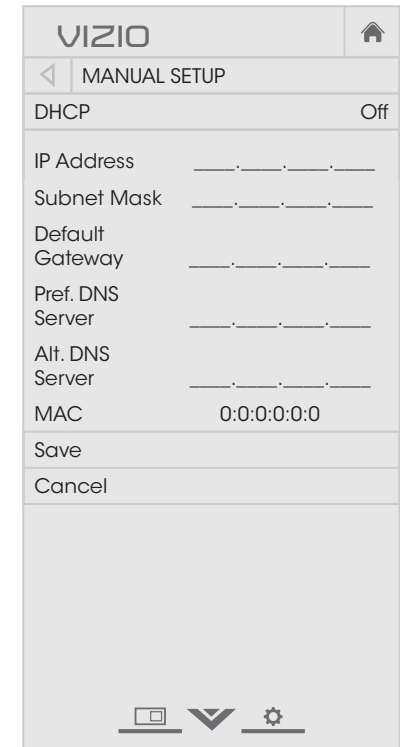

Finding MAC Addresses for Network Setup

The security settings on your router may require you to enter the TV's MAC address in the router's settings.

To find the TV's MAC address:

1. From the NETWORK menu, highlight **Manual Setup** and press **OK**. The MANUAL SETUP menu is displayed.
2. Find the MAC address for the TV at the bottom of the list. The MAC addresses for the connections in use are displayed:
 - **RJ45 MAC** - The Ethernet or RJ45 MAC address may be needed to set up your network when you have connected the TV to your network with an Ethernet (Cat 5) cable.
 - **Wireless MAC** - The Wireless (WiFi) MAC address may be needed to connect your TV to your network with WiFi.

Connecting to a Hidden Network

To connect to a wireless network whose network name (SSID) is not being broadcast:

1. From the NETWORK menu, highlight **Hidden Network** and press **OK**. The ENTER ACCESS POINT NAME screen is displayed.
2. Using the on-screen keyboard, enter your network's name (SSID), then highlight **Connect** and press **OK**.
3. Using the on-screen keyboard, enter your network's password, then highlight **Connect** and press **OK**.
4. Press the **EXIT** button on the remote.



Testing Your Network Connection

To test your network connection:

1. From the NETWORK menu, highlight **Test Connection** and press **OK**.
2. The TEST CONNECTION screen displays the connection method, network name, signal strength, and download speed of your network connection.
3. Press the **EXIT** button on the remote.

SETTING UP THE TUNER

You can use the TV's Tuner menu to:

- Select a Tuner Input
- Perform an Auto Channel Scan
- Perform a Partial Channel Scan
- Manually Add Channels
- Select channels to skip
- Select Analog MTS modes
- Select Digital Languages

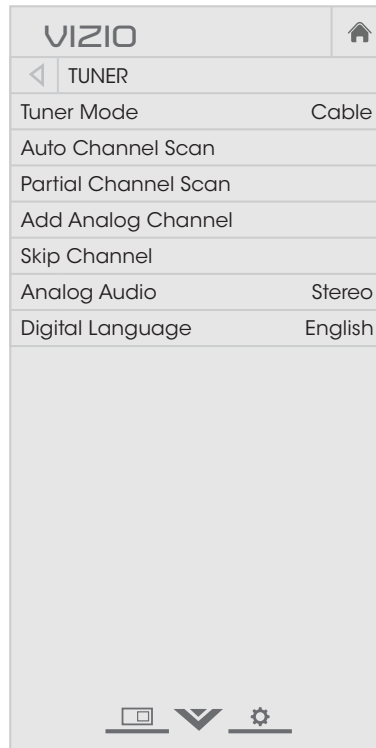

Selecting a Tuner Input

Select the type of tuner input you will be using. You can select either Antenna (Over-the-air) or Cable (Out-of-the-wall) connections.

1. From the TUNER menu, highlight **Tuner Mode** and press **OK**. The TUNER MODE menu displays.
2. Highlight **Antenna** or **Cable** and press **OK**. Press **EXIT**.

Scanning for Channels

The TV may need to scan for channels before it can display programs and their associated information. A channel scan is required for free over-the-air channels (using an antenna) and cable channels from an out-of-the-wall connection (without a cable box). Moving the TV to an area with different channels requires the TV to scan for channels again.

To perform an Auto Channel Scan:

1. From the TUNER menu, highlight **Auto Channel Scan**, and press **OK**. The auto channel scan begins.
2. Wait until the channel scan is 100% complete. Highlight **Done** and press **OK**.
3. Press the **EXIT** button on the remote.

If the channel scan is cancelled, the channels that were already discovered are retained. A new channel scan will clear all channels.

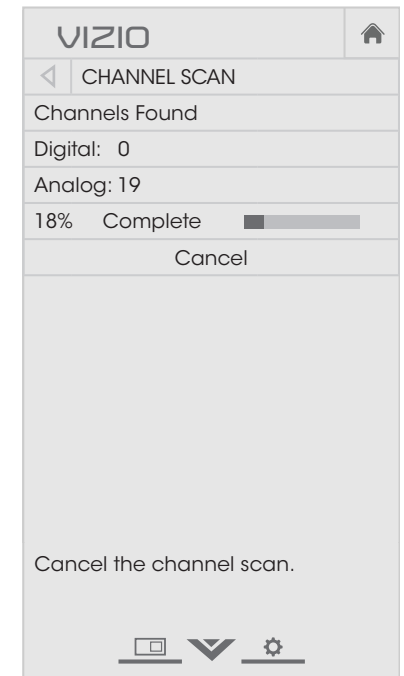

Adding New Channels

Occasionally, you may need to add a new range of channels or add a new analog channel. You can do this by using the Partial Channel Scan and Add Analog Channel options. This is quicker than scanning all possible channels.

To add a range of new channels:

1. From the TUNER menu, highlight **Partial Channel Scan**, and press **OK**. The PARTIAL CHANNEL SCAN menu is displayed.
2. Highlight **Scan Mode** and select the type of channel you are adding: **Analog**, **Digital**, or **Analog/Digital**.
3. Highlight **From Channel** and enter the channel where you want to begin the scan. (Use the **Left Arrow** button to backspace. Use the **Number Pad** on the remote to enter the channel.)
4. Highlight **To Channel** and enter the channel where you want to end the scan. (Use the **Left Arrow** button to backspace. Use the **Number Pad** on the remote to enter the channel.)
5. Highlight **Start** and press **OK**. The partial channel search begins.
6. Wait until the partial channel search is 100% complete. Highlight **Done** and press **OK**.
7. Press the **EXIT** button on the remote.

To add a single new analog channel:

1. From the TUNER menu, highlight **Add Analog Channel** and press **OK**. The ADD ANALOG CHANNEL menu is displayed.
2. Highlight **Enter Channel #** and use the **Number Pad** on the remote to enter the number of the channel you are adding.
3. Highlight **Add Channel** and press **OK**. The TV scans for the channel.
4. When the TV is done scanning for the channel, press the **EXIT** button on the remote.

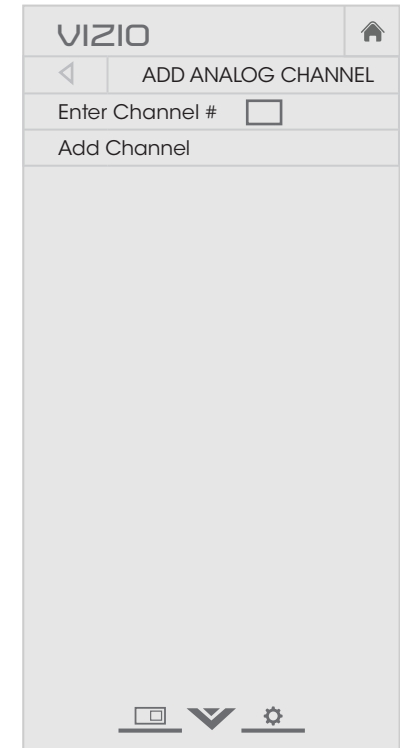

Skipping Channels

After a channel scan is completed, you may find that some channels are too weak to watch comfortably. There may also be some channels you do not want to view. You can remove these channels from the TV's memory with the Skip Channel feature.



Channels that have been removed with the Skip Channel feature can still be viewed if the channel is entered using the Number Pad. If you wish to completely block a channel from being viewed, use the parental controls. See *Locking and Unlocking Channels* on page 49.

To remove a channel:

1. From the TUNER menu, highlight **Skip Channel**, and press **OK**. The SKIP CHANNEL menu is displayed.
2. For each channel you wish to remove, use the **Up/Down Arrow** buttons on the remote to highlight the channel and press **OK**. A ✓ appears to the right of each channel you select.
3. When you have selected all of the channels you wish to remove, press the **EXIT** button on the remote.

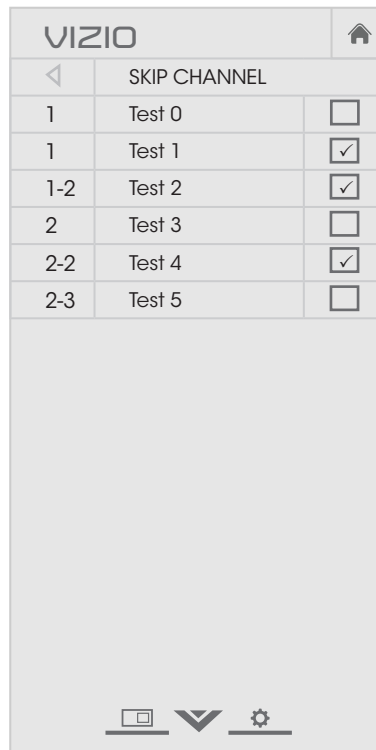

LISTENING TO ALTERNATE AUDIO

Changing the Analog Audio Language

Some analog over-the-air (free) and cable channels broadcast programs in more than one language. The TV's Analog Audio feature allows you to listen to audio in an alternate language using Secondary Audio Programming (SAP).



Not all programs are broadcast in SAP. The Analog Audio Language feature only works when the program being viewed is being broadcast with Secondary Audio Programming.

To use the Analog Audio feature:

1. From the TUNER menu, highlight **Analog Audio** and press **OK**. The ANALOG AUDIO menu is displayed.
2. Select **Stereo**, **SAP** (secondary audio programming), or **Mono**. Press **OK**.
3. Press the **EXIT** button on the remote.

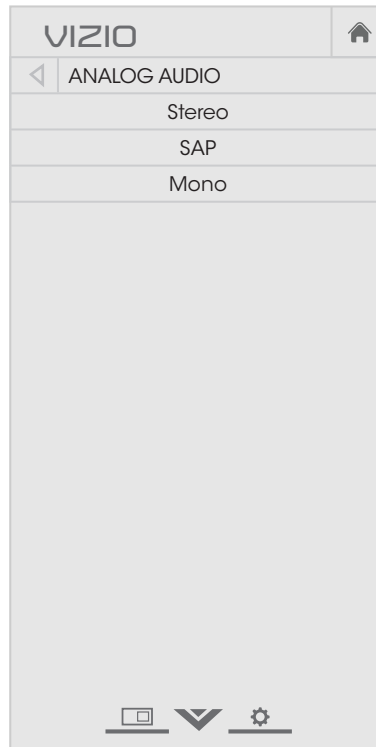

Changing the Digital Audio Language

Some digital over-the-air (free), cable, and satellite channels broadcast programs in more than one language. The TV's Digital Audio feature allows you to listen to audio in alternate languages.



Not all programs are broadcast in alternate languages. The Digital Audio Language feature only works when the program being viewed is being broadcast in the language you select.

1. From the TUNER menu, highlight **Digital Language** and press **OK**. The DIGITAL LANGUAGE menu is displayed.
2. Select your preferred language: **English**, **Español**, or **Français**. Press **OK**.
3. Press the **EXIT** button on the remote.

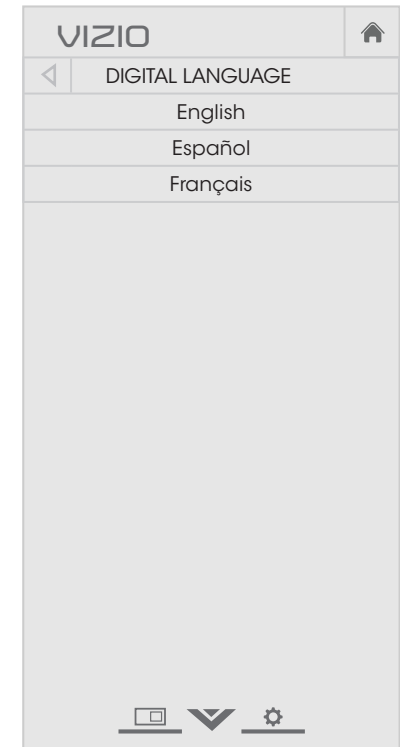

SETTING UP CLOSED CAPTIONING

Your TV can display closed captions for programs that include them. Closed captions display a transcription of a program's dialogue.



If the program you are viewing is not being broadcast with closed captions, the TV will not display them.



The Closed Captions menu does not appear when an HDMI input is selected.

To activate or deactivate closed captions:

1. Press the **MENU** button on the remote. The on-screen menu is displayed.
2. Use the **Arrow** buttons on the remote to highlight **Closed Captions** and press **OK**. The CLOSED CAPTIONS menu is displayed.
3. Use the **Arrow** buttons on the remote to highlight **Closed Captions** and then use the **Left/Right Arrow** buttons to select **On** or **Off**.
4. Use the **Arrow** buttons on the remote to highlight either **Analog** or **Digital Closed Captions**.
5. Use the **Left/Right Arrow** buttons on the remote to select the caption channel you wish to display, then press **EXIT**.

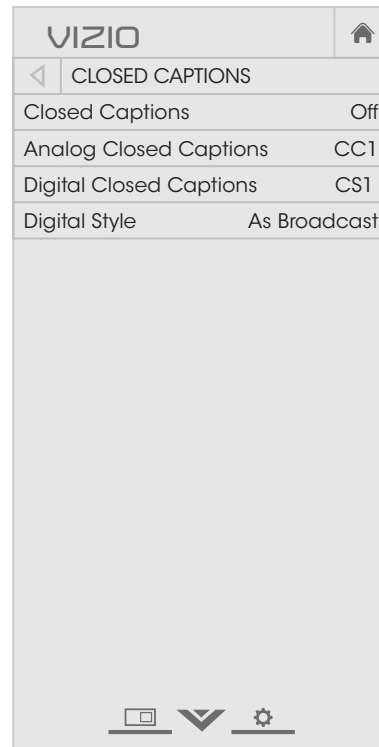

Changing the Appearance of Digital Closed Captions

Digital closed captions can be displayed according to your preference. See the diagram on the next page for an explanation of the parts of the closed caption area.

To change the appearance of digital closed captions:

1. From the CLOSED CAPTIONS menu, use the **Arrow** buttons to highlight **Digital Style** and press **OK**.
2. Use the **Left/Right Arrow** buttons on the remote to select **Custom**. The DIGITAL STYLE menu appears as shown.
3. Use the **Up/Down Arrow** buttons on the remote to highlight the setting you wish to change, then use the **Left/Right Arrow** buttons to change the setting:

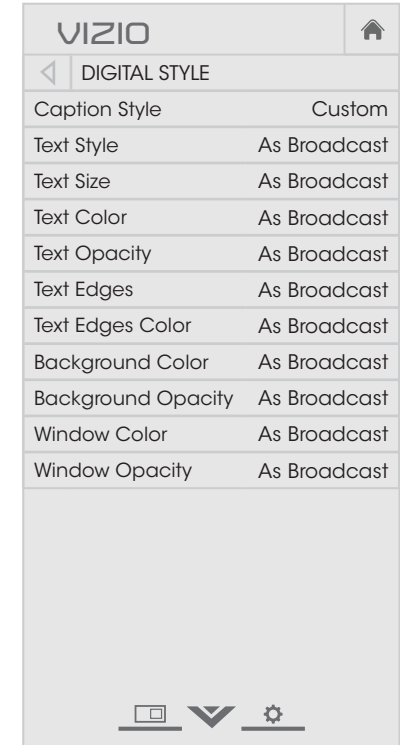

- **Caption Style** - Choose **As Broadcast** to keep default settings or **Custom** to manually change each setting.
- **Text Style** - Change the font used for the closed captioning text.
- **Text Size** - Make the text larger or smaller.
- **Text Color** - Change the color of the text.
- **Text Opacity** - Change the transparency of the text.
- **Text Edges** - Change the effects at the edges of the text, such as raising the edges or adding drop shadows.
- **Text Edges Color** - Change the color of the text edge effects.

- **Background Color** - Change the color of the background directly behind the text.
 - **Background Opacity** - Change the transparency of the background directly behind the text.
 - **Window Color** - Change the color of the closed captioning box.
 - **Window Opacity** - Change the opacity of the closed captioning box.
4. When you are satisfied with the appearance of the closed captions, press the **EXIT** button on the remote.

Typical choices include:

- Opaque background, transparent window—Only a strip of background appears behind the text, expanding as the text appears. This is the typical "As Broadcast" mode.
- Opaque background and window in the same color—When text appears, the entire line fills with color at once.

In the example below, the closed caption text is green, the background is black, and the window is red.

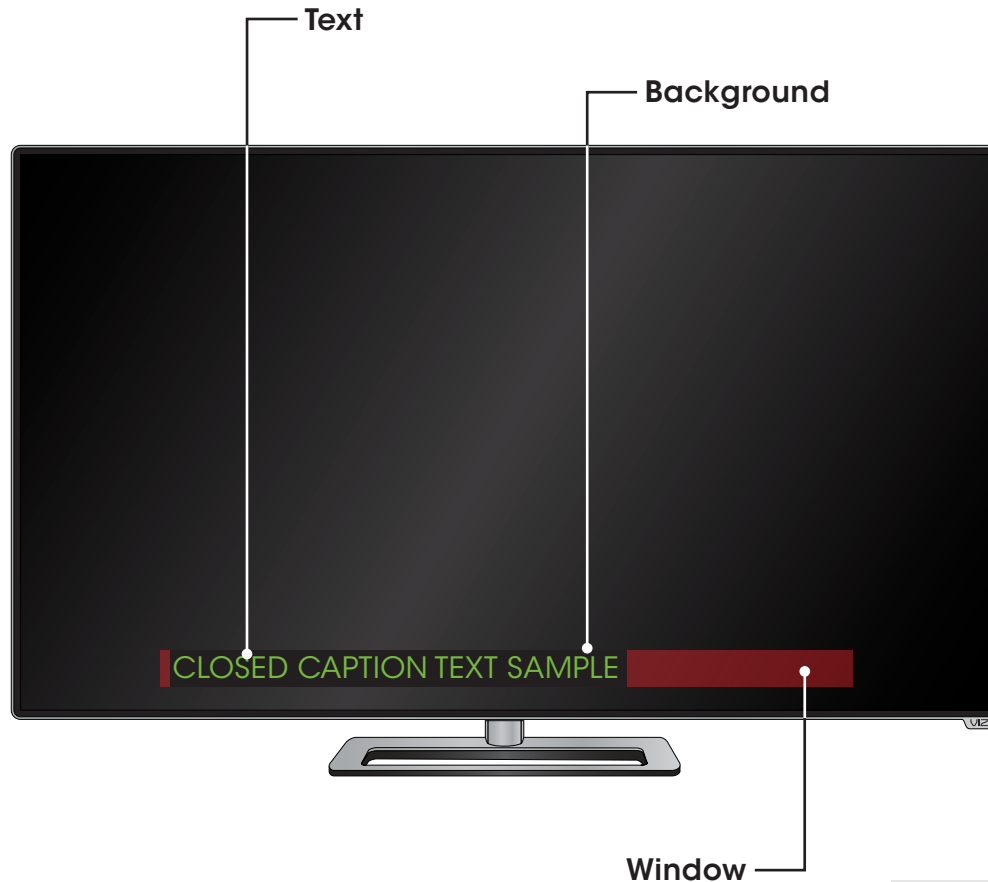

CLOSED CAPTIONS SCREEN LAYOUT

SETTING UP DEVICES

The VIZIO remote control doubles as a universal remote where you can power on/off and control various devices (Blu-ray players, Cable box, VCR, etc.) connected through the HDMI and component inputs.

To view the devices set up with the remote control:

1. Press the **MENU** button on the remote. The on-screen menu is displayed.
2. Use the **Up/Down** Arrow buttons on the remote to highlight **Devices** and press **OK**. The DEVICES menu is displayed.
3. Use the **Up/Down** Arrow buttons to highlight the device you wish to view and press **OK**. The device information page is displayed.

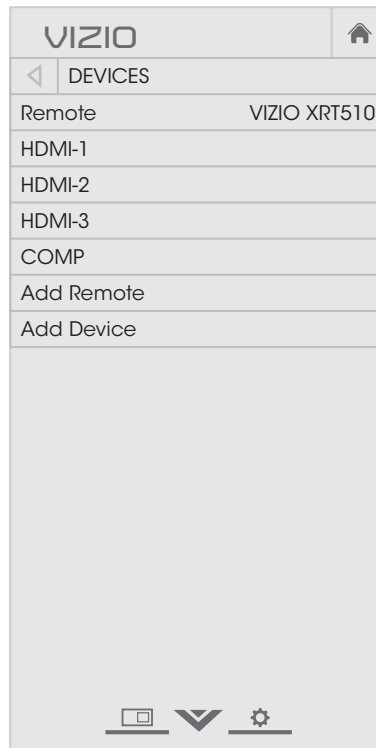

From the device information page, you can name and unpair the device.



Pairing a VIZIO Remote Control

The VIZIO TV remote control (XRT510) has already been paired during first-time setup. If you unpaired your remote, you can pair it again using the devices menu.

To pair the remote control:

1. From the DEVICES menu, use the **Arrow** buttons on the remote to highlight **Add Remote** and press **OK**.
 2. **Press and hold** the **Record**  and **Green**  buttons for **5 seconds**.
- When the message "Remote is ready to pair. Select Pair Remote." is displayed, use the **Up/Down Arrow** buttons on the remote to select **Pair Remote** and press **OK**. The remote is paired.
3. Press the **EXIT** button on the remote control.

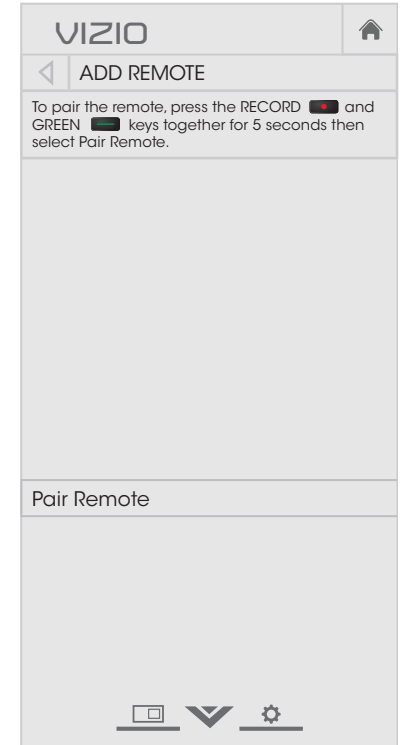

Pairing a New Device

You will need to pair your device with the VIZIO TV remote control before you can power on/off and control it. Only one audio device can be added.



The VIZIO TV remote control must be paired with the TV before you can pair new devices.

To pair a device with your VIZIO TV remote:

1. From the DEVICES menu, use the **Arrow** buttons on the remote to highlight **Add Device** and press **OK**. The DEVICE SETUP menu is displayed.
2. Use the **Arrow** buttons on the remote to highlight **Select Device** and then use the **Left/Right Arrow** buttons to select the type of device you want to add.
3. Use the **Arrow** buttons on the remote to highlight **Input Source** and then use the **Left/Right Arrow** buttons to select the input that the device is connected to.

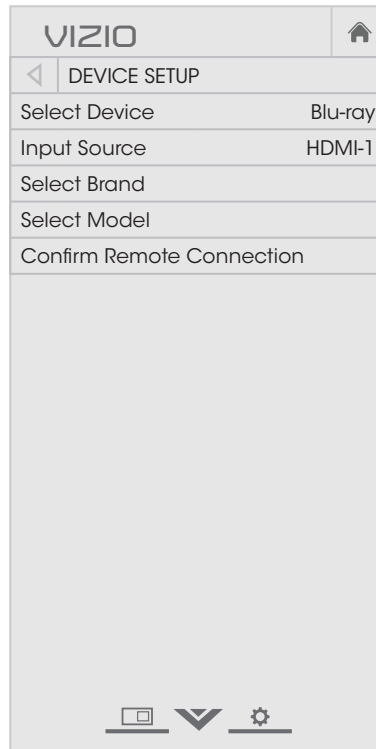

4. Use the **Arrow** buttons on the remote to highlight **Select Brand** and press **OK**. The SELECT BRAND menu is displayed.
5. Use the on-screen keyboard to enter the brand name of your device. Select the brand name from the dropdown menu. Highlight **OK** and press **OK**.

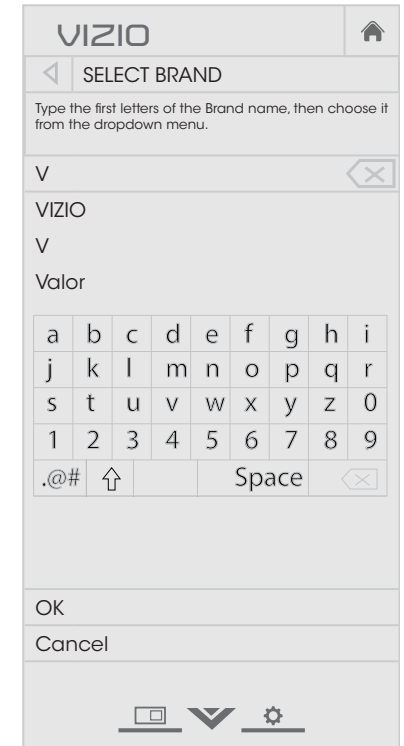

6. Use the **Arrow** buttons on the remote to highlight **Select Model** and press **OK**. The SELECT MODEL menu is displayed.
7. Use the on-screen keyboard to enter the model of your device. Select the model from the dropdown menu. Highlight **OK** and press **OK**.

If you do not know the model of your device, highlight **I Don't Know the Model** and press **OK**.

VIZIO

SELECT MODEL

Type the first letters of the Model name, then choose it from the dropdown menu.

V

VR7M
VBR100
VBR110

a	b	c	d	e	f	g	h	i
j	k	l	m	n	o	p	q	r
s	t	u	v	w	x	y	z	0
1	2	3	4	5	6	7	8	9
.@#	↑				Space			⌫

OK
I Don't Know the Model

8. Use the **Arrow** buttons on the remote to highlight **Confirm Remote Connection** and press **OK**. The CONFIRM REMOTE CONNECTION menu displays.
9. Point the remote at your device and press the Device Power key **INPUT** next to the input key.
 - If the device turned off, highlight **[Device] Turned Off** or **Audio Volume Changed** and press **OK**.
 - If the device did not turn off, highlight **Try the next Code** and repeat step 8.

VIZIO

CONFIRM REMOTE CONNECTION

Point the remote at your device (not your TV), and press the Device Power key **INPUT** next to the input key.

Attempting Remote Code (1 of 1).

Blu-ray Turned Off
Try the Next Code
Manually Enter Code

10. If the device still does not power off or the audio volume did not change, you will need to manually enter a remote control code from your device's manufacturer.
 - a. When you have the remote control code, highlight **Manually Enter Code** and press **OK**.
 - b. Use the number pad on the remote control to enter the code. Highlight **OK** and press **OK**.
 - c. Follow the on-screen instructions to complete the pairing. If you still cannot pair your device, contact your device's manufacturer.

VIZIO

MANUALLY ENTER CODE

Enter the remote control code:

a	b	c	d	e	f	g	h	i
j	k	l	m	n	o	p	q	r
s	t	u	v	w	x	y	z	0
1	2	3	4	5	6	7	8	9
.@#	↑				Space			⌫

OK
Cancel

Unpairing a Device

If you no longer want to control a device with the VIZIO remote, you can unpair it.

To unpair a device:

1. From the DEVICES menu, use the **Arrow** buttons on the remote to highlight the input with the device you want to unpair and press **OK**. The DEVICE STATUS INFORMATION page displays.
2. Use the **Up/Down** buttons to highlight **Unpair** and press **OK**. The device is unpaired.
3. Press the **EXIT** button on the remote control.

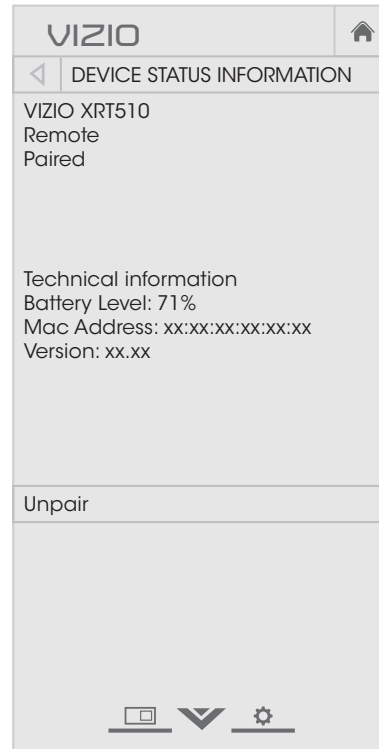

RENAMING DEVICES ON THE INPUT MENU

You can rename the inputs to make them easier to recognize on the Input menu (See *Changing the Input Source* on page 20). For example, if you have a DVD player connected to the Component input, you can rename that input to display “DVD Player.”

To change the name of an input:

1. Press the **MENU** button on the remote. The on-screen menu is displayed.
2. Use the **Arrow** buttons on the remote to highlight **Devices** and press **OK**. The DEVICES menu is displayed.
3. Highlight the input device that you want to rename and press **OK**.
4. Highlight **Name Input** and press **OK**.
5. To use a preset input name:
 - a. Highlight the **Input Port** row and press **OK**.
 - b. Highlight the input name you want to use and press **OK**.
—or—
 To enter a custom name:
 - a. Enter your custom label using the on-screen keyboard.
 - b. Highlight **OK** and press **OK**.
 - c. The Input Name changes to show the custom name that you created.
6. When you have finished naming your input, press the **EXIT** button on the remote.



CHANGING THE TV SETTINGS

Using the System menu, you can:

- View system information
- Set up parental controls
- Change the on-screen menu language
- Set time zone and local settings
- Adjust the CEC settings
- Adjust when the power indicator is illuminated
- Reset the TV settings & set up administrative controls

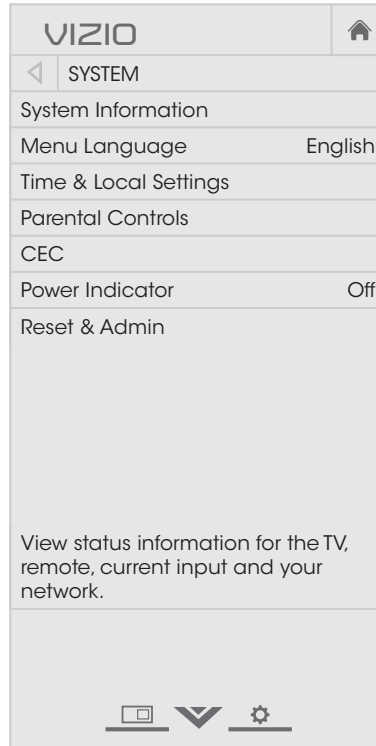

Viewing System Information

To view a summary of the TV settings:

1. Press the **MENU** button on the remote. The on-screen menu is displayed.
2. Use the **Arrow** buttons on the remote to highlight **System** and press **OK**. The SYSTEM menu is displayed.
3. Highlight **System Information** and press **OK**.
4. Use the **Up/Down Arrow** buttons to scroll through the system information.
5. When you are finished reviewing the system information, press the **EXIT** button on the remote.

Using the Parental Controls

The TV's parental controls allow you to prevent the TV from displaying certain channels or programs without a password.

The Parental Controls menu only appears when:

- You are using the tuner to receive your TV signals, such as when you are using an antenna for Over-the-Air signals or when connected to cable TV directly from the wall (no cable box).
- You have a device connected using a composite video cable or a coaxial cable, such as a VCR, satellite or cable box, or DVR.

Accessing the Parental Controls Menu

To access the Parental Controls menu:

1. Press the **MENU** button on the remote. The on-screen menu is displayed.
2. Use the **Arrow** buttons on the remote to highlight **System** and press **OK**. The SYSTEM menu is displayed.
3. Use the **Arrow** buttons on the remote to highlight **Parental Controls** and press **OK**.
4. Enter your parental PIN. If you have not set a PIN, enter the default, **0000**. The PARENTAL CONTROLS menu is displayed.



To set a custom parental PIN, see *Changing the Parental Control PIN* on page 50.

Enabling or Disabling Program Ratings

To manage program content according to its rating, you must enable the Program Rating feature.

To enable or disable the Program Rating feature:

1. From the PARENTAL CONTROLS menu, highlight **Locks** and press **OK**. The LOCKS menu is displayed.
2. Select **On** or **Off** and press **OK**.

Locking and Unlocking Channels

When a channel is locked, it will be inaccessible. Locking a channel is a good way to prevent children from viewing inappropriate material.

To lock or unlock a channel:

1. From the PARENTAL CONTROLS menu, highlight **Channel Locks** and press **OK**. The CHANNEL LOCKS menu is displayed.
2. Highlight the channel you want to lock or unlock and press **OK**.
3. When a channel is **locked**, the **Lock** icon appears **locked**. The channel is not accessible unless the parental PIN is entered.
4. When a channel is **unlocked**, the **Lock** icon appears **unlocked**. The channel is accessible.

Blocking and Unblocking Content by Rating

A channel may sometimes broadcast programs that are meant for children, and at other times broadcast programs that are meant for mature audiences. You may not want to block the channel completely using a channel lock, but you may wish to block certain programs from being viewed.

When this is the case, you can use the TV's Rating Block feature to block content based on its rating.



For a list of content ratings and their definitions, visit www.tvguidelines.org.

To block or unblock content by its rating:

- From the PARENTAL CONTROLS menu, highlight the content type you want to adjust and press **OK**:
 - USA TV** - USA television program broadcasts.
 - USA Movie** - USA movie broadcasts.
 - Canadian English** - Canadian English television program broadcasts.
 - Canadian French** - Canadian French television program broadcasts.
- For each rating type you want to block or unblock, use the **Up/Down** and **Left/Right Arrow** buttons on the remote to highlight the rating type and press **OK**.
- When the rating type is **blocked**, the **Lock** icon appears **locked**. Content with this rating and all higher ratings cannot be viewed.
- When the rating type is **unblocked**, the **Lock** icon appears **unlocked**. Content with this rating and all lower ratings can be viewed.

If you want to block all unrated content, highlight **Block Unrated Shows** and use the **Arrow** buttons on the remote to select **On**.
- When you are finished adjusting the rating level blocks, press the **EXIT** button on the remote.

Changing the Parental Control PIN

If you use the parental controls, you should change the PIN to prevent children from accessing inappropriate material.

To change the parental control PIN:

- From the PARENTAL CONTROLS menu, highlight **Change PIN** and press **OK**. The CHANGE PIN menu is displayed.
- In the **New PIN** field, use the **Number Pad** on the remote to enter your new 4-digit parental control PIN.
- In the **Confirm PIN** field, use the **Number Pad** on the remote to re-enter your new 4-digit parental control PIN.
- Write down your new parental control PIN and save it in a secure location.
- Press the **EXIT** button on the remote.

Resetting the Content Locks

To reset the content locks to the factory-default settings:

- From the PARENTAL CONTROLS menu, highlight **RESET LOCKS** and press **OK**. The TV displays, "Are you sure you want to RESET ALL LOCKS SETTINGS to the factory defaults?"
- Highlight **Yes** and press **OK**.

Changing the On-Screen Menu Language

Your TV can display the on-screen menu in different languages.

To change the on-screen menu language:

1. Press the **MENU** button on the remote. The on-screen menu is displayed.
2. Use the **Arrow** buttons on the remote to highlight **System** and press **OK**. The SYSTEM menu is displayed.
3. Use the **Arrow** buttons on the remote to highlight **Menu Language** and press **OK**. The MENU LANGUAGE menu is displayed.
4. Highlight your preferred language (**English**, **Español**, or **Français**) and press **OK**.
5. Press the **EXIT** button on the remote.

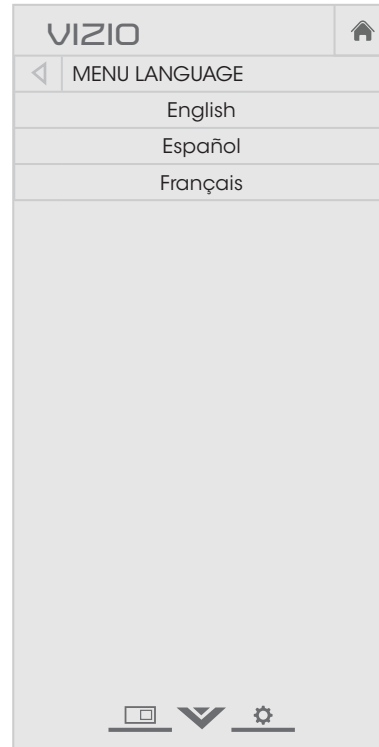

Setting the Time and Local Settings

To ensure the correct time is displayed when you press the **INFO** button, set the TV's time zone:

1. Press the **MENU** button on the remote. The on-screen menu is displayed.
2. Use the **Arrow** buttons on the remote to highlight **System** and press **OK**. The SYSTEM menu is displayed.
3. Use the **Arrow** buttons on the remote to highlight **Time & Local Settings** and press **OK**. The menu headed by the local date and time is displayed.
4. Highlight **Time Zone** and press **OK**. The TIME ZONE menu is displayed.
5. Highlight your time zone and press **OK**.
6. Highlight **Daylight Saving Time** and press **OK**. The DAYLIGHT SAVING TIME menu is displayed. Choose **On** if your locale observes daylight savings time, or **Off** if it does not.
7. If you are in the United States, highlight **Zip Code**. Enter your Zip code using the keypad on the remote, then press **OK**. Zip codes are often used by V.I.A. Plus Apps to give you the most accurate location-based information, such as weather or news.
8. Highlight **Country** and press **OK**. The COUNTRY menu is displayed.
9. Highlight your country and press **OK**.
10. Press the **EXIT** button on the remote.

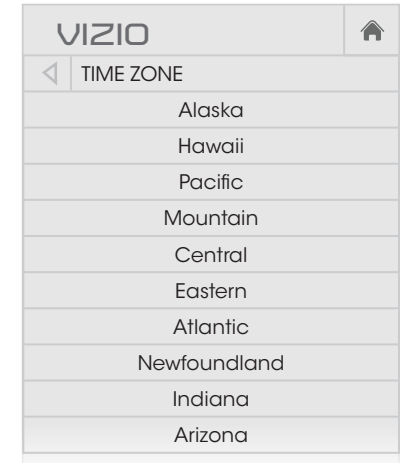

Adjusting the CEC Settings

The CEC function on your TV enables you to control HDMI-connected devices with the included remote without any additional programming.



Not all HDMI devices support CEC. See your device's user manual for details.

To enable, disable, or adjust CEC settings:

1. Press the **MENU** button on the remote. The on-screen menu is displayed.
2. Use the **Arrow** buttons on the remote to highlight **System** and press **OK**. The SYSTEM menu is displayed.
3. Use the **Arrow** buttons on the remote to highlight **CEC** and press **OK**. The CEC menu is displayed.
4. Use the **Arrow** and **OK** buttons to adjust each setting:
 - **CEC** - To use CEC, you must select **On**.
 - **System Audio Control** - When system audio control is on, you can control your device's audio using the TV's remote control.
 - **Device Discovery** - Use this function to determine if your device is connected and supports CEC.
5. Press the **EXIT** button on the remote.

Turning the Power Indicator On or Off

The Power Indicator on the front of your TV normally does not glow when the TV is on. You can change this setting if you prefer the light to be on.

To turn the Power Indicator Light on or off:

1. Press the **MENU** button on the remote. The on-screen menu is displayed.
2. Use the **Arrow** buttons on the remote to highlight **System** and press **OK**. The SYSTEM menu is displayed.
3. Highlight **Power Indicator** and press **OK**.
4. Use the **Up/Down Arrow** buttons to select **On** or **Off**, then press **OK**.

USING THE RESET & ADMIN MENU

You can use the TV's Reset & Admin menu to restore the TV to its factory default settings.

Restoring the TV to Factory Default Settings

All of the on-screen menu settings can be reset to the factory defaults.



If you restore the TV to the factory default settings, all changes you have made to the settings will be lost!

This includes any V.I.A. Plus Apps that you have added and any changes you have made to the settings for those Apps.

To restore the TV to its factory default settings:

1. Press the **MENU** button on the remote. The on-screen menu is displayed.
2. Use the **Arrow** buttons on the remote to highlight **System** and press **OK**. The SYSTEM menu is displayed.
3. Highlight **Reset & Admin** and press **OK**. The RESET & ADMIN menu is displayed.
4. Highlight **Reset TV to Factory Defaults** and press **OK**.
5. If you have changed the default parental control PIN, enter it now.

The TV displays, "Select Reset to restore all TV settings to factory defaults and clear all account information."

6. Highlight **Reset** and press **OK**.
7. Wait for the TV to turn off. The TV will turn back on shortly afterward and the Setup App will begin.

USING THE GUIDED SETUP MENU

Using Guided Setup

The TV's Setup App can be used to easily set up the TV tuner, remote control, and connected devices, or to connect the TV with your network.

To use guided setup:

1. Press the **MENU** button on the remote. The on-screen menu is displayed.
2. Highlight **Guided Setup** and press **OK**.
3. Highlight the guided setup you want to use and press **OK**:
 - **Remote Setup** - Set up the Remote Control.
 - **Tuner Setup** - Set up the TV tuner.
 - **Device Setup** - Set up connected devices.
 - **Network Setup** - Connect the TV to the Internet using your network.
4. Follow the on-screen instructions. When finished, press the **EXIT** button on the remote.

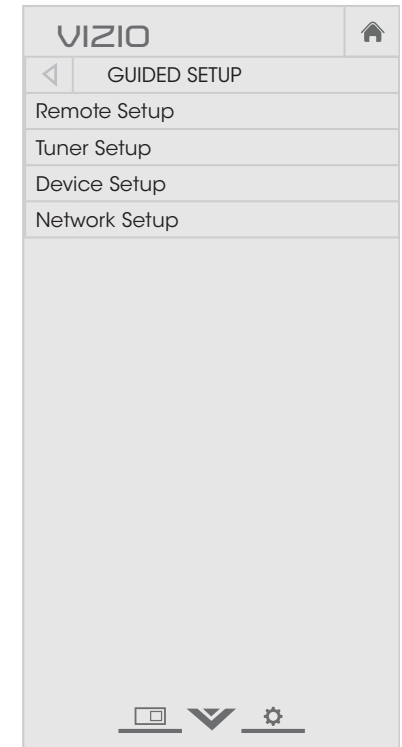

USING THE INFO WINDOW

The Info Window can be displayed by pressing the **INFO** or **GUIDE** button on the remote:

- Press the **INFO** or **GUIDE** button one time to display channel, input, and display information.
- Press the **INFO** or **GUIDE** button two times to display the program title, program rating, audio information, and the start and end times of the program.

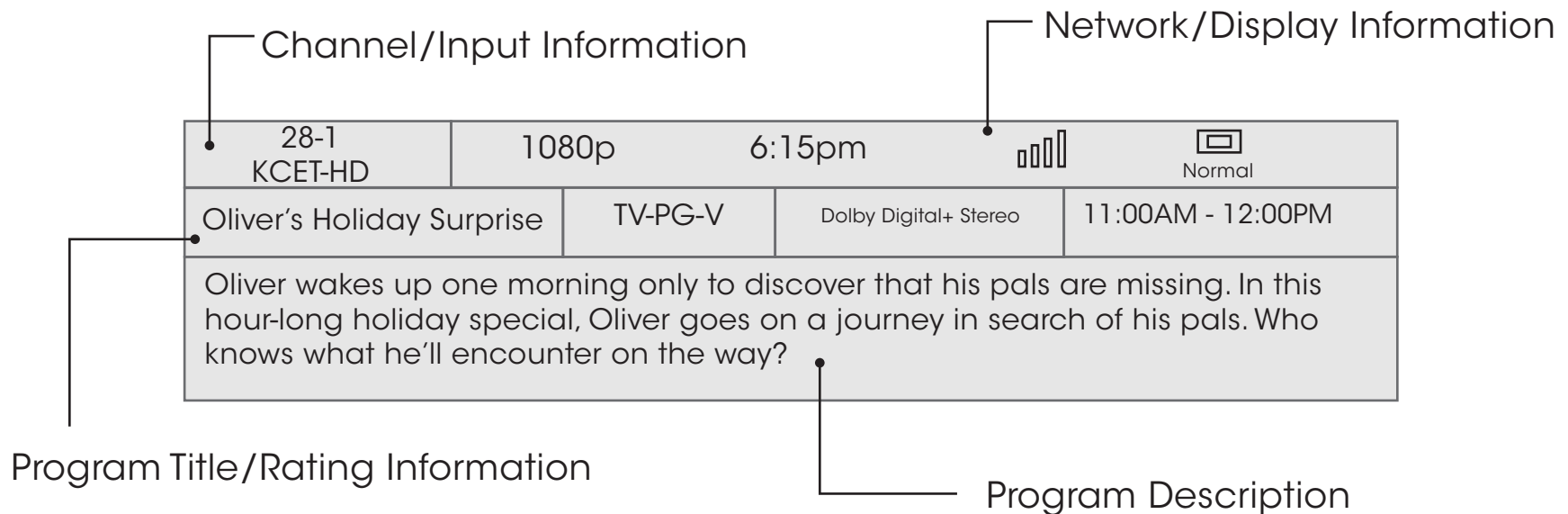

DIGITAL EPISODE GUIDE & INFO WINDOW

USING THE USB MEDIA PLAYER

The USB Media Player allows you to connect a USB thumb drive to your TV and play music, video, or photos.

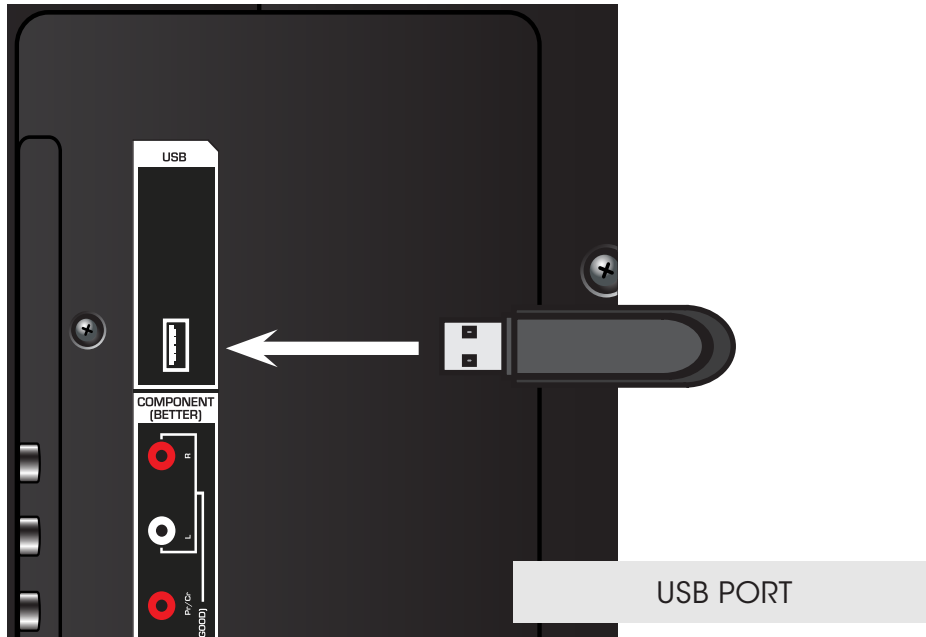

Preparing your USB Drive to Play USB Media

To play USB media, you must first save your photos onto a USB thumb drive:

- The USB thumb drive must be formatted as FAT32.
- Files on the USB thumb drive must end in a supported file extension (.mp3, .jpg, etc.).
- The player is not designed to play media from external hard drives, MP3 players, cameras,

Playing USB Media

To play your USB media:

1. Connect your USB thumb drive to the USB port on the side of the TV.
2. Press the **V Button** on the remote.
3. Use the **Arrow** buttons to highlight the **Multimedia** App in the V.I.A. Plus Dock and press **OK**. (The highlighted App is in the center of the dock.)
4. Use the **Arrow** buttons to highlight the type of media to display (**Music**, **Video**, or **Photo**) and press **OK**.
5. Use the **Arrow** buttons to highlight the file you want to display. Press **OK**. Music or video files play, photos display.



You can display your photos in fullscreen. Select the photo, press **OK**, then highlight **Fullscreen** and press **OK**.

Removing the USB drive from the TV



Do not remove the USB thumb drive while the TV is on. Doing so may damage the drive.

To safely remove your USB drive from the TV:

1. Turn off the TV.
2. Disconnect your USB thumb drive from the USB port on the TV.

Back Button
Highlight this button and press **OK** if you would like to return to the previous screen.

Connected Sources
Displays connected USB devices.

Current Folder

Playback Controls
Use to control audio playback. Highlight Play/Pause, Previous, or Next and press **OK**.

Toggle Music/Photos

Sort by Album/Artist/Track

Toggle between viewing all content and only viewing folders.

Now Playing Information
Displays song title, album title, and artist name.

Progress Bar
Displays the duration of the currently-playing song. The blue bar will lengthen as the song progresses.

Album Art
If included on the USB thumb drive and associated with your music, the album art will display here.

Folder Contents/Playlist
This area displays the contents of the currently selected folder. You can browse among files using the **Arrow** and **OK** buttons on the remote.

Page Information
If your USB thumb drive has more files than can be displayed on a single screen, the page information is displayed here.

#	Track	Album	Artist	Duration
1	Seminal Summer	January Mix Comp	JCheesy	2:42
2	Downspin	January Mix Comp	JCheesy	6:20
3	Fab Apple Dream	January Mix Comp	Oliver	8:46
4	Man of the Year	January Mix Comp	The Dash	4:21
5	Maximal Smooth	January Mix Comp	Rio Steve	7:58

MUSIC PLAYER

Back Button
Highlight this button and press **OK** if you would like to return to the previous screen.

Connected Sources
Displays connected USB devices.

Current Folder

Sort by Date or File

View All or View Folders

Page Information
If your USB thumb drive has more files than can be displayed on a single screen, the page information is displayed here.

Folder Contents/ Playlist
This area displays the contents of the currently selected folder. You can browse among files using the **Arrow** and **OK** buttons on the remote.

VIZIO

Video

USB1: MyFlashDrive

My Videos

MyFlashDrive\Video\root\My Videos

#	File	Date	Duration
1	Family Vacation - California	-	00:23:43
2	26th Birthday Party	-	00:38:18
3	Summer 2012	-	00:41:08
4	Greatest Trip Ever	-	00:05:32

Sort: Date New-Old

View: Folders

Page 1 of 1

Connected Sources
Displays connected USB devices.

Back Button
Highlight this button and press **OK** if you would like to return to the previous screen.

Current Folder
Displays the folder path.

Folder Contents
This area displays the contents of the currently selected folder. You can browse among files using the **Arrow** and **OK** buttons on the remote.

Current Folder
Displays the folder path.

Start Fullscreen Slideshow
Start Slideshow

Sort by Date or File Name
Sort: Name A-Z

View Thumbnails/Folders
View: Thumbnails

Adjust Slideshow Settings
Settings

View Music Files
Browse Music

Photo Information
Displays name, resolution, and file size for currently selected photo.

Page Information
If your USB thumb drive has more files than can be displayed on a single screen, the page information is displayed here.

PHOTO VIEWER

VIZIO Internet Apps Plus® (V.I.A. Plus) delivers popular online content to your TV. V.I.A. features a selection of Apps that allow you to watch movies and TV shows, listen to music, get weather and news information, and more—all on demand.



A high-speed Internet connection is required to receive product updates and to access online content.

See *Using the Network Connection Menu on page 35* if your TV is not yet connected to your home network.

USING THE V.I.A. PLUS APP DOCK

The V.I.A. Plus App Dock is where all of your V.I.A. Apps are accessed.

To launch an App from the Dock:

1. Press the **V Button** on the remote.
2. Highlight a V.I.A. Plus App by scrolling left and right using the **Left/Right Arrow** buttons on the remote. (The highlighted App is in the center of the dock.)
3. Press the **OK** button on the remote to launch the App.



Using the Hot Keys

Use the following colored buttons on the remote to perform common V.I.A. tasks:

- **Yellow** - Not used.
- **Blue** - Change the size of the main display window when an App is open in the sidebar.
- **Red** - Not used.
- **Green** - View settings for an open App.



Hot Keys



Note: App location, appearance, and availability subject to change without notice.

USING THE FULLSCREEN V.I.A. PLUS APPS WINDOW

The fullscreen V.I.A. Plus apps window allows you to add and store apps. The Apps on the first page are displayed in the Dock and Apps on additional pages can be moved to the Dock.

To open the Fullscreen V.I.A. Plus Apps Window:

1. Press the **V Button** on the remote twice.
2. Highlight an App by using the **Arrow** buttons on the remote.

3. Press the **OK** button on the remote to launch the App.
4. To exit from an open App or to close the App Dock, press the **Exit** button on the remote.



Note: App location, appearance, and availability subject to change without notice.

FULLSCREEN V.I.A. PLUS APPS WINDOW OVERVIEW

The Fullscreen V.I.A. Plus Apps window allows you to add, delete and organize your Apps. The My Apps tab displays Apps that are already installed on your TV. The Apps on the first page are displayed in the V.I.A. Plus App Dock.



Apps with a small lock icon in the right-hand corner cannot be deleted.

The following tabs are located at the top of your Fullscreen V.I.A. Plus Apps Window:

- **My Apps:** Displays apps that are installed on your TV.
- **Featured:** Displays apps that are recommended by Yahoo!
- **Latest:** Displays apps that were most recently added to the library of apps.



You can also preview Apps without installing them. Simply highlight the App you wish to preview and press **OK** to open it.

- **All Apps:** Displays every app that is available for download.
- **Categories:** Displays apps sorted into categories: Spotlight, Yahoo!, Weather, News and Finance, Movies and TV, Photos and Video, Sports, Music, Social, Information, Fun and Games, Shopping, and Local TV.
- **App Info (⚙️):** Displays App software information and development settings.

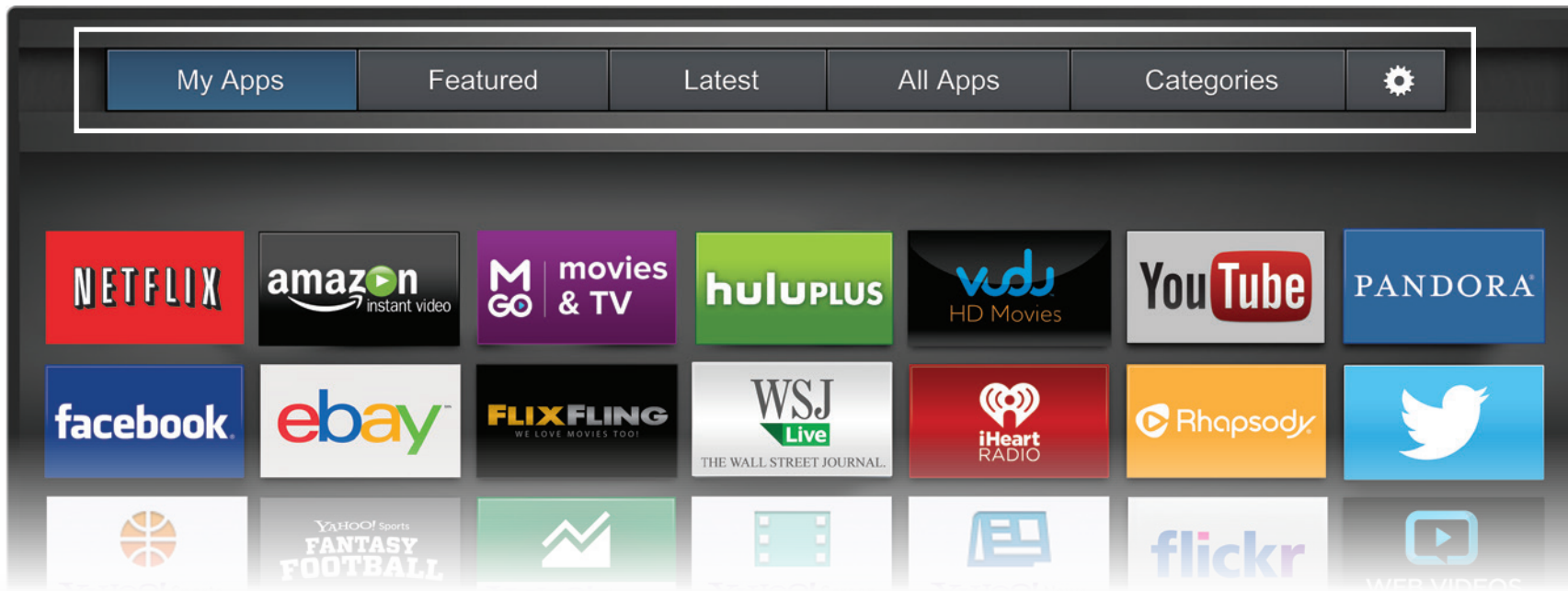

Note: App location, appearance, and availability subject to change without notice.

CUSTOMIZING THE V.I.A. PLUS APPS WINDOW

You can add, delete, and move apps around on your My Apps tab for a custom look and feel.

Adding an App to the My Apps Tab

To add an app to your TV:

1. Use the **Arrow** buttons on the remote to highlight the app you wish to add.
2. Press and hold the **OK** button until [App Name] has been added to your My Apps list appears.

Once the app has been installed, a star appears in the top right-hand corner of the app icon as shown below.



Note: App location, appearance, and availability subject to change without notice.

Deleting an App from the My Apps Tab

To delete an app from your TV:

1. Use the **Arrow** buttons on the remote to highlight the App you wish to delete.
2. Press and hold the **OK** button. The following options appear:

Note: App location, appearance, and availability subject to change without notice.

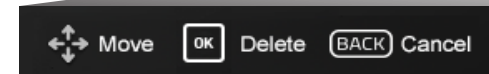
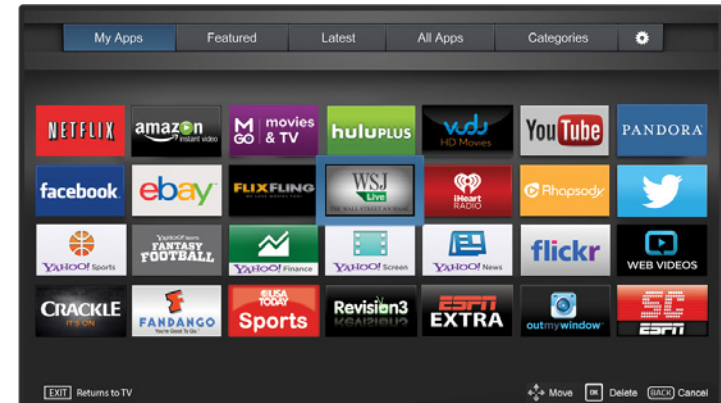

3. Press **OK** to delete the app. The following dialog box appears:

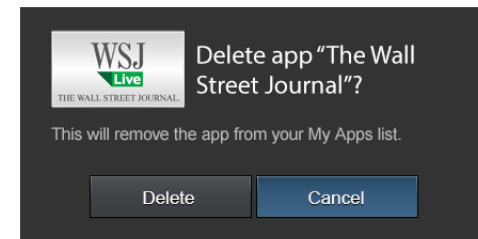

4. Use the **Left/Right** Arrow buttons to select **Delete** and press **OK**. The App is removed from your My Apps tab.

Moving an App in My Apps

You can organize your Apps on your My Apps tab by moving them where you want.

To move the Apps on your My Apps tab:

1. Use the **Arrow** buttons on the remote to highlight the App you wish to move.
2. Press and hold the **OK** button. The following options appear:

App location, appearance, and availability subject to change without notice.

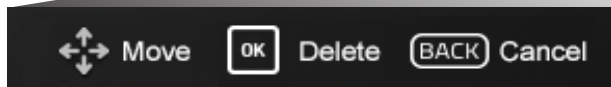
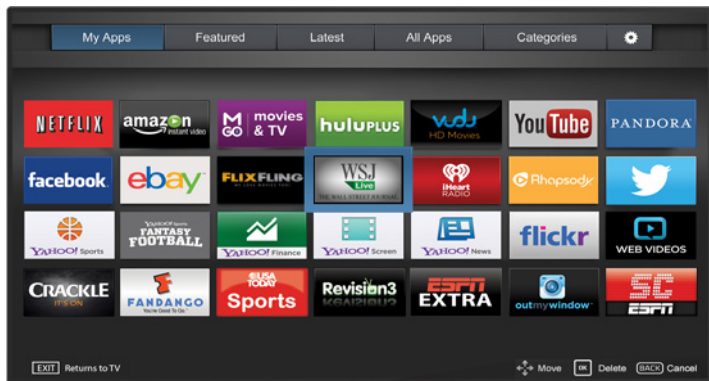

3. Use the **Arrow** buttons to move the App to the desired location and press **OK** to place the app. When you can move the app, it appears as shown below.

App location, appearance, and availability subject to change without notice.

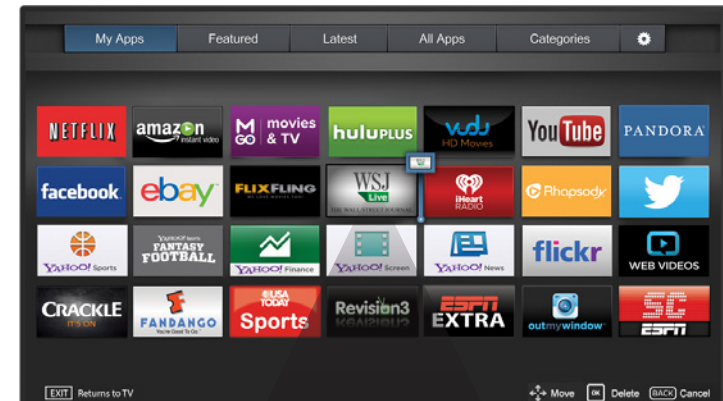

Cursor showing the location that the App will move to.

DO YOU HAVE QUESTIONS?
LET US HELP!

YOUR PRODUCT INCLUDES FREE LIFETIME TECH SUPPORT

The VIZIO support team is highly trained and is based in the United States.

We can help with:

- New Product Setup
- Connecting Your Devices
- Technical Problems
- And More

Phone: (877) 878-4946 (TOLL-FREE)

Email: techsupport@VIZIO.com

Web: www.VIZIO.com/support

Hours of operation:

Monday - Friday: 5 AM TO 8 PM (PST)

Saturday - Sunday: 7 AM TO 4 PM (PST)

We speak English • Se habla Español • Nous parlons Français



The remote is not responding.

- Make sure the batteries are properly inserted matching the - and + symbols.
- Replace the batteries with fresh ones.
- Reset the remote: **Press and hold** the **Fast-Forward** and **Enter** buttons for 10 seconds. Re-pair the remote. See *Pairing a VIZIO Remote Control on page 43*.

The TV displays “No Signal.”

- Press the **INPUT** button on the remote control to select a different input source.
- If you are using cable TV or antenna connected directly to the TV, scan for channels. See *Scanning for Channels on page 37*.

There is no power.

- Ensure the TV is plugged into a working electrical outlet.
- Ensure the power cable is securely attached to the TV.
- Press the **Power/Standby** button on the remote or on the back of the TV to turn the TV on.

The power is on, but there is no image on the screen.

- Ensure all cables are securely attached to the TV.
- Ensure all devices are connected correctly. Devices differ; see your device’s user manual for details.
- Adjust Brightness, Contrast, or Backlight. See *Adjusting the Picture Settings on page 22*.
- Press the **INPUT** button on the remote to select a different input source.

There is no sound.

- Press Volume Up on the remote control.
- Press the **MUTE** button on the remote to ensure mute is off.
- Check the audio settings. See *Adjusting the Audio Settings on page 30*.
- Check the audio connections of external devices (Blu-ray player, game console, cable/satellite box) that are connected to the TV.
- If you are using an antenna, the signal strength of the channel may be low. Ensure your antenna is connected securely to the TV and move the antenna around the room or close to a window for the best signal.

The sound is flat or dialog is not audible.

- Turn off Volume Leveling. See *Adjusting the Audio Settings on page 30*.

The colors on the TV don’t look right.

- Adjust the Color and Tint settings in the Picture menu. See *Adjusting the Picture Settings on page 22*.
- Check all cables to ensure they are securely attached.

The buttons on the remote aren’t working.

- Ensure you are only pressing one button at a time.
- Point the remote directly at the TV when pressing a button.
- Replace the remote batteries with new ones. See *Replacing the Batteries on page 9*.

The image quality is not good.

- For the best image quality, view high-definition programs using digital sources. Connect your devices with HDMI cables.
- If you are using an antenna, the signal strength of the channel may be low. Ensure your antenna is connected securely to the TV and move the antenna around the room or close to a window for the best signal.

The picture is distorted.

- Move the TV away from electrical appliances, cars, and fluorescent lights.
- Ensure all cables are securely attached.

The display image does not cover the entire screen.

- If you are using TV, AV, or Component with 480i input, press the  button on the remote to change the screen mode.

The TV has pixels (dots) that are always dark or always lit.

- Your HDTV is precision-manufactured using an extremely high level of technology. However, sometimes pixels may not display correctly. These types of occurrences are inherent to this type of product and do not constitute a defective product.

I see “noise” or static on the screen.

- When your TV’s digital capabilities exceed a digital broadcast signal, the signal is up-converted (improved) to match your TV’s display capabilities. This up-converting can sometimes cause irregularities in the image.
- If you are using an antenna, the signal strength of the channel may be low. Ensure your antenna is connected securely to the TV and move the antenna around the room or close to a window for the best signal.

When I change input source, the volume changes.

- The TV remembers the volume level on each input source. If the volume level on the new input source is higher or lower than the level on the source you switch from, the difference may be noticeable.
- Use the Volume Up/Down buttons on the remote to adjust the volume.

When I change input source, the display image changes size.

- The TV remembers the viewing mode on each input source. If the viewing mode on the new input source differs from the one on the input source you switch from, the difference may be noticeable.
- See *Changing the Screen Aspect Ratio* on page 20.

M401i-A3

Screen Size: 40"

Viewable Area: 40.00"

Dimensions w/ Stand: 36.28" x 23.23" x 7.87"
w/o Stand: 36.28" x 21.54" x 2.02"

Weight w/ Stand: 27.78 lbs
w/o Stand: 24.47 lbs

TV Type: LED

Refresh Rate: 120 Hz

Maximum Resolution: 1920 x 1080

Pixel Pitch: .461 mm (H) x .461 mm (V)

Dynamic Contrast Ratio 10,000,000:1

Response Time: 6 ms

Brightness: 320 nits

Viewing Angle: 176° (H) / 176° (V)

HDMI Inputs: 3

Component Video Inputs: 1

Composite Inputs: 1 (Shared with Component)

RF Antenna Input: 1

M401i-A3**USB 2.0 Ports:** 1**Ethernet:** 1**Audio Outputs:** RCA Analog Stereo Output,
Optical Digital**OSD Language:** English, Spanish, French**Ambient Light Sensor:** Yes**Remote Control Model:** XRT510**Certifications:** UL/cUL, FCC Class B,
HDMI 1.4, Dolby Digital Plus**Compliance:** Energy Star**Voltage Range:** 115V @ 60 Hz**Power Consumption:** 45W**Standby Power:** <1W**Zero Bright Pixel Guarantee:** Yes

ON PARTS AND LABOR

Covers units purchased as new in United States and Puerto Rico Only. VIZIO provides a warranty to the original purchaser of a new Product against defects in materials and workmanship for a period of one (1) year of non-commercial usage and ninety (90) days of commercial use. If a Product covered by this warranty is determined to be defective within the warranty period, VIZIO will either repair or replace the Product at its sole option and discretion.

To obtain warranty service, contact VIZIO Technical Support via e-mail: TechSupport@VIZIO.com or via phone at 877 MY VIZIO (877.698.4946) from 5:00AM to 9:00PM Monday through Friday and 8:00AM to 4:00PM Saturday and Sunday, Pacific Time, or visit www.VIZIO.com. PRE-AUTHORIZATION MUST BE OBTAINED BEFORE SENDING ANY PRODUCT TO A VIZIO SERVICE CENTER. Proof of purchase in the form of a purchase receipt or copy thereof is required to show that a Product is within the warranty period.

Parts and Labor

There will be no charge for parts or labor during the warranty period. Replacement parts and Products may be new or recertified at VIZIO's option and sole discretion. Replacement parts and Products are warranted for the remaining portion of the original warranty or for ninety (90) days from warranty service or replacement, whichever is greater.

Type of Service

Defective Products must be sent to a VIZIO service center to obtain warranty service. VIZIO is not responsible for transportation costs to the service center, but VIZIO will cover return shipping to the customer. PRE-AUTHORIZATION IS REQUIRED BEFORE SENDING ANY PRODUCT TO A VIZIO SERVICE CENTER FOR WARRANTY SERVICE.

Product returns to VIZIO's service centers must utilize either the original carton box and shipping material or packaging that affords an equal degree of protection. VIZIO Technical Support will provide instructions for packing and shipping the covered Product to the VIZIO service center.

Limitations and Exclusions

VIZIO's one-year limited warranty only covers defects in materials and workmanship. This warranty does not cover, for example: cosmetic damage, normal wear and tear, improper operation, improper voltage supply or power surges, signal issues, damages from shipping, acts of God, any type of customer misuse, modifications or adjustments, as well as installation and set-up issues or any repairs attempted by anyone

other than by a VIZIO authorized service center. Products with unreadable or removed serial numbers, or requiring routine maintenance are not covered. This one year limited warranty does not cover Products sold "AS IS", "FACTORY RECERTIFIED", or by a non-authorized reseller.

THERE ARE NO EXPRESS WARRANTIES OTHER THAN THOSE LISTED OR DESCRIBED ABOVE. ANY IMPLIED WARRANTIES, INCLUDING ANY IMPLIED WARRANTY OF MERCHANTABILITY AND FITNESS FOR A PARTICULAR PURPOSE, SHALL BE LIMITED IN DURATION TO THE PERIOD OF TIME SET FORTH ABOVE. VIZIO'S TOTAL LIABILITY FOR ANY AND ALL LOSSES AND DAMAGES RESULTING FROM ANY CAUSE WHATSOEVER INCLUDING VIZIO'S NEGLIGENCE, ALLEGED DAMAGE, OR DEFECTIVE GOODS, WHETHER SUCH DEFECTS ARE DISCOVERABLE OR LATENT, SHALL IN NO EVENT EXCEED THE PURCHASE PRICE OF THE PRODUCT. VIZIO SHALL NOT BE RESPONSIBLE FOR LOSS OF USE, LOSS OF INFORMATION OR DATA, COMMERCIAL LOSS, LOST REVENUE OR LOST PROFITS, OR OTHER INCIDENTAL OR CONSEQUENTIAL DAMAGES. SOME STATES DO NOT ALLOW LIMITATIONS ON HOW LONG AN IMPLIED WARRANTY LASTS OR THE EXCLUSION OF INCIDENTAL OR CONSEQUENTIAL DAMAGES, SO THE ABOVE LIMITATIONS OR EXCLUSIONS MAY NOT APPLY TO YOU. THIS WARRANTY GIVES YOU SPECIFIC LEGAL RIGHTS, AND YOU MAY ALSO HAVE OTHER RIGHTS, WHICH VARY FROM STATE TO STATE. THIS WARRANTY IS SUBJECT TO CHANGE WITHOUT NOTICE.

CHECK WWW.VIZIO.COM FOR THE MOST CURRENT VERSION.

Personal Data

If your VIZIO product is capable of storing personal data and other information, ALL CONTENTS AND INFORMATION WILL BE DELETED IN THE COURSE OF SOME IN-HOME AND ALL SHIP-IN WARRANTY SERVICE. If this occurs, your product will be restored to you configured as originally purchased. You will be responsible for restoring all applicable data and passwords. Recovery and reinstallation of user data is not covered under this Limited Warranty. In order to protect your personal information, VIZIO recommends that you always clear all personal information from the unit before it is serviced, regardless of the servicer.

Zero Bright Pixel Defect Guarantee

This policy covers "zero bright pixel" defects for the duration of the limited "ONE YEAR WARRANTY" on select new product purchases. To determine if this guarantee applies to your product, refer to the "DETAILS" tab of the model's product information page (www.VIZIO.com) or look for the "zero bright pixel" guarantee on the box.

FCC Class B Radio Interference Statement

NOTE: This equipment has been tested and found to comply with the limits for a Class B digital device, pursuant to Part 15 of the FCC Rules. These limits are designed to provide reasonable protection against harmful interference in a residential installation. This equipment generates, uses and can radiate radio frequency energy, and if not installed and used in accordance with the instructions, may cause harmful interference to radio communications. However, there is no guarantee that interference will not occur in a particular installation. If this equipment does cause harmful interference to radio or television reception, which can be determined by turning the equipment off and on, the user is encouraged to try to correct the interference by one or more of the following measures:

1. Reorient or relocate the receiving antenna.
2. Increase the separation between the equipment and receiver.
3. Connect the equipment into an outlet on a circuit different from that to which the receiver is connected.
4. Consult the dealer or an experienced radio/TV technician for help.

This device complies with Part 15 of the FCC Rules. Operation is subject to the following two conditions: (1) this device may not cause harmful interference, and (2) this device must accept any interference received, including interference that may cause undesired operation.

Notice

1. The changes or modifications not expressly approved by the party responsible for compliance could void the user's authority to operate the equipment.
2. Shielded interface cables and AC power cord, if any, must be used in order to comply with the emission limits.
3. The manufacturer is not responsible for any radio or TV interference caused by unauthorized modification to this equipment. It is the responsibilities of the user to correct such interference.

FCC warning

Changes or modifications not expressly approved by the party responsible for compliance with the FCC Rules could void the user's authority to operate this equipment.

Caution

Always use an AC/DC power adapter that is properly grounded. Use the AC cords listed below for each area.

USA: UL

Canada: CSA

Germany: VDE

UK: BASE/BS

Japan: Electric Appliance Control Act

Open Source Software Notice

Your VIA device may contain GPL executables and LGPL libraries that are subject to the PL2.0/LGPL2.1 License Agreements. VIZIO offers to provide source code to you on CD-ROM for a processing fee covering the cost of performing such distribution, such as the cost of media, shipping and handling upon request made to VIZIO at www.VIZIO.com.

This offer is valid for a period of three (3) years from the date of the distribution of this VIA device by VIZIO.

You can obtain a copy of the GPL, LGPL licenses from:

<http://www.gnu.org/licenses/old-licenses/gpl-2.0.html>

and

<http://www.gnu.org/licenses/oldlicenses/lgpl-2.1.html>

You can also obtain a copy of gSOAP public license from:

<http://www.cs.fsu.edu/~engelen/license.html>

Please visit www.VIZIO.com for attribution of copyrights to any open source software on your VIZIO VIA device.

Permission is hereby granted, free of charge, to any person obtaining a copy of any such software and associated documentation files (the "Open Source Software"), to deal in the Open Source Software without restriction, including without limitation the rights to use, copy, modify, merge, publish, distribute, sublicense, and/or sell copies of the Open Source Software, and to permit persons to whom the Open Source Software is furnished to do so, subject to the following conditions:

THE SOFTWARE IS PROVIDED "AS IS", WITHOUT WARRANTY OF ANY KIND, EXPRESS OR IMPLIED, INCLUDING BUT NOT LIMITED TO THE WARRANTIES OF MERCHANTABILITY, FITNESS FOR A PARTICULAR PURPOSE AND NONINFRINGEMENT. IN NO EVENT SHALL THE AUTHORS OR COPYRIGHT HOLDERS BE LIABLE FOR ANY CLAIM, DAMAGES OR OTHER LIABILITY, WHETHER IN AN ACTION OF CONTRACT, TORT OR OTHERWISE, ARISING FROM, OUT OF OR IN CONNECTION WITH THE SOFTWARE OR THE USE OR OTHER DEALINGS IN THE SOFTWARE.

VIZIO Internet Applications Disclaimer

VIZIO Internet Applications (“VIA”) affords the opportunity to access third party Internet product offerings or services (“VIA Services”) on certain VIZIO TVs. The VIA Services accessible herein are provided as per our agreement with these third parties. These agreements are subject to change, interruption, suspension (including termination) at any time and for various reasons. VIZIO makes no warranties or representations that any particular VIA Service will be accessible, available, function in any particular manner or function at all.

To use these VIA Services, you must obtain access to the Internet, either directly or through devices that access the Internet and pay any service fees associated with such access. In addition, you must provide all equipment necessary to make such connection to the Internet including a modem or other Internet access device.

VIZIO or said third parties providing VIA Services reserve the right to delete data from their servers, or prevent access to their servers or to change data categories, product offerings or service levels for any reason that VIZIO or said third parties deem sufficient in their sole discretion at any time, without notice. Some or all of the data or functionality of VIA Services may require additional payment by you. However, in no event will you be charged for any VIA Services unless those charges are made available to you in advance. VIZIO makes no warranties or representations of any kind as to the accuracy, currency, or completeness of any information contained on the data servers of such third party providers of any VIA Services. Furthermore, we do not review, control, or endorse the content, products or services of VIA Services or their data servers.

Your rights to use the widget links to access VIA Services is governed by the VIZIO Internet Applications Software License Agreement (“VIA Software License Agreement”), the terms of which are available in your Product Guide, all of which are incorporated herein by this reference. In the event of a conflict between this VIZIO Internet Applications Disclaimer and the VIA Software License Agreement, the VIA Software License Agreement shall control.

VIZIO INTERNET APPLICATIONS SOFTWARE LICENSE AGREEMENT

THE FOLLOWING AGREEMENT EXPLAINS HOW YOU MAY USE THE VIZIO INTERNET APPLICATIONS (“VIA”) TO ACCESS THIRD PARTY INTERNET PRODUCT OFFERINGS AND SERVICES (“VIA SERVICES”) AND THE VIZIO SOFTWARE INSTALLED ON YOUR VIZIO HD TV. BY USING THE VIZIO INTERNET APPLICATIONS, YOU CONSENT AND AGREE TO BE BOUND BY ALL OF THE TERMS AND CONDITIONS BELOW AND YOU MAY, SUBJECT TO THOSE TERMS AND CONDITIONS, USE THE VIZIO SOFTWARE AND ACCESS THE VIA SERVICES.

VIZIO SOFTWARE LICENSE AGREEMENT

The following terms and conditions govern the use of any software on your VIZIO HD TV:

1. General. The software, documentation and any fonts accompanying this License Agreement whether on disk, in read only memory, on any other media or in any other form (collectively the “VIZIO Software”) are licensed, not sold, to you by VIZIO, Inc. (“VIZIO”) for use only under the terms of this License Agreement, and VIZIO reserves all rights not expressly granted to you. The rights granted herein are limited to VIZIO’s and its third party licensors’ intellectual property rights in the VIZIO Software and do not include any other patents or intellectual property rights. You own the media on which the VIZIO Software is recorded or resides but VIZIO and/or its licensor(s) retain ownership of the VIZIO Software itself. The terms of this License Agreement will govern any software upgrades provided or made available by or through VIZIO that replace and/or supplement the original VIZIO Software, unless such upgrade is accompanied by a separate license in which case the terms of that license will govern.

2. Permitted Uses and Restrictions. This License Agreement allows you to use the VIZIO Software and, through functions solely found within the VIZIO HD TV, this Agreement also allows you to install upgrades thereto. The VIZIO Software may be used to access VIA Services and view materials so long as such use is limited to materials in which you are authorized or legally permitted to view. You may not make the VIZIO Software or VIA Services available over a network or where it could be used by multiple televisions at the same time. Except as and only to the extent expressly permitted in this License Agreement or by applicable law, you may not copy, decompile, reverse engineer, disassemble, modify, or create derivative works of the VIZIO Software or any part thereof. **THE VIZIO SOFTWARE AND VIA SERVICES ARE NOT INTENDED FOR USE IN ANY EQUIPMENT OR ENVIRONMENT IN WHICH THE FAILURE OF THE VIZIO SOFTWARE OR VIA SERVICES COULD LEAD TO DEATH, PERSONAL INJURY, OR SEVERE PHYSICAL OR ENVIRONMENTAL DAMAGE.**

3. Transfer. You may not rent, lease, lend, redistribute or sublicense the VIZIO Software or access to the VIA Services. You may, however, make a one-time permanent transfer of all of your license rights to the VIZIO Software to another party, provided that: (a) the transfer must include the VIZIO HD TV, including all its component parts, original media, printed materials and this License Agreement; (b) you do not retain any copies of the VIZIO Software, full or partial, including copies stored on a computer or other storage device; and (c) the party receiving the VIZIO HD TV and VIZIO Software reads and agrees to accept the terms and conditions of this License Agreement.

4. Consent to Use of Collected Data. You agree that VIZIO and its third party providers of VIA Services may collect and use technical, non-technical and

related information, including but not limited to information about your use of the VIZIO Software, the VIA Services, content viewed and attached peripherals, products or services purchased, that is gathered periodically to facilitate the provision of software updates, product support and other services to you, including additional or different VIA Services related to the VIZIO Software and to verify compliance with the terms of this License Agreement. VIZIO and its third party providers of VIA Services and/or other providers may use this information, as long as it is in a form that does not personally identify you, to improve our products or to provide services or technologies to you.

5. VIA Services and other Services. The VIZIO software affords the opportunity to access third party Internet product offerings or services ("VIA Services"). The VIA Services accessible herein are provided as per our agreement with certain third parties. These agreements are subject to change, interruption, suspension, removal (including termination) at any time and for various reasons. Moreover, VIZIO or its third party providers of VIA Services reserve the right to delete data from their servers, or prevent access to their servers or to change data categories, product offerings or service levels for any reason that VIZIO or said third parties deem sufficient in their sole discretion at any time, without notice. VIZIO may also impose additional or different limits on the use of or access to certain VIA Services, in any case and without notice or liability. VIZIO makes no warranties or representations that any particular VIA Service will be accessible, available, function in any particular manner or function at all.

Use of the VIA Services may require you to accept additional terms of service or end user license agreements which will be presented to you before you can use such Services. Some or all of the data, functionality of VIA Services may require additional payment by you. However, in no event will you be charged for any VIA Services unless those charges are made available to you in advance.

6. Disclaimer as to Content on VIA Services. Certain VIA Services may include materials from third parties or links to certain third party data servers. You acknowledge and agree that VIZIO is not responsible for examining or evaluating the content or accuracy of any VIA Services, their data servers or related third-party materials. VIZIO does not warrant or endorse and does not assume and will not have any liability or responsibility for any third-party materials or websites, or for any other materials, products, or services of third parties. Links to VIA Services and any associated links to other data servers are provided solely as a convenience to you. To the extent provided, content types or descriptions of VIA Services provided for convenience, and you acknowledge and agree that VIZIO does not guarantee their accuracy. You understand that by using any of the VIA Services, you may encounter content that may be deemed offensive,

indecent, or objectionable, which content may or may not be identified as having explicit language. Nevertheless, you agree to use the VIA Services at your sole risk and that VIZIO shall have no liability to you for content that may be found to be offensive, indecent, or objectionable.

You agree that you will not use any third-party materials in a manner that would infringe or violate the rights of any other party, and that VIZIO is not in any way responsible for any such use by you.

7. Internet Access Required. To use these VIA Services, you must obtain access to the Internet, either directly or through devices that access the Internet and pay any service fees associated with such access. In addition, you must provide all equipment necessary to make such connection to the Internet including a modem or other Internet access device.

8. Upgrades, Support. VIZIO or its third party providers may elect, but shall be under no obligation, to provide you with customer support and/or software upgrades, enhancements, or modifications to the VIZIO Software or VIA Services (collectively, "Support"), in its sole discretion, and may terminate such Support at any time without notice to you. VIZIO and its third party providers reserve the right to charge you for any Support it provides but will make a schedule of those charges available to you prior to your incurring any costs.

9. Termination. This License is effective until terminated. Your rights under this License will terminate automatically without notice from VIZIO if you fail to comply with any term(s) of this License Agreement. Upon the termination of this License Agreement, you shall cease all use of the VIZIO Software and VIA Services.

10. Limited Warranty on VIZIO Media. VIZIO warrants the media on which the VIZIO Software is recorded and delivered by VIZIO to be free from defects in materials and workmanship under normal use for a period of ninety (90) days from the date of original retail purchase. Your exclusive remedy under this Section shall be, at VIZIO's option, a refund of the purchase price of the product containing the VIZIO Software or replacement of the VIZIO Software which is returned to VIZIO or a VIZIO authorized representative with a copy of the receipt. THIS LIMITED WARRANTY AND ANY IMPLIED WARRANTIES ON THE MEDIA INCLUDING, BUT NOT LIMITED TO, THE IMPLIED WARRANTIES OF MERCHANTABILITY, OF SATISFACTORY QUALITY, AND OF FITNESS FOR A PARTICULAR PURPOSE, ARE LIMITED IN DURATION TO NINETY (90) DAYS FROM THE DATE OF ORIGINAL RETAIL PURCHASE. SOME JURISDICTIONS DO NOT ALLOW LIMITATIONS ON HOW LONG AN IMPLIED WARRANTY LASTS, SO THE ABOVE LIMITATION MAY NOT APPLY TO YOU. THE LIMITED WARRANTY SET FORTH HEREIN IS THE ONLY WARRANTY MADE TO YOU AND IS PROVIDED IN LIEU OF ANY OTHER WARRANTIES (IF ANY) CREATED BY ANY DOCUMENTATION OR PACKAGING. THIS LIMITED WARRANTY GIVES YOU SPECIFIC LEGAL RIGHTS,

AND YOU MAY ALSO HAVE OTHER RIGHTS WHICH VARY BY JURISDICTION.

11. Disclaimer of Warranties. YOU EXPRESSLY ACKNOWLEDGE AND AGREE THAT USE OF THE VIZIO SOFTWARE AND VIA SERVICES (AS DEFINED ABOVE) IS AT YOUR SOLE RISK AND THAT THE ENTIRE RISK AS TO SATISFACTORY QUALITY, PERFORMANCE, ACCURACY AND EFFORT IS WITH YOU. EXCEPT FOR THE LIMITED WARRANTY ON MEDIA SET FORTH ABOVE AND TO THE MAXIMUM EXTENT PERMITTED BY APPLICABLE LAW, THE VIZIO SOFTWARE AND VIA SERVICES ARE PROVIDED "AS IS", WITH ALL FAULTS AND WITHOUT WARRANTY OF ANY KIND, AND VIZIO AND VIZIO'S THIRD PARTY PROVIDERS OF VIA SERVICES AND THIRD PARTY LICENSORS (COLLECTIVELY REFERRED TO AS "VIZIO" FOR THE PURPOSES OF SECTIONS 10 AND 11) HEREBY DISCLAIM ALL WARRANTIES AND CONDITIONS WITH RESPECT TO THE VIZIO SOFTWARE AND SERVICES, EITHER EXPRESS, IMPLIED OR STATUTORY, INCLUDING, BUT NOT LIMITED TO, THE IMPLIED WARRANTIES AND/OR CONDITIONS OF MERCHANTABILITY, OF SATISFACTORY QUALITY, OF FITNESS FOR A PARTICULAR PURPOSE, OF ACCURACY, OF QUIET ENJOYMENT, AND NON-INFRINGEMENT OF THIRD PARTY RIGHTS. VIZIO DOES NOT WARRANT AGAINST INTERFERENCE WITH YOUR ENJOYMENT OF THE VIZIO SOFTWARE OR VIA SERVICES, THAT THE FUNCTIONS CONTAINED IN THE VIZIO SOFTWARE OR VIA SERVICES WILL MEET YOUR REQUIREMENTS, THAT THE OPERATION OF THE VIZIO SOFTWARE OR VIA SERVICES WILL BE UNINTERRUPTED OR ERROR-FREE, OR THAT DEFECTS IN THE VIZIO SOFTWARE OR VIA SERVICES WILL BE CORRECTED. NO ORAL OR WRITTEN INFORMATION OR ADVICE GIVEN BY VIZIO OR A VIZIO AUTHORIZED REPRESENTATIVE SHALL CREATE A WARRANTY. SHOULD THE VIA SOFTWARE OR VIA SERVICES PROVE DEFECTIVE, YOU ASSUME THE ENTIRE COST OF ALL NECESSARY SERVICING, REPAIR OR CORRECTION. SOME JURISDICTIONS DO NOT ALLOW THE EXCLUSION OF IMPLIED WARRANTIES OR LIMITATIONS ON APPLICABLE STATUTORY RIGHTS OF A CONSUMER, SO THE ABOVE EXCLUSION AND LIMITATIONS MAY NOT APPLY TO YOU.

12. Limitation of Liability. TO THE EXTENT NOT PROHIBITED BY LAW, IN NO EVENT SHALL VIZIO BE LIABLE FOR PERSONAL INJURY, OR ANY INCIDENTAL, SPECIAL, INDIRECT OR CONSEQUENTIAL DAMAGES WHATSOEVER, INCLUDING, WITHOUT LIMITATION, DAMAGES FOR LOSS OF PROFITS, LOSS OF DATA, BUSINESS INTERRUPTION OR ANY OTHER COMMERCIAL DAMAGES OR LOSSES, ARISING OUT OF OR RELATED TO YOUR USE OR INABILITY TO USE THE VIZIO SOFTWARE OR VIA SERVICES, HOWEVER CAUSED, REGARDLESS OF THE THEORY OF LIABILITY (CONTRACT, TORT OR OTHERWISE) AND EVEN IF VIZIO HAS BEEN ADVISED OF THE POSSIBILITY OF SUCH DAMAGES. SOME JURISDICTIONS DO NOT ALLOW THE LIMITATION OF LIABILITY FOR PERSONAL INJURY, OR OF INCIDENTAL OR CONSEQUENTIAL DAMAGES, SO THIS LIMITATION MAY NOT APPLY TO YOU. In no event shall VIZIO's total liability to you for all damages (other than as may be required by applicable law in cases involving personal injury) exceed the amount of twenty five dollars (\$25.00). The foregoing limitations will apply even if the above stated remedy fails of its essential purpose.

13. Export Control. You may not use or otherwise export or re-export the VIZIO Software except as authorized by United States law and the laws of the jurisdiction in which the VIZIO Software was obtained. In particular, but without limitation, the VIZIO Software may not be exported or re-exported (a) into any U.S. embargoed countries or (b) to anyone on the U.S. Treasury Department's list of Specially Designated Nationals or the U.S. Department of Commerce Denied Person's List or Entity List. By using the VIZIO Software, you represent and warrant that you are not located in any such country or on any such list. You also agree that you will not use these products for any purposes prohibited by United States law, including, without limitation, the development, design, manufacture or production of missiles, or nuclear, chemical or biological weapons.

14. Controlling Law and Severability. This License Agreement will be governed by and construed in accordance with the laws of the State of California, as applied to agreements entered into and to be performed entirely within California between California residents. This License Agreement shall not be governed by the United Nations Convention on Contracts for the International Sale of Goods, the application of which is expressly excluded. If for any reason a court of competent jurisdiction finds any provision, or portion thereof, to be unenforceable, the remainder of this License Agreement shall continue in full force and effect.

15. Complete Agreement; Governing Language. This License Agreement constitutes the entire agreement between the parties with respect to the use of the VIZIO Software licensed hereunder and supersedes all prior or contemporaneous understandings regarding such subject matter, with the exception of any additional terms and conditions you are required to accept if you choose to access VIA Services which will govern your use of such VIA Services. No amendment to or modification of this License Agreement will be binding unless in writing and signed by VIZIO. Any translation of this License Agreement is done for local requirements and in the event of a dispute between the English and any non-English versions, the English version of this License Agreement shall govern.

Other

Image(s) used under license from Shutterstock.com

