



Dear VIZIO Customer,

Congratulations on your new VIZIO VA26L High Definition LCD Television purchase. To get the maximum benefit from your HDTV, read these instructions before making any adjustments, and retain them for future reference. We hope you will experience many years of enjoyment from your new HDTV.

For assistance, call **(877) 698-4946** or e-mail us at techsupport@VIZIO.com.

To purchase or inquire about accessories and installation services for your HDTV, visit our website at www.VIZIO.com or call toll free at **888-VIZIOCE (888-849-4623)**.

We recommend you register your HDTV either by visiting our website (www.VIZIO.com) or by completing and mailing in your registration card. For peace of mind and to protect your investment beyond the standard warranty, VIZIO offers on-site extended warranty service plans. These plans give additional coverage during the standard warranty period. Visit our website or call us to purchase a plan.

Write down the serial number located on the back of your HDTV.

Purchase Date _____

*VIZIO is a registered trademark of VIZIO, Inc. dba V, Inc.
HDMI logo and "High Definition Multimedia Interface" are registered trademarks of HDMI Licensing LLC.
Manufactured under license from Dolby Laboratories.
Dolby and the double-D symbol are trademarks of Dolby Laboratories.*



THE TRADEMARKS SHOWN HEREIN ARE THE PROPERTY OF THEIR RESPECTIVE OWNERS; IMAGES USED ARE FOR ILLUSTRATION PURPOSES ONLY. BRAVO, VIZIO AND THE V LOGO AND WHERE VISION MEETS VALUE AND OTHER VIZIO TRADEMARKS ARE THE INTELLECTUAL PROPERTY OF VIZIO INC. PRODUCT SPECIFICATIONS ARE SUBJECT TO CHANGE WITHOUT NOTICE OR OBLIGATION. © 2008 VIZIO INC. ALL RIGHTS RESERVED.



Important Safety Instructions

Your HDTV is designed and manufactured to operate within defined design limits, and misuse may result in electric shock or fire. To prevent your HDTV from being damaged, the following rules should be observed for the installation, use, and maintenance of your HDTV. Read the following safety instructions before operating your HDTV. Keep these instructions in a safe place for future reference.

- To reduce the risk of electric shock or component damage, switch off the power before connecting other components to your HDTV.
- Unplug the power cord before cleaning your HDTV. A damp cloth is sufficient for cleaning your HDTV. Do not use a liquid or a spray cleaner for cleaning your HDTV. Do not use abrasive cleaners.
- Always use the accessories recommended by the manufacturer to insure compatibility.
- When moving your HDTV from an area of low temperature to an area of high temperature, condensation may form in the housing. Wait before turning on your HDTV to avoid causing fire, electric shock, or component damage.
- Use only with the cart, stand, tripod, bracket, or table specified by manufacturer or sold with your HDTV. When a cart is used, use caution when moving the cart/HDTV combination to avoid injury from tip-over. Do not place your HDTV on an unstable cart, stand, or table. If your HDTV falls, it can injure a person and cause serious damage to your HDTV. Use only a cart or stand recommended by the manufacturer or sold with your HDTV.
- A distance of at least 3 feet should be maintained between your HDTV and any heat source, such as a radiator, heater, oven, amplifier etc. Do not install your HDTV close to smoke. Operating your HDTV close to smoke or moisture may cause fire or electric shock.
- Slots and openings in the back and bottom of the cabinet are provided for ventilation. To ensure reliable operation of your HDTV and to protect it from overheating, be sure these openings are not blocked or covered. Do not place your HDTV in a bookcase or cabinet unless proper ventilation is provided.
- Never push any object into the slots and openings on your HDTV cabinet. Do not place any objects on the top of your HDTV. Doing so could short circuit parts causing a fire or electric shock. Never spill liquids on your HDTV.
- Your HDTV should be operated only from the type of power source indicated on the label. If you are not sure of the type of power supplied to your home, consult your dealer or local power company.
- Do not apply pressure or throw objects at your HDTV. This may compromise the integrity of the display. The manufacturer's warranty does not cover user abuse or improper installations.
- The power cord must be replaced when using different voltage than the voltage specified. For more information, contact your dealer.
- Your HDTV is equipped with a **three-pronged grounded plug (a plug with a third grounding pin)**. This plug will fit only into a grounded power outlet. This is a safety feature. If your outlet does not accommodate the three-pronged, have an electrician install the correct outlet, or use an adapter to ground your HDTV safely.

Do not defeat the safety purpose of the grounded plug.

- When connected to a power outlet, power is always flowing into your HDTV. To totally disconnect power, unplug the power cord.



- The lightning flash with arrowhead symbol within an equilateral triangle is intended to alert the user to the presence of un-isolated, dangerous voltage within the inside of your HDTV that may be of sufficient magnitude to constitute a risk of electric shock to persons.
- The exclamation point within an equilateral triangle is intended to alert the user to the presence of important operating and servicing instructions in the

literature accompanying your HDTV.

- Do not overload power strips and extension cords. Overloading can result in fire or electric shock.
- The wall socket should be installed near your HDTV and easily accessible.
- Only power of the marked voltage can be used for your HDTV. Any other voltage than the specified voltage may cause fire or electric shock
- Do not touch the power cord during lightning. To avoid electric shock, avoid handling the power cord during electrical storms.
- Unplug your HDTV during a lightning storm or when it will not be used for long period of time. This will protect your HDTV from damage due to power surges.
- Do not attempt to repair or service your HDTV yourself. Opening or removing the back cover may expose you to high voltages, electric shock, and other hazards. If repair is required, contact your dealer and refer all servicing to qualified service personnel.
- Keep your HDTV away from moisture. Do not expose your HDTV to rain or moisture. If water penetrates into your HDTV, unplug the power cord and contact your dealer. Continuous use in this case may result in fire or electric shock.
- Do not use your HDTV if any abnormality occurs. If any smoke or odor becomes apparent, unplug the power cord and contact your dealer immediately. Do not try to repair your HDTV yourself.
- Avoid using dropped or damaged appliances. If your HDTV is dropped and the housing is damaged, the internal components may function abnormally. Unplug the power cord immediately and contact your dealer for repair. Continued use of your HDTV may cause fire or electric shock.
- Do not install your HDTV in an area with heavy dust or high humidity. Operating your HDTV in environments with heavy dust or high humidity may cause fire or electric shock.



- Follow instructions for moving your HDTV. Ensure that the power cord and any other cables are unplugged before moving your HDTV.
- When unplugging your HDTV, hold the power plug, not the cord. Pulling on the power cord may damage the wires inside the cord and cause fire or electric shock. When your HDTV will not be used for an extended period of time, unplug the power cord.
- To reduce risk of electric shock, do not touch the connector with wet hands.
- Insert batteries in accordance with instructions. Incorrect polarities may cause the batteries to leak which can damage the remote control or injure the operator.
- If any of the following occurs, contact the dealer:
 - The power cord fails or frays.
 - Liquid sprays or any object drops into your HDTV.
 - Your HDTV is exposed to rain or other moisture.
 - Your HDTV is dropped or damaged in any way.
 - The performance of your HDTV changes substantially.



Television Antenna Connection Protection

External Television Antenna Grounding

If an outside antenna/satellite dish or cable system is connected to your HDTV, make sure that the antenna or cable system is electrically grounded to provide some protection against voltage surges and static charges.

Article 810 of the National Electrical Code, ANSI/NFPA 70, provides information with regard to proper grounding of the mast and supporting structure, grounding of the lead-in wire to an antenna discharge unit, size of the grounding conductors, location of antenna discharge unit, connection to grounding electrodes, and requirements of the grounding electrode.

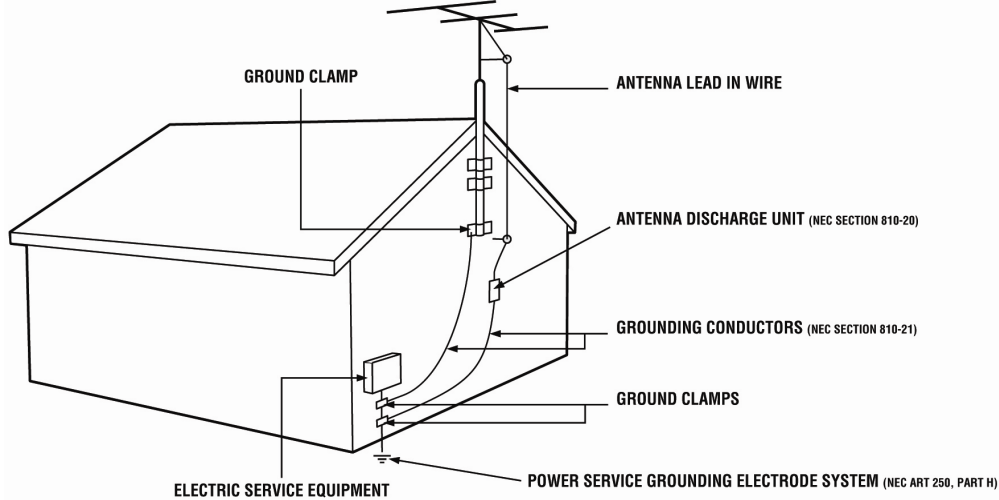

Lightning Protection

For added protection of your HDTV during a lightning storm or when it is left unattended or unused for long periods of time, unplug your HDTV from the wall outlet and disconnect the antenna or cable system.

Power Lines

Do not locate the antenna near overhead light or power circuits, or where it could fall into such power lines or circuits.

Remember, the screen of the coaxial cable is intended to be connected to earth in the building installation.

FCC Bulletin for New TV Owners

After February 17, 2009, a television receiver with only an analog broadcast tuner will require a converter box to receive full power over-the-air broadcasts with an antenna because of the Nation's transition to digital broadcasting. Analog-only TVs should continue to work as before to receive low power, Class A or translator television stations and with cable and satellite TV services, gaming consoles, VCRs, DVD players, and similar products.

Information about the DTV transition is available from <http://www.DTV.gov> or this manufacturer at **877 MY VIZIO (877-698-4946)**, and from <http://www.dtv2009.gov> or **1-888-DTV-2009** for information about subsidized coupons for digital-to-analog converter boxes.

Your HDTV comes with a built-in tuner capable of processing digital broadcasts, making it easier for you to receive this type of signal without the need of an extra converter box.



Table of Contents

FCC Bulletin for New TV Owners.....	5
Opening the Package	8
Package Contents.....	8
Understanding Basic Controls and Connections	9
Front Bezel.....	9
Right Side Panel Controls.....	9
Left Side Panel Controls.....	10
Rear Panel Connections.....	11
VIZIO Remote Control.....	12
Setting Up Your HDTV.....	14
Choosing a video connection.....	14
Connecting Your Cable or Satellite Box.....	15
Using HDMI (Best).....	15
HDMI Connections for Cable or Satellite Boxes with DVI.....	16
Using Component Video (Better).....	17
Using S-Video (Better).....	17
Using Composite Video (Good).....	18
Using Coaxial (Antenna) (Good).....	18
Connecting Coaxial (RF).....	19
Using Your Antenna or Digital Cable for Standard TV or DTV.....	19
Using the Antenna or Cable through Your VCR.....	19
Connecting Your DVD Player.....	20
Using HDMI (Best).....	20
HDMI Connections for DVD Players with DVI.....	21
Using Component Video (Better).....	21
Using S-Video (Better).....	22
Using Composite (AV) Video (Good).....	22
Connecting Your VCR or Video Camera.....	23
Connecting a Computer.....	23
Wall Mounting your HDTV.....	24
Inserting the remote control batteries.....	25
Using your HDTV the first time.....	25
Selecting Inputs.....	28
Fine-tuning the picture.....	29
Using the Program Guide.....	30
Displaying the Information Banner.....	30
Using the On-Screen Display (OSD).....	31
Using a Cable or Satellite Remote Control.....	31
Advanced Settings.....	32
Adjusting the Picture Settings.....	32
Picture Mode.....	32
Backlight.....	33
Brightness.....	33
Contrast.....	34
Color.....	34
Tint.....	35
Sharpness.....	35
Advanced Video.....	37
Adjusting the Audio Settings.....	39
Volume.....	39
Bass.....	39
Treble.....	40
Balance.....	40
Surround.....	41
Speakers.....	41
Lip Sync.....	42
AVL.....	42
Adjusting the TV settings.....	43
Tuner Mode.....	43
Auto Search.....	43



Skip Channel.....	44
MTS	45
Time Zone.....	45
Daylight Saving	46
Adjusting the Setup settings.....	47
Language	47
Source.....	47
Sleep Timer.....	48
Wide.....	48
CC (Closed Caption).....	49
Digital CC Style.....	49
H/V Position	50
Reset All Setting.....	51
Adjusting the Parental Control settings.....	52
Channel Block	52
TV Rating	53
Movie Rating	54
Check for New DTV Rating	55
Blocked Unrated TV	55
Access Code Edit.....	56
Understanding Viewing Modes.....	57
Normal Mode.....	57
Wide Mode.....	57
Panoramic Mode.....	57
Maintaining and Troubleshooting.....	58
Maintenance.....	58
Important.....	58
Cleaning the Housing and Remote Control.....	58
Cleaning the Screen.....	58
Troubleshooting	59
Telephone & Technical Support.....	60
Regulations and Specifications.....	61
Compliance	61
FCC Class B Radio Interference Statement.....	61
Specifications	62
Preset Computer Resolutions	63
VIZIO LIMITED PRODUCT WARRANTY	64
VIZIO RETURN POLICY	65
Index	68



Opening the Package

Your HDTV and its accompanying accessories are carefully packed in a cardboard carton that has been designed to protect it from transportation damage. Once you have opened the carton, check that your HDTV is in good condition and that all of the contents are included.

The glass surface can easily be scratched or broken, so handle your HDTV gently and never place your HDTV with the glass facing downwards on a surface without protective padding.

IMPORTANT: Save the carton and packing material for future shipping.

Package Contents

- VIZIO VA26L
- VIZIO remote control
- AA batteries for the remote control (2)
- Power cord
- VIZIO screen cleaning cloth
- This user manual
- Quick Setup Guide
- Registration Card
- VIP Services Brochure



Additional certified accessories for your HDTV are sold separately:

- Wall mounts
- High Definition cables
- Extra or replacement remote

VIZIO also offers installation services and extended warranty services for your HDTV.

To purchase or inquire about additional accessories and services for your VIZIO HDTV, visit our web site at www.VIZIO.com or call us toll free at 888-VIZIOCE (888-849-4623)

Caution: Do not apply pressure or throw objects at your HDTV. This may compromise the integrity of the display. The manufacturer's warranty does not cover user abuse or improper installations.



Understanding Basic Controls and Connections

Front Bezel

POWER INDICATOR (VIZIO logo):

- White: On.
- Orange: Off.

REMOTE CONTROL SENSOR:

- Point the remote control directly this sensor for the best response.



Right Side Panel Controls

VOLUME + / -

- Increases or decreases the speaker volume.
- Moves left and right in the OSD menus.

MENU

- Activates the On-Screen Display (OSD).
- If a sub-menu is active, returns to the previous menu level.

CHANNEL + / -

- Steps up or down through the TV channels.
- Moves up and down through controls in the OSD menus.

POWER (⏻)

- Turns your HDTV ON and OFF.

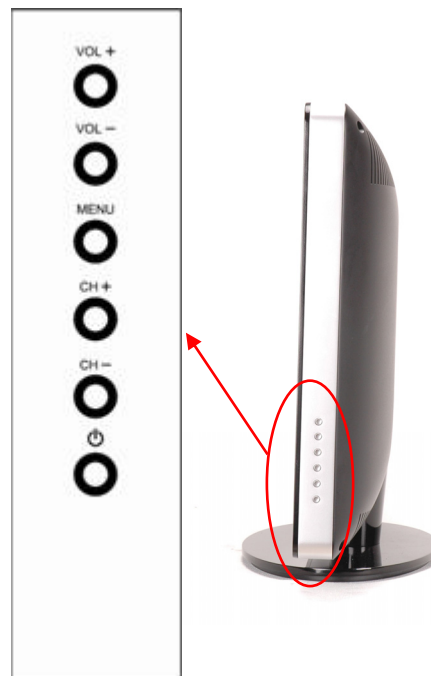

Left Side Panel Controls

AV2

- Connect a VCR or video game to the S-VIDEO port and/or the white, red, and yellow composite ports. S-VIDEO takes priority over the composite connection when both are connected.

HEADPHONE

- Connect your headphones here.

SERVICE

- For factory service only. Use of this input for any purpose other than factory authorized service will void the manufacturer's warranty of this HDTV.



Rear Panel Connections

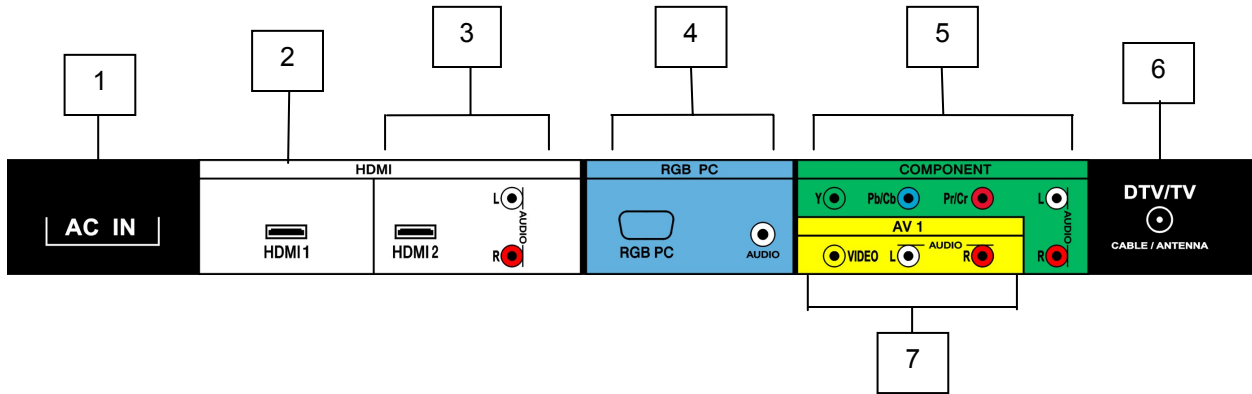

No.	Connection	Description
1	AC IN	Connect the supplied AC power cord.
2	HDMI 1	Connect the primary source for digital video such as a DVD multimedia player or set-top box.
3	HDMI 2	Connect a secondary source for digital video such as a DVD multimedia player or set-top box. For users who want to connect to a DVI enabled device, use a DVI-HDMI cable and connect the Analog Audio output of the device to the L+R AUDIO here. VIZIO Certified HDMI and HDMI-DVI cables are available for purchase from www.VIZIO.com or by calling 888-VIZIOCE (888-849-4623).
4	RGB PC	Connect the video and audio (1/8 in. mini plug stereo connector) from a computer here.
5	COMPONENT (YPb/CbPr/Cr with Audio L/R)	Connect a DVD Player or set top box here. From left to right, use white for left audio and red for right audio, green for Y, blue for Pb (or Cb), and red for Pr (or Cr) inputs.
6	DTV (Cable/Antenna)	Connect to an antenna or digital cable for digital TV. For digital TV stations in your area visit www.antennaweb.org .
7	AV 1	Connect a VCR or video game. Use the white and red connectors to connect the audio from the same source.



VIZIO Remote Control

REMOTE LED – Blinks when remote operates.

POWER – Press to turn your HDTV on from Standby mode. Press it again to return to Standby mode.

NUMBER PAD – Press to select a channel or enter a password.

INPUT – Press repeatedly to cycle through the video inputs.

- (**Dash**) – In DTV mode (antenna), press the number buttons for the main channel, press this button, then press the number button for a digital sub-channel. For example, to select sub-channel 2 of main channel 28, press 2, press 8, press this button, then press 2.

CH (+ or -) – Press to step up or down through the TV channels.

LAST – Press to recall the previously viewed channel.

MUTE – Press to turn the sound on and off.

VOL (+ or -) – Press to increase or decrease the speaker volume.

MENU – Press to launch the On-Screen Display (OSD) menu.

INFO – Press to display the video image and system information.

GUIDE – Press to display program information.

NOTE: *This function is only available with DTV.*

EXIT – Press to exit the On-Screen Display (OSD) menus.

 - After pressing **MENU**, navigate through the OSD and adjust options, then press **OK** to select your chosen option.



WIDE – Cycle through the available screen formats (Wide, Normal, and Panoramic). Note: in RGB/PC mode the options are 4:3 and 16:9.

SLEEP – Press to select the sleep options from 30 to 120 minutes.

MTS – Select the MTS option (Stereo, SAP, or Mono). In DTV mode, select alternate audio channels, where available.

CC – select the Closed Caption mode (OFF, CC1, CC2, CC3, or CC4).

TV – Press to select TV mode.

AV – Press repeatedly to cycle between AV1 and AV2 inputs.

COMPONENT – Press to select the Component input.

HDMI – Press repeatedly to cycle between HDMI 1 and HDMI 2 inputs.

RGB – Press to select an RGB component such as a computer.

MODE – Select the picture mode (Custom, Standard, Movie, or Game).

The following buttons are disabled because your HDTV does not have those features:

- FREEZE
- PIP
- PIP CH
- AUDIO
- PIP INPUT
- PIP SIZE
- SWAP



Remote Control Range

- The effective range of the remote control is approximately 26 feet (8 meters) from the front of the receiver window and 13 feet (4 meters) when 30° to the left and right, 20° up and down.
- Point the remote control at the remote control sensor on the front of your HDTV to send commands.
- Do not place any obstacles between the remote control and the remote control sensor.

VIZIO Remote Control Precautions

- Keep the remote control dry and away from heat sources. Avoid humidity.
- If your HDTV responds erratically to the remote control or does not respond at all, check the batteries. If the batteries are low or exhausted, replace them with fresh batteries.
- When not using the remote control for a long period of time, remove the batteries.
- Do not take the batteries apart, heat them, or throw them into a fire.
- Do not subject the remote control to undue physical stress, such as striking or dropping it.
- Do not attempt to clean the remote control with a volatile solvent. Wipe it with a clean, damp cloth.
- Do not mix old and new batteries or different types of batteries.









Setting Up Your HDTV

- Read this user manual carefully before installing your HDTV.
- The power consumption of your HDTV is about 105W. Use the included power cord. When an extension cord is required, use one with the correct power rating. The cord must be grounded and the grounding feature must not be compromised.
- Your HDTV should be installed on a flat surface to avoid tipping.
- For proper ventilation, you must allow space between the back of your HDTV and the wall.
- If you want to mount your HDTV on the wall, see “ Wall Mounting your HDTV” for additional information.
- Avoid installing your HDTV in places with high humidity, dust, or smoke so you do not shorten the service life of the electronic components.
- Install your HDTV in a level, landscape orientation, with the VIZIO logo at the bottom to prevent poor ventilation and excessive component damage.

VIZIO offers professional installation services. Contact VIZIO for more information on these services at 888-VIZIOCE (888-849-4623) or www.VIZIO.com.

Choosing a video connection

Your HDTV has six different ways to connect your video equipment from a basic connection to the most advanced for digital displays.

Connection Quality (type)	Connector	Rear & Side Panel Color Code	Description
Best (digital)		White (Rear)	HDMI (High-Definition Multimedia Interface). HDMI is the first and only industry-supported, uncompressed, all-digital audio/video interface. HDMI connects an AV device (such as a set-top box, DVD player, or A/V receiver) to your HDTV using one cable to carry both the audio and video.
Best (digital) ----- Good (analog)		Black (Rear)	DTV Coaxial RF. For digital programming, this input takes advantage of high-definition content. ----- TV Coaxial RF. The connection for standard NTSC TV using antenna or cable.
Best (analog)		Blue (Rear)	RGB PC (VGA). This is most commonly used connecting a computer.
Better (analog)		Green (Rear)	Component. The video signal is separated into three signals, one containing the black-and-white information and the other two containing the color information. This enhancement over S-Video takes advantage of the superior picture provided by progressive scan DVD players and HDTV formats.
Good (analog)		Orange (Side)	S-Video. The video signal is separated into two signals, one containing the black-and-white information and the other containing the color information. Separating the color in this way avoids ‘cross color’ effects where closely spaced black and white lines are erroneously displayed in color. It also enables text to be displayed more sharply.
Good (analog)		Yellow (Rear) Orange (Side)	Composite. The video signal is carried through the yellow jack and the audio is carried through the white and red jacks. This is the most commonly used video connection.

NOTE: For more information refer to the Quick Start Guide.



Connecting Your Cable or Satellite Box

You have four options for connecting your cable or satellite box to your HDTV: HDMI, Component, Composite, or Coax (RF). Based on your home theater configuration, you can decide which option is the right one for you. Refer to your set-top box user manual for more information about the video output requirements or consult your cable or satellite operator.

Using HDMI (Best)

Cable and satellite boxes that have a HDMI digital interface should be connected to the HDMI input on your HDTV for optimal results.

NOTE: To maintain the display quality, use a VIZIO certified HDMI cable. Length is available up to up to 32.8 feet (10 meters). See www.VIZIO.com or call 1-888-VIZIOCE (1-888-849-4623) for details.

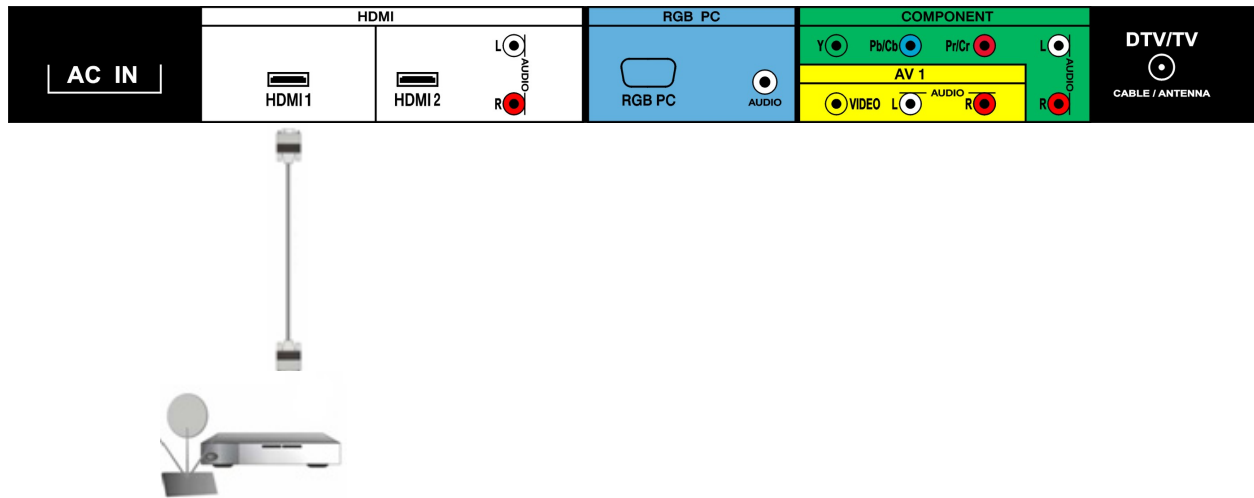

1. Turn off your HDTV and set-top box.
2. Connect the HDMI cable from the from the HDMI OUT jack on your set-top box to an available **HDMI** jack on the back or side of your HDTV.
3. Turn on your HDTV and set-top box.
4. Press **HDMI** repeatedly on the remote control to view the content. You can also press **INPUT** on the remote control.

NOTE:

- If HDMI1 is being used, connect to the HDMI2 port instead.
- The HDMI input on the TV supports High-bandwidth Digital Content Protection (HDCP). HDCP encrypts the transmission between the video source and the digital display for added security and protection.



HDMI Connections for Cable or Satellite Boxes with DVI

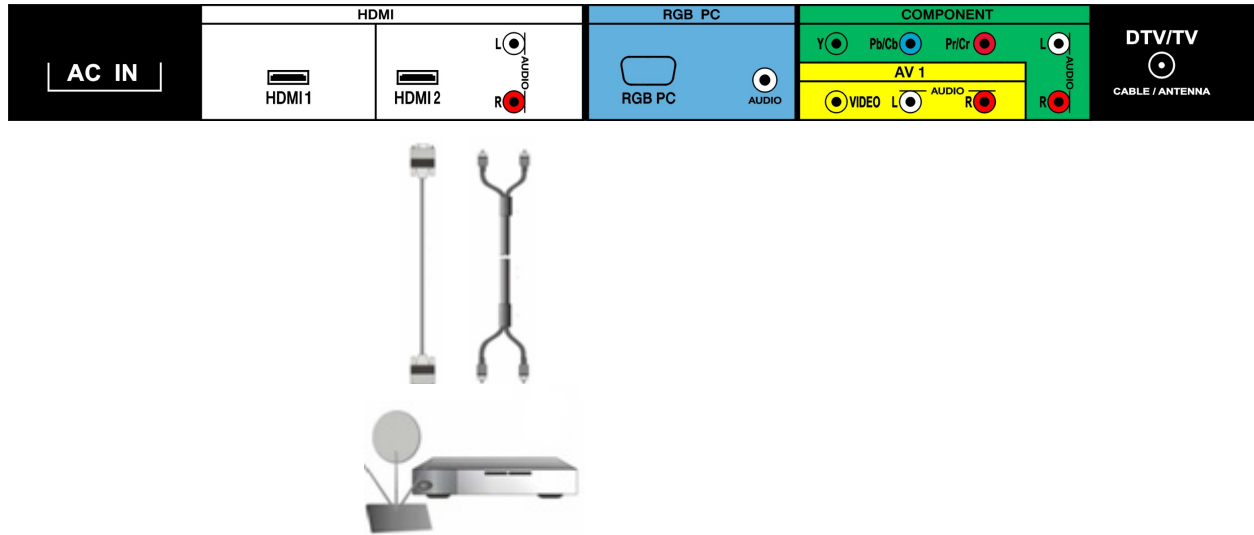

1. Turn off your HDTV and set-top box.
2. Using an HDMI-DVI cable, connect the DVI end to the DVI OUT jack on your set-top box and the HDMI end to the **HDMI 2** jack on the back of your HDTV.
3. Connect the audio cable (white and red connectors) from the DVI audio output jacks on the set-top box to the adjacent **HDMI 2** audio jacks on the back of your HDTV.
4. Turn on your HDTV and set-top box.
5. Press **HDMI** repeatedly on the remote control to view the content. You can also press **INPUT** on the remote control.

NOTE:

- If HDMI2 is being used, connect to the HDMI1 port instead.
- The HDMI input on the TV supports High-bandwidth Digital Content Protection (HDCP). HDCP encrypts the transmission between the video source and the digital display for added security and protection.



Using Component Video (Better)

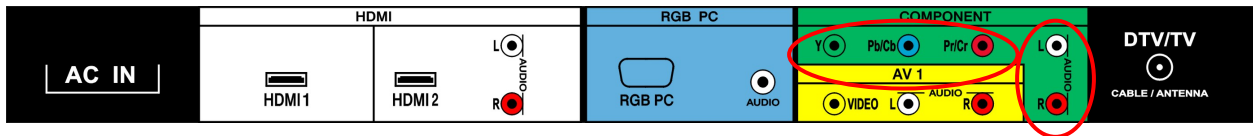

1. Turn off your HDTV and set-top box.
2. Connect the component cables (green, blue, and red) from your set-top box to an available set of **COMPONENT** jacks on the back of your HDTV.
3. Connect the audio cables (white and red) from your set-top box to the adjacent **COMPONENT L** and **R Audio** jacks on the back or side of your HDTV.
4. Turn on your HDTV and set-top box.
5. Press **COMPONENT** on the remote control to view the content. You can also press **INPUT** on the remote control.

Using S-Video (Better)

1. Turn off your HDTV and set-top box.
2. Connect the S-VIDEO cable from your set-top box to the **S-VIDEO** jack on the side of your HDTV.
3. Connect the audio cables (white and red) on your set-top box to the corresponding **L** and **R AUDIO** jacks on the side of your HDTV.
4. Turn on your HDTV and set-top box.
5. Press **AV** on the remote control to view the content. You can also press **INPUT** on the remote control.

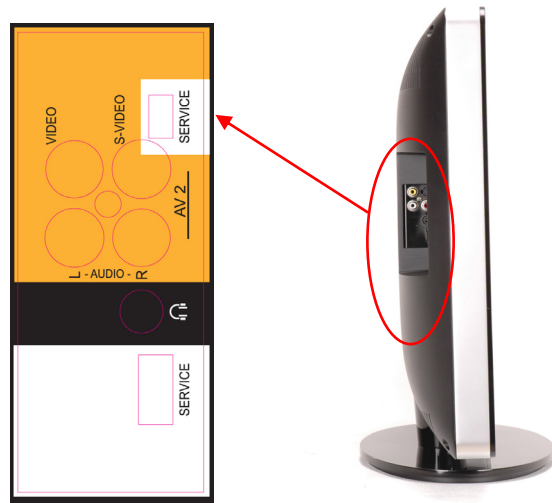

Using Composite Video (Good)

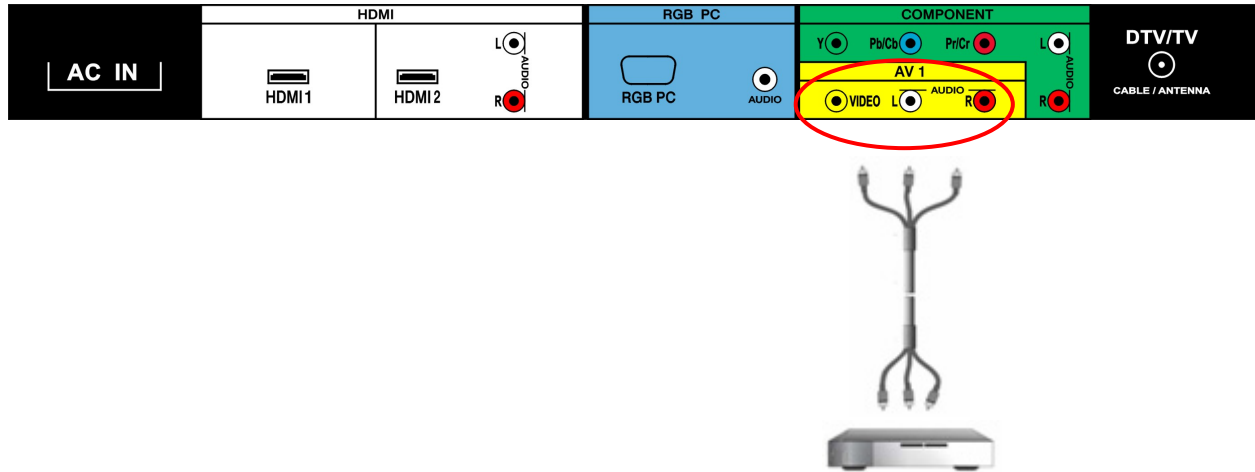

1. Turn off your HDTV and set-top box.
2. Connect the video cable (yellow) from your set-top box to the **AV 1** jack (yellow) on the back of your HDTV.
3. Connect the audio cables (white and red) on your set-top box to the corresponding **L** and **R AUDIO** jacks on the back of your HDTV.
4. Turn on your HDTV and set-top box.
5. Press **AV** on the remote control to view the content. You can also press **INPUT** on the remote control.

NOTE: If AV1 is being used, connect to the AV2 (side) port instead.

Using Coaxial (Antenna) (Good)

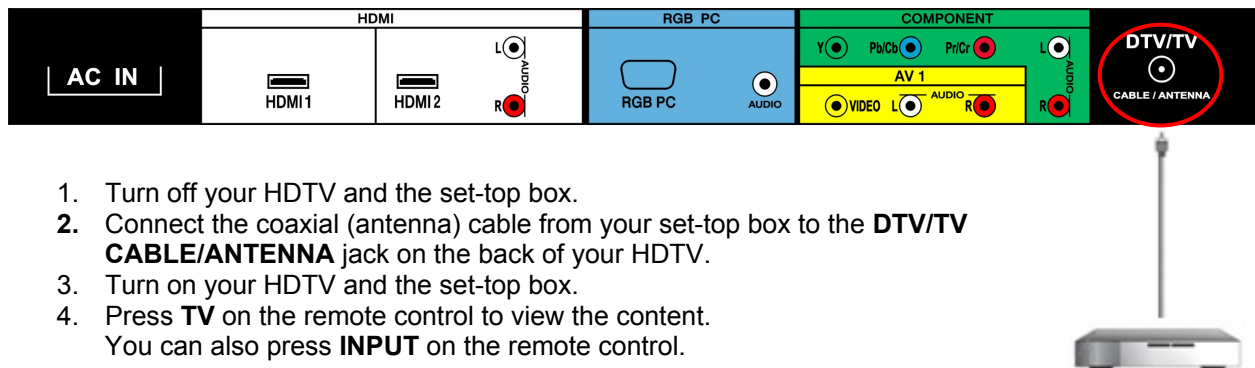

1. Turn off your HDTV and the set-top box.
2. Connect the coaxial (antenna) cable from your set-top box to the **DTV/TV CABLE/ANTENNA** jack on the back of your HDTV.
3. Turn on your HDTV and the set-top box.
4. Press **TV** on the remote control to view the content. You can also press **INPUT** on the remote control.



Connecting Coaxial (RF)

Using Your Antenna or Digital Cable for Standard TV or DTV

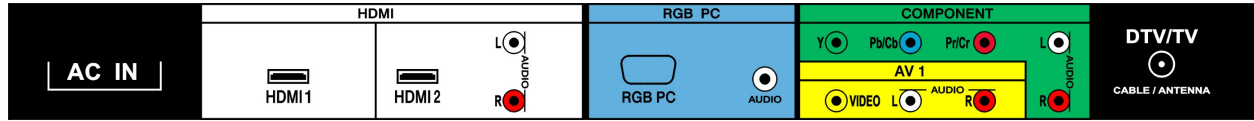

1. Turn off your HDTV.
2. Connect the coaxial (RF) cable from your antenna or digital cable to the **DTV/TV CABLE/ANTENNA** jack on the back of your HDTV.
3. Turn on your HDTV.
4. Press **TV** on the remote control to view digital TV content or press **TV** to view standard TV content. You can also press **INPUT** on the remote control.

NOTE:

- *Not all digital TV broadcasts are high definition (HD). Refer to the program guides, or consult your cable, satellite or TV station operator.*
- *Digital broadcasts are not available in all areas. Refer to www.antennaweb.org for detailed information.*
- *Make sure the antenna and coaxial cable are correctly grounded.*

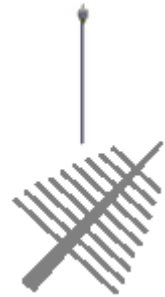

Using the Antenna or Cable through Your VCR

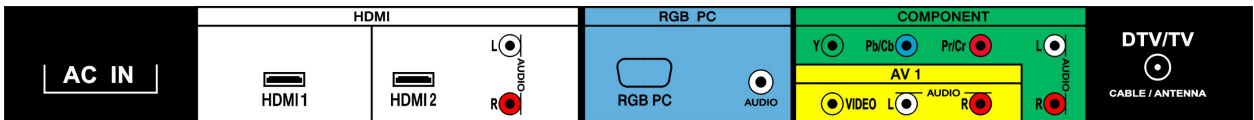

1. Turn off your HDTV and VCR.
2. Connect the antenna output jack on the back of your VCR to the **DTV/TV CABLE/ANTENNA** jack at the back of your HDTV.
3. Turn on your HDTV and VCR.
4. Press **TV** on the remote control. You can also press **INPUT** on the remote control.

NOTE: *If you have an off-air antenna or cable TV, connect it to the antenna in jack on the back of your VCR.*



Connecting Your DVD Player

You have several options for connecting your DVD player to your HDTV: HDMI, Component, S-Video, and Composite (AV). Based on your home theater configuration, you can decide which option is the right one for you. Refer to your DVD player user manual for more information about the video output requirements.

Using HDMI (Best)

For optimal results, DVD players that have a digital interface such as HDMI should be connected to the HDMI input on your HDTV.

NOTE: To maintain the display quality, use a VIZIO certified HDMI cable. Length is available up to 32.8 feet (10 meters). See www.VIZIO.com or call 1-888-VIZIOCE (1-888-849-4623) for details.

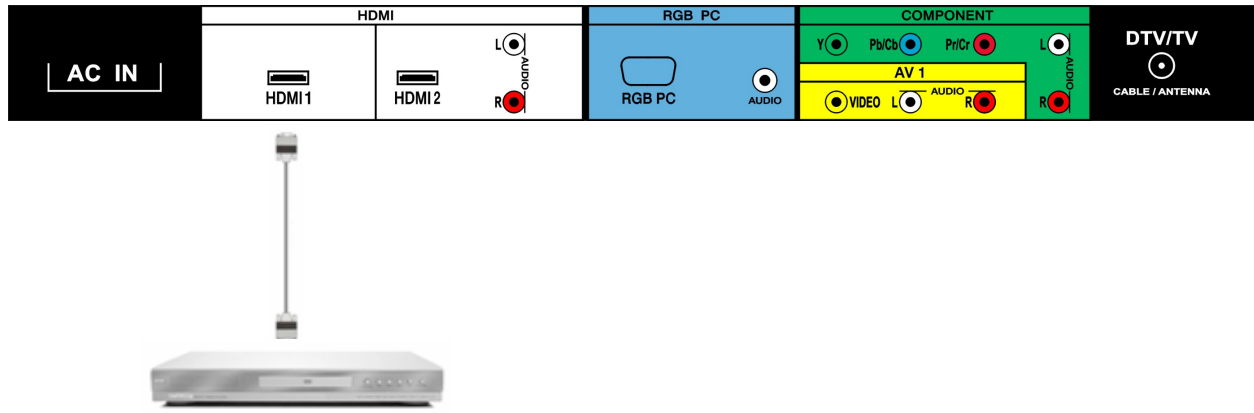

1. Turn off your HDTV and DVD player.
2. Connect the HDMI cable from your DVD player to an available **HDMI** jack on the back or side of your HDTV.
3. Turn on your HDTV and your DVD player.
4. Press **HDMI** repeatedly on the remote control to view the content. You can also press **INPUT** on the remote control.

NOTE:

- If HDMI1 is being used, connect to the HDMI2 port instead.



HDMI Connections for DVD Players with DVI

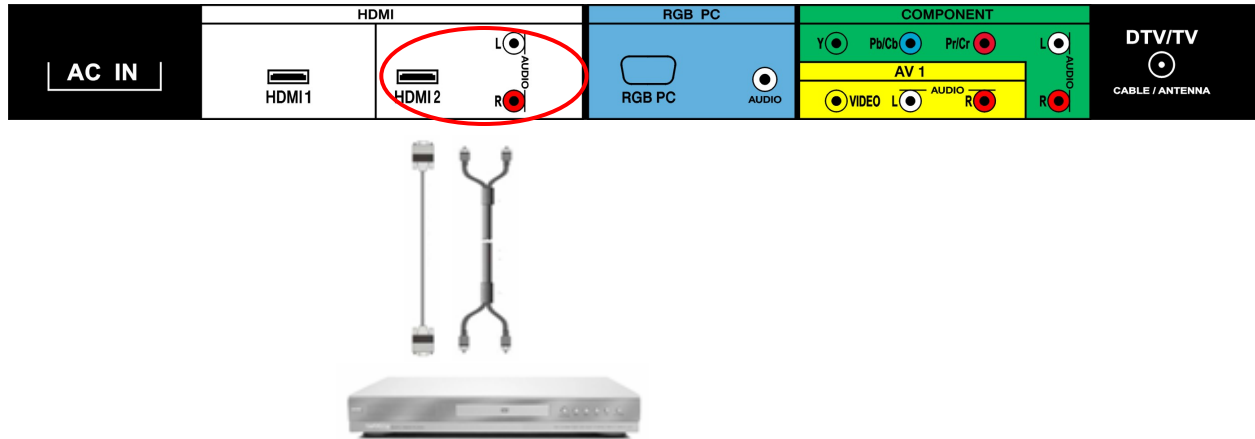

1. Turn off your HDTV and DVD Player.
2. Using an HDMI-DVI cable, connect the DVI end to the DVI Out jack on your DVD player and the HDMI end to the **HDMI 2** jack on the back of your HDTV.
3. Connect the audio cables (white and red) from the DVI audio output jacks on the DVD player to the adjacent **HDMI 2 L** and **R AUDIO** jacks on the back of your HDTV.
4. Turn on your HDTV and set-top box.
5. Press **HDMI** repeatedly on the remote control to view the content. You can also press **INPUT** on the remote control.

NOTE:

- If HDMI2 is being used, connect to the HDMI1 port instead.

Using Component Video (Better)

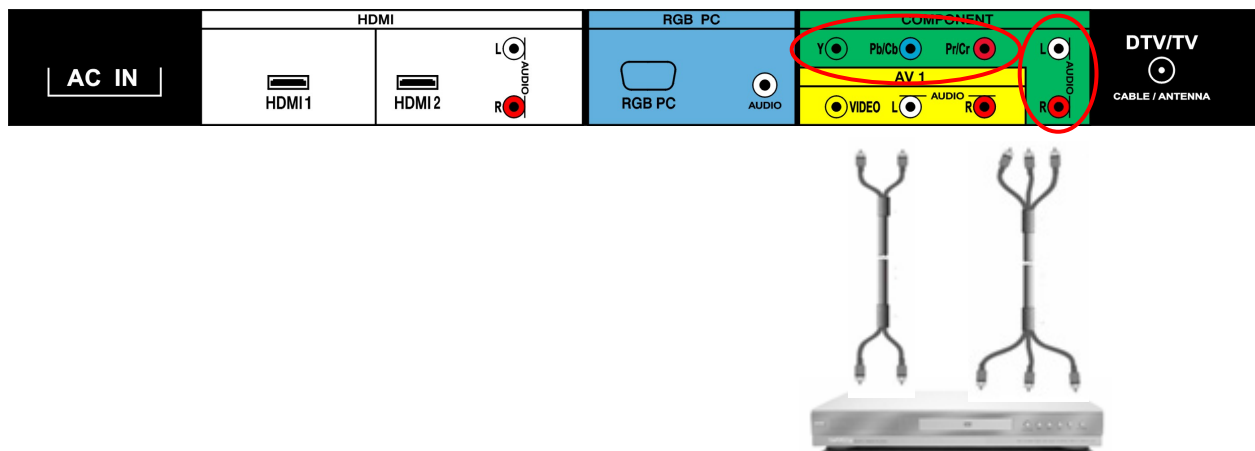

1. Turn off your HDTV and DVD player.
2. Connect the component cable (green, blue, and red) from your DVD player to an available set of **COMPONENT** jacks on the back or side of your HDTV.
3. Connect the audio cables (white and red) from your DVD player to the **COMPONENT L** and **R AUDIO** jacks on the back or side of your HDTV.
4. Turn on your HDTV and DVD player.
5. Press **COMPONENT** on the remote control to view the content. You can also press **INPUT** on the remote control.



Using S-Video (Better)

1. Turn off your HDTV and set-top box.
2. Connect the S-VIDEO cable from your set-top box to the **S-VIDEO** jack on the side of your HDTV.
3. Connect the audio cables (white and red) on your set-top box to the corresponding **L** and **R AUDIO** jacks on the side of your HDTV.
4. Turn on your HDTV and set-top box.
5. Press **AV** on the remote control to view the content. You can also press **INPUT** on the remote control.



Using Composite (AV) Video (Good)

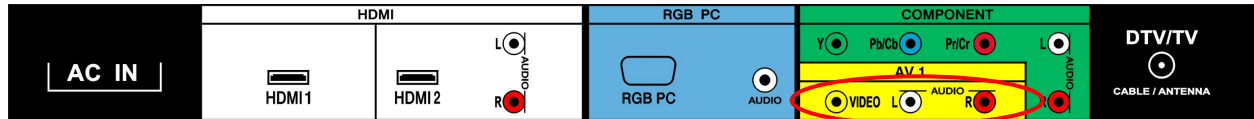

1. Turn off your HDTV and DVD player.
2. Connect the Video cable (yellow) from your DVD player to the **AV/S-VIDEO** jack on the back of your HDTV.
3. Connect the audio cables (white and red) on your DVD player to the **AV/S-VIDEO L** and **R AUDIO** jacks on the back of your HDTV.
4. Turn on your HDTV and DVD Player.
5. Press **AV** on the remote control to view the content. You can also press **INPUT** on the remote control.

NOTE: If AV1 is being used, connect to the AV2 (side) port instead.



Connecting Your VCR or Video Camera

1. Turn off your HDTV and set-top box.
2. Connect the S-VIDEO cable from your set-top box to the **S-VIDEO** jack on the side of your HDTV.
3. Connect the audio cables (white and red) on your set-top box to the corresponding **L** and **R AUDIO** jacks on the side of your HDTV.
4. Turn on your HDTV and set-top box.
5. Press **AV** on the remote control to view the content. You can also press **INPUT** on the remote control.

NOTE: Refer to your VCR or video camera user manual for more information about the video output requirements.



Connecting a Computer

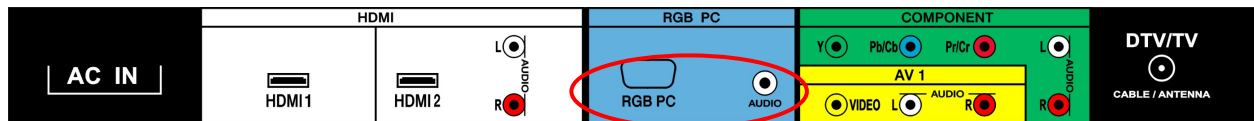

1. Turn off your HDTV and computer.
2. Connect the VGA cable from your computer to the **RGB PC** jack on the back of your HDTV.
3. Connect the 1/8-inch audio cable from your computer to the **RGB PC Audio** jack on the back of your HDTV.
4. Turn on your HDTV and computer.
5. Press **RGB** on the remote control or side of your HDTV.

NOTE:

- For better picture quality when connecting a computer through **RGB PC** jack, set your video resolution to 1366x768 at 60Hz.
- Refer to your computer user manual for more information about the video output requirements of the computer.
- A RGB (VGA) cable and audio cable are not included and can be purchased at an electronics store.



Wall Mounting your HDTV

Your HDTV can be mounted on the wall for viewing. If you choose to mount your HDTV on the wall, follow the instructions below.

1. Remove the base:
 - a. Disconnect the cables from your HDTV.
 - b. Place your HDTV face down on a soft, flat surface to prevent damage to the screen.
 - c. Remove the thumbscrew on the base, then remove the base.
 - d. Remove the neck cover.
 - e. Remove the four (4) screws holding the neck to your HDTV.



2. Mount your HDTV on the wall:
 - a. Attach your HDTV to a wall mount (sold separately) using the mounting holes in the back panel of your HDTV.
 - b. Read the instructions that came with your specific wall mount to properly hang your HDTV.

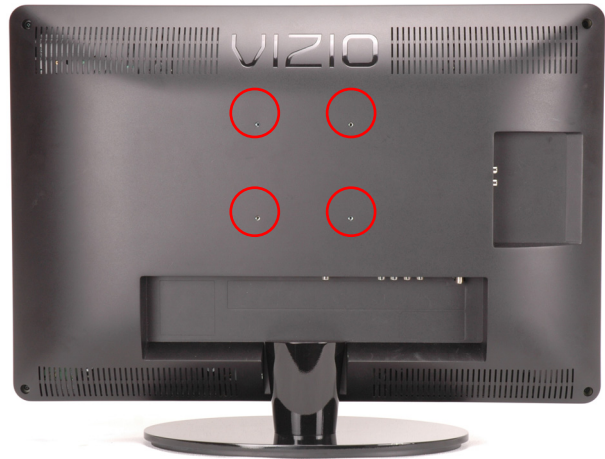

Additional Information:

Mounting hole pitch	100mm horizontally 100mm vertically
Screw type	Metric M4 8mm long 0.7mm pitch
Screw length	Depends on the thickness of the wall mount plate. VIZIO brackets come with different length screws.

To find the perfect mount for your HDTV, browse VIZIO's certified wall mount selection at www.VIZIO.com or call 888-VIZIOCE (888-849-4623).



Inserting the remote control batteries

1. Remove the battery compartment cover on the back of the remote control.
2. Insert two AA batteries (included) into the remote control, making sure you match the (+) and (-) symbols on the batteries with the (+) and (-) symbols inside the battery compartment.
3. Re-attach the battery compartment cover.

Precautionary Tips for Inserting the Batteries:

- Only use the specified AA batteries.
- Do not mix new and old batteries. This may result in cracking or leakage that may pose a fire risk or lead to personal injury.
- Inserting the batteries incorrectly may also result in cracking or leakage that may pose a fire risk or lead to personal injury.
- Dispose of the batteries in accordance with local laws and regulations.
- Keep the batteries away from children and pets.



Using your HDTV the first time

1. Connect audio and video cables from the desired components to your HDTV as described in "Connecting Devices."
2. Connect one end of the power cord to the power cord connector on the back of your HDTV. Then connect the other end into a power outlet.
3. Press  on the remote control or on the side of your HDTV, then press **TV** to select TV mode. The *Initial Setup Welcome* screen opens on your HDTV.

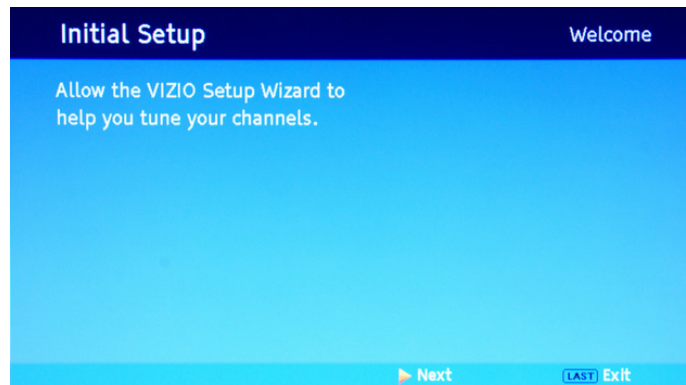

4. Press  on the remote control. The *Language* screen opens.

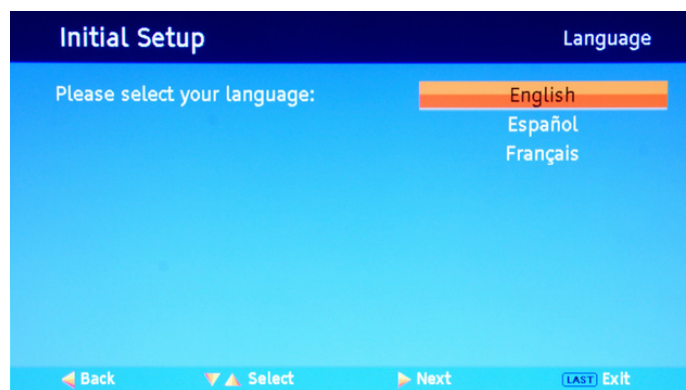

- 5. Press ▲ or ▼ to select your language, then press ►. The *Tuner* screen opens.

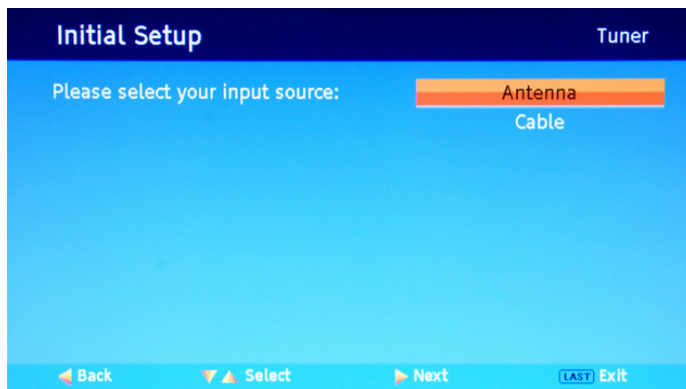

- 6. If you are using a cable or satellite set-top box, press **LAST** to skip to the channel scan and go to Step 9. Otherwise, continue with Step 7 below.

- 7. Press ▲ or ▼ to select your input source (Antenna or Cable), then press ►. The *Channel Scan* screen opens.

NOTE: Select *Cable* only if you receive your cable service without a set-top box.

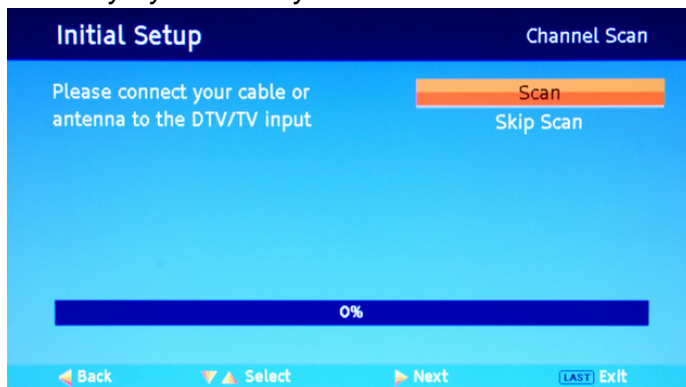

8. Press ▲ or ▼ to select the desired channel scan process, then press ►. The *Channel Scan progress* screen opens if you selected *Scan*. Otherwise the *Complete* screen opens.

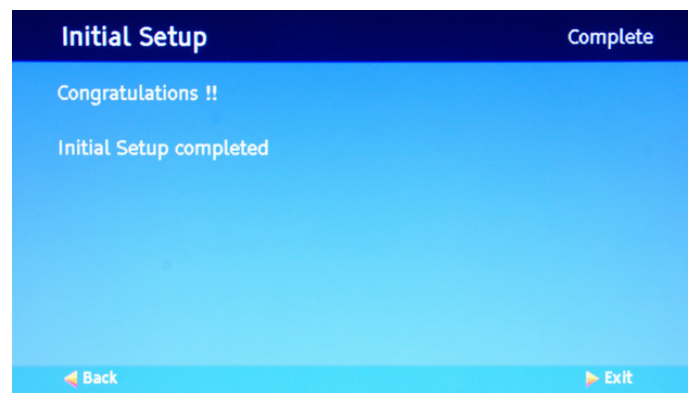
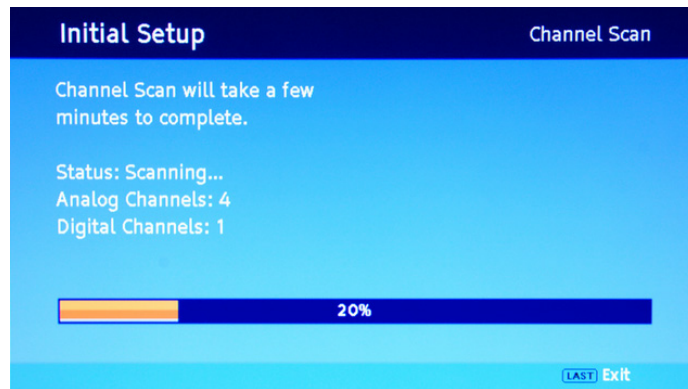

9. When the *Complete* screen opens, press ► to exit.

NOTE: DTV digital broadcast is not available in all areas. Refer to www.antennaweb.org to get information about availability in your area, antenna types, and in which direction to point your antenna. The channel availability through cable depends on which channels your cable operator supplies in Clear QAM. Consult your cable operator for more information.



Selecting Inputs

Input
TV
COMP
AV1
AV2
HDMI1
HDMI2
RGB

1. Press **INPUT** on the remote to select the input source that matches the connection you made on the back of your HDTV. Repeated presses of **INPUT** cycles you through the options.
2. Turn on your component (cable box, VCR, satellite receiver, DVD player, etc.). You should see a picture on your HDTV. If you do not see a picture, press **INPUT** repeatedly until you do see a picture.

NOTE: If the selected input is RF, your HDTV needs to be on either channel 3 or 4 to match the channel on the VCR, cable box, external TV tuner or satellite receiver. Refer to the User's Manual of your equipment for details.

NOTE: Your HDTV will display the television station or program selected by the cable box, VCR, external tuner, or satellite receiver. Use the remote control that came with that component to change programs or channels. If the service being used is the one which setup includes a box with two outputs for two different (distant) rooms, then scanning channels will help you to find the signal. Be aware that the channel to be selected varies from provider to provider. You may have to call your provider to get the specific channel when using your HDTV. Some examples of these channels are 105, 106, 115, and 116.



Fine-tuning the picture

1. Press **MENU** on the remote control. The *Picture* menu opens.



2. Press **▲** or **▼** to select *Color Temperature*, then press **▶**. The *Color Temperature* menu opens.



3. Press **◀** or **▶** to change select *Normal*, then press **MENU** twice to return to the *Picture* menu.



4. Press **▲** or **▼** to select *Picture Mode*.
5. Press **▶** to select *Standard*.
6. Press **MENU** to exit the menu.



Using the Program Guide

1. Press **GUIDE** on the remote to display program information for the channel you are watching. The live program content is displayed in a small window in the lower left corner.
2. Press **GUIDE** twice to display the Electronic Programming Guide.
3. Press ◀ or ▶ to scroll up or down the channels.
4. Each time you pause at a channel, the program list updates with the program schedule for the channel and the window shows the live program for that channel.
5. Press **GUIDE** to exit the Electronic Programming Guide or wait for it to disappear automatically.

Displaying the Information Banner

When you change channels or inputs, an information banner displays the status of your HDTV.

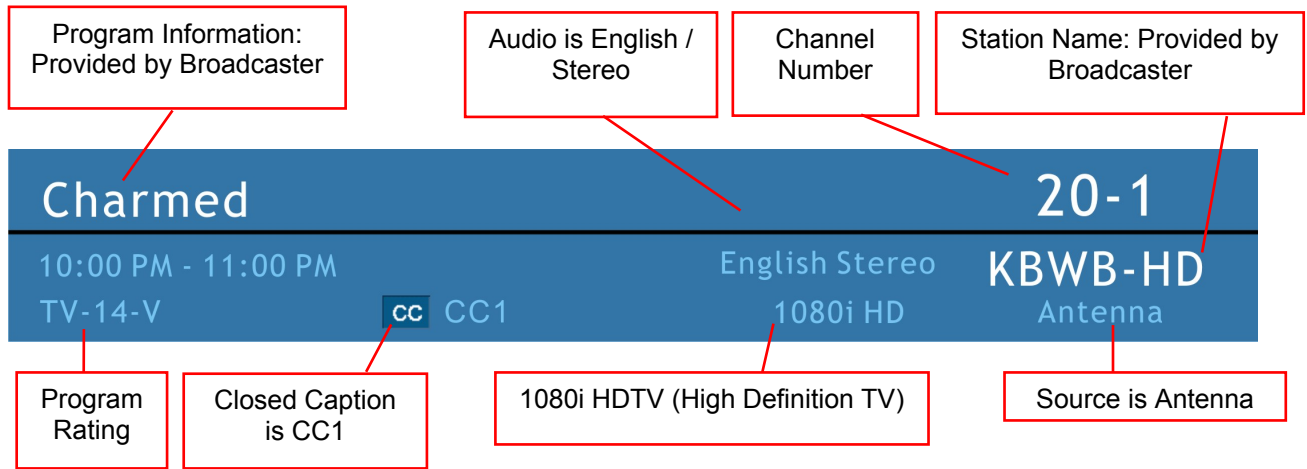

Using the On-Screen Display (OSD)

The remote control or the control buttons on the side of your HDTV control the function settings. The On-Screen Display (OSD) lets you adjust the contrast, brightness, and other settings. Changes are saved even when you turn off your HDTV. The OSD consists of these menu options:



NOTE: The main menu options may vary depending on the selected input source.

1. Press **MENU** on the remote control or the side of your HDTV. The *Picture* menu opens.



2. Press **◀** or **▶** on the remote control or **VOL +** or **VOL -** on the side of your HDTV to select an option.
3. Press **▲** or **▼** on the remote control or **CH +** or **CH -** on the side of your HDTV to select a sub-menu option.
4. Press **▶** on the remote control or **VOL -** on the side of your HDTV to adjust the item.
5. Press **OK** when finished making adjustments.
6. Press **MENU** to return to the previous screen or repeatedly to exit the OSD.

NOTE: OSD items that are not available for adjustment are shown with a box with a red X symbol.

Using a Cable or Satellite Remote Control

You can program your cable or satellite remote control to control your HDTV.

To use a cable or satellite remote control to control your HDTV:

1. Refer to your cable or satellite user guide for information on how to program the remote.
2. If your cable or satellite remote uses a 5-digit code (most Direct TV units), use code **11758** or **10178**.

OR

If your cable or satellite remote uses a 4-digit code, use code **1758** or **0178**.

OR

If your cable or satellite remote uses a 3-digit code (Echostar or Dish Network), use code **627**.

NOTE: Some buttons may not function as expected on your cable or satellite remote control. Typically power, volume, and mute will work.



Advanced Settings

Adjusting the Picture Settings

When viewing DTV / TV or an HDMI, Component, or AV source, the following picture adjustment OSD screens are available when you press **MENU** on the remote control. The source you are viewing is displayed in orange text in the bottom left-hand corner of the OSD.

Picture Mode

1. Press **MENU** on the remote control or the side of your HDTV. The *Picture* menu opens.



2. Press **▲** or **▼** to select *Picture Mode*.
3. Press **◀** or **▶** to select one of the available options: *Custom, Standard, Movie, Game*.
4. Press **EXIT** to exit the OSD.



Backlight

The Backlight adjusts the lamp current and affects the overall brilliance of the picture. It does not affect the Brightness (black level) or Contrast (white level) of the picture.

1. Press **MENU** on the remote control or the side of the TV. The *Picture* menu opens.



2. Press **▲** or **▼** to select *Backlight*.
3. Press **▶** to start adjusting the brightness of the backlight. The menu page disappears and is replaced by a Backlight Indicator Bar.



4. Press **◀** or **▶** to adjust the level.
5. Press **EXIT** to exit the OSD.

Brightness

Brightness adjusts the black levels in the picture. If the brightness is too low you will not be able to see the detail in darker parts of the picture and if the brightness is too high the picture will look washed out.

1. Press **MENU** on the remote control or the side of your HDTV. The *Picture* menu opens.



2. Press **▲** or **▼** to select *Brightness*.
3. Press **▶** to start adjusting *Brightness*. The menu page will disappear and be replaced by a *Brightness* Indicator Bar.



4. Press **◀** or **▶** to adjust the level.
5. Press **EXIT** to exit the OSD.



Contrast

Contrast adjusts the white levels in the picture. If the contrast is too low the picture will look washed out and if the contrast is too high you will not be able to see any detail in the bright parts of a picture.

1. Press **MENU** on the remote control or the side of your HDTV. The *Picture* menu opens.



2. Press **▲** or **▼** to select *Contrast*.
3. Press **▶** to start adjusting *Contrast*. The menu page disappears and is replaced by a *Contrast Indicator Bar*.



4. Press **◀** or **▶** to adjust the level.
5. Press **EXIT** to exit the OSD.

Color

The Color setting adjusts the amount of color in the picture.

1. Press **MENU** on the remote control or the side of your HDTV. The *Picture* menu opens.



2. Press **▲** or **▼** to select *Color*.
3. Press **▶** to start adjusting *Color*. The menu page disappears and is replaced by a *Color Indicator Bar*.



4. Press **◀** or **▶** to adjust the level.
5. Press **EXIT** to exit the OSD.



Tint

1. Press **MENU** on the remote control or the side of your HDTV. The *Picture* menu opens.



2. Press **▲** or **▼** to select *Tint*.
3. Press **▶** to start adjusting *Tint*. The menu page disappears and is replaced by a *Tint* Indicator Bar.



4. Press **◀** or **▶** to adjust the level.
5. Press **EXIT** to exit the OSD.

Sharpness

The Sharpness setting adjusts the sharpness of the picture.

1. Press **MENU** on the remote control or the side of your HDTV. The *Picture* menu opens.



2. Press **▲** or **▼** to select *Sharpness*.
3. Press **▶** to start adjusting *Sharpness*. The menu page disappears and is replaced by a *Sharpness* Indicator Bar.



4. Press **◀** or **▶** to adjust the level.
5. Press **EXIT** to exit the OSD.



Color Temperature

This feature lets you adjust your HDTV color temperature.

1. Press **MENU** on the remote control or the side of your HDTV. The *Picture* menu opens.



2. Press **▲** or **▼** to select *Color Temperature*, then press **▶**. The *Color Temperature* menu opens.



3. Press **◀** or **▶** to select *Normal*, *Warm*, *Cool*, or *Custom*.
4. If you choose *Custom*, you can adjust the gain and offset of each color individually.
 - a. Press **▲** or **▼** to select the color you wish to adjust.
 - b. Press **◀** or **▶** to adjust the color.
5. Press **EXIT** to exit the OSD.



Advanced Video

1. Press **MENU** on the remote control or the side of your HDTV. The *Picture* menu opens.



2. Press **▲** or **▼** to select *Advanced Video*, then press **▶**. The *Advanced Video* menu opens.



DNR

DNR (Dynamic Noise Reduction) diminishes picture artifacts caused by the digitizing of moving images.

1. Press **▼** to select *DNR*.
2. Press **◀** or **▶** to choose *Off*, *Low*, *Medium*, or *Strong*.
3. Press **EXIT** to exit the OSD.

Black Level Extender

Black Level Extender extends grey levels to black to improve contrast.

1. Press **▼** to select *Black Level Extender*.
2. Press **◀** or **▶** to choose *Off* or *On*.
3. Press **EXIT** to exit the OSD.

White Peak Limiter

White Peak Limiter limits excessive white in bright areas of the picture.

1. Press **▼** to select *White Peak Limiter*.
2. Press **◀** or **▶** to choose *Off* or *On*.
3. Press **EXIT** to exit the OSD.



CTI

Select CTI (Chrominance Transient Improvement) to reduce time transitioning from one color to another. The effect will be seen as sharpening the border between colors.

1. Press ▼ to select *CTI*.
2. Press ◀ or ▶ to choose *Off*, *Low*, *Medium*, or *Strong*.
3. Press **EXIT** to exit the OSD.

Flesh Tone

Adjust flesh tones of the picture. This may result in a more pleasing production of sky and flesh colors.

1. Press ▼ to select *Flesh Tone*.
2. Press ◀ or ▶ to choose *Off* or *On*.
3. Press **EXIT** to exit the OSD.

Adaptive Luma

Large areas of darkness in a picture results in a lower luma level and the overall picture looks dark. Activation of this feature raises the luma level to counteract this effect.

1. Press ▼ to select *Adaptive Luma*.
2. Press ◀ or ▶ to choose *Off* or *On*.
3. Press **EXIT** to exit the OSD.



Adjusting the Audio Settings

When viewing a DTV / TV or an HDMI, Component, AV, or PC source, the following audio adjustment OSD screens are available when you press **MENU** on the remote control. The source you are viewing is displayed in orange text in the bottom left-hand corner of the OSD.

Volume

1. Press **MENU** on the remote control or the side of your HDTV, then press **▶** repeatedly until the *Audio* menu opens.



2. Press **▲** or **▼** to select *Volume*.
3. Press **▶** to start adjusting *Volume*. The menu page disappears and is replaced by a *Volume* Indicator Bar.



4. Press **◀** or **▶** to adjust the level.
5. Press **EXIT** to exit the OSD.

Bass

1. Press **MENU** on the remote control or the side of your HDTV, then press **▶** repeatedly until the *Audio* menu opens.



2. Press **▲** or **▼** to select *Bass*, then press **◀** or **▶** to start adjusting bass.
3. Press **EXIT** to exit the OSD.



Treble

1. Press **MENU** on the remote control or the side of your HDTV, then press **▶** repeatedly until the *Audio* menu opens.



2. Press **▲** or **▼** to select *Treble*, then press **◀** or **▶** to start adjusting treble.
3. Press **EXIT** to exit the OSD.

Balance

1. Press **MENU** on the remote control or the side of your HDTV, then press **▶** repeatedly until the *Audio* menu opens.



2. Press **▲** or **▼** to select *Balance*, then press **◀** or **▶** to start adjusting balance.
3. Press **EXIT** to exit the OSD.



Surround

1. Press **MENU** on the remote control or the side of your HDTV, then press **▶** repeatedly until the *Audio* menu opens.



2. Press **▲** or **▼** to select *Surround*, then press **◀** or **▶** to choose *On* or *Off*.
3. Press **EXIT** to exit the OSD.

Speakers

You may want to turn-off the internal TV speakers when listening to the audio through your home theater system.

1. Press **MENU** on the remote control or the side of your HDTV, then press **▶** repeatedly until the *Audio* menu opens.



2. Press **▲** or **▼** to select *Speakers*.
3. Press **◀** or **▶** to choose *On* or *Off*.
4. Press **EXIT** to exit the OSD.



Lip Sync

Lip Sync is designed to adjust the audio of the program being viewed so that it matches the movement of the lips of someone talking on the screen.

1. Press **MENU** on the remote control or the side of your HDTV, then press **▶** repeatedly until the *Audio* menu opens.



2. Press **▲** or **▼** to select *Lip Sync*.
3. Press **◀** or **▶** to adjust *Lip Sync*.
4. Press **EXIT** to exit the OSD.

AVL

Auto Volume Leveling (AVL) reduces sudden volume changes during commercials and when changing channels.

1. Press **MENU** on the remote control or the side of your HDTV, then press **▶** repeatedly until the *Audio* menu opens.



2. Press **▲** or **▼** to select *AVL*.
3. Press **◀** or **▶** to select *On* or *Off*.
4. Press **EXIT** to exit the OSD.



Adjusting the TV settings

If you did not set up your HDTV for DTV / TV channels using the Initial Setup screens or if your setup has changed, you can do so from the TV menu.

Tuner Mode

1. Press **MENU** on the remote control or the side of your HDTV, then press **▶** repeatedly until the TV menu opens.



2. Press **▲** or **▼** to select *Tuner Mode*, then press **◀** or **▶** to choose *Cable* or *Antenna (Air)* depending upon which equipment you have connected to the DTV / TV Input.
3. Press **EXIT** to exit the OSD.

Auto Search

Your HDTV can scan for channels in your area and store the channel information in the channel list. If a channel does not have a signal, your HDTV skips that channel. When you press CH **▲** or CH **▼**, your HDTV changes to the next channel in the channel list.

1. Press **MENU** on the remote control or the side of your HDTV, then press **▶** repeatedly until the TV menu opens.



2. Press **▲** or **▼** to select *Auto Search*, then press **▶**. The *Auto Search* screen opens and begins searching for analog and digital channels.
3. When the channel search is complete, press **EXIT** to exit the OSD.



Skip Channel

After your HDTV has stored all of the available DTV channels in memory, you can delete channels from the channel list that you do not want to see. You can still tune to deleted channels using the channel buttons on the remote control.

1. Press **MENU** on the remote control or the side of your HDTV, then press **▶** repeatedly until the TV menu opens.



2. Press **▲** or **▼** to select *Skip Channel*, then press **▶**. The *Skip Channel* menu opens.



3. Press **▶** to select the channel to be skipped.
4. Press **EXIT** to exit the OSD.



MTS

Multichannel television sound (MTS) allows you to select Stereo, SAP, or Mono.

1. Press **MENU** on the remote control or the side of your HDTV, then press **▶** repeatedly until the TV menu opens.



2. Press **▲** or **▼** to select *MTS*, then press **◀** or **▶** to choose *Mono*, *Stereo*, or *SAP*.
3. Press **EXIT** to exit the OSD.

Time Zone

Setting the correct Time Zone for your area ensures that the correct program times are shown in the Electronic Program Guide.

1. Press **MENU** on the remote control or the side of your HDTV, then press **▶** repeatedly until the TV menu opens.



2. Press **▲** or **▼** to select *Time Zone*, then press **◀** or **▶** to select your time zone.
3. Press **EXIT** to exit the OSD.



Daylight Saving

Setting the daylight saving time for your area will ensure that the correct program times are shown in the Electronic Program Guide.

1. Press **MENU** on the remote control or the side of your HDTV, then press ► repeatedly until the TV menu opens.



2. Press ▲ or ▼ to select *Daylight Saving*, then press ◀ or ▶ to select *On* or *Off*.
3. Press **EXIT** to exit the OSD.



Adjusting the Setup settings

When viewing a DTV / TV or an HDMI, Component, AV, or PC source, the following setup adjustment OSD screens are available when you press **MENU** on the remote control.

NOTE: When a computer is the source, the CC option is not available.

Language

Select the language displayed in the OSD menus.

1. Press **MENU** on the remote control or the side of your HDTV, then press **►** until the *Setup* menu opens.



2. Press **▲** or **▼** to select *Language*, then press **◀** or **▶** to select *English*, *Espanol*, or *Francais*.
3. Press **EXIT** to exit the OSD.

Source

Select the input source.

1. Press **MENU** on the remote control or the side of your HDTV, then press **►** until the *Setup* menu opens.



2. Press **▲** or **▼** to select *Source*, then press **◀** or **▶** to select *TV*, *Comp*, *AV1*, *AV2*, *HDMI1*, *HDMI1*, or *RGB*.
3. Press **EXIT** to exit the OSD.



Sleep Timer

Your HDTV can be set to turn off automatically after 30, 60, 90, or 120 minutes.

4. Press **MENU** on the remote control or the side of your HDTV, then press **▶** until the *Setup* menu opens.



5. Press **▲** or **▼** to select *Sleep Timer*, then press **◀** or **▶** to select 30, 60, 90, or 120 minutes.
6. Press **EXIT** to exit the OSD.

Wide

The *Wide* option lets you determine how the image appears on the screen.

1. Press **MENU** on the remote control or the side of your HDTV, then press **▶** until the *Setup* menu opens.



2. Press **▲** or **▼** to select *Wide*, then press **◀** or **▶** to select *Normal*, *Wide*, or *Panoramic*. The screen image changes as you select each option.
3. Press **EXIT** to exit the OSD.



CC (Closed Caption)

Select CC to adjust Closed Caption settings.

1. Press **MENU** on the remote control or the side of your HDTV, then press **▶** until the *Setup* menu opens.



2. Press **▲** or **▼** to select *CC*, then press **▶**. The *CC* menu opens.
3. Press **▶** to choose *Off*, *CC1*, *CC2*, *CC3*, or *CC4*.
4. Press **EXIT** to exit the OSD.

Digital CC Style

Set the look of your Close Captions. *Broadcast* displays the style chosen by the broadcast channel for transmission. *Custom* allow you to customize the appearance.

1. Press **MENU** on the remote control or the side of your HDTV, then press **▶** until the *Setup* menu opens.



2. Press **▼** to select *Digital CC Style*, then press **◀** or **▶** to choose *Broadcaster* or *Custom*.
3. If you choose *Custom*, the *Digital CC Style* menu opens. Press **▲** or **▼** and **◀** or **▶** to change the following parameters:
 - Caption Style
 - Font Size
 - Font Color
 - Font Opacity (transparency of the letters)
 - Background Color (color of the background area where closed captions are displayed)
 - Background Opacity (the transparency of the background)
 - Window Color (color of the window surrounding the closed captions subtitles)
 - Window Opacity (the transparency of the box surrounding the closed captions subtitles)
4. Press **EXIT** to exit the OSD.



H/V Position

Adjust the Horizontal and Vertical positions of the screen.

1. Press **MENU** on the remote control or the side of your HDTV, then press **►** until the *Setup* menu opens.



2. Press **▲** or **▼** to select *H/V Position*, then press **►**. Press **▲** or **▼** to select *H/V Position*, then press **►**. The *H/V Position* menu opens.



4.5.7.1 H. Position (Horizontal Position)

1. Press **▼** to select *H.Position*.
2. Press **◀** or **▶** to adjust the horizontal position.
3. Press **EXIT** to exit the OSD.

4.5.7.2 V. Position (Vertical Position)

1. Press **▼** to select *V.Position*.
2. Press **◀** or **▶** to adjust the vertical position.
3. Press **EXIT** to exit the OSD.

4.5.7.3 H-SIZE (Horizontal Size)

1. Press **▼** to select *H-Size*.
2. Press **◀** or **▶** to adjust the horizontal size.
3. Press **EXIT** to exit the OSD.

4.5.7.4 V-SIZE (Vertical Size)

1. Press **▼** to select *V-Size*.
2. Press **◀** or **▶** to adjust the vertical size.
3. Press **EXIT** to exit the OSD.



Reset All Setting

1. Press **MENU** on the remote control or the side of your HDTV, then press **▶** until the *Setup* menu opens.



2. Press **▲** or **▼** to select *Reset All Setting*, then press **▶**. The settings are reset to factory defaults.
3. Press **EXIT** to exit the OSD.

NOTE: *This does NOT reset the Parental Control Password.*



Adjusting the Parental Control settings

When viewing a DTV / TV or a component, or AV source, the following parental control OSD screens are available within the *Parental Control* OSD menu. Parental Control options are not available when viewing an HDMI source.

You can restrict certain channel and program viewing by turning on parental controls. Selected programs, movies and channels can then be made available only after an authorized password has been entered.

Channel Block

1. Press **MENU** on the remote control or the side of your HDTV, then press **▶** repeatedly until the *Parental Control* menu opens.

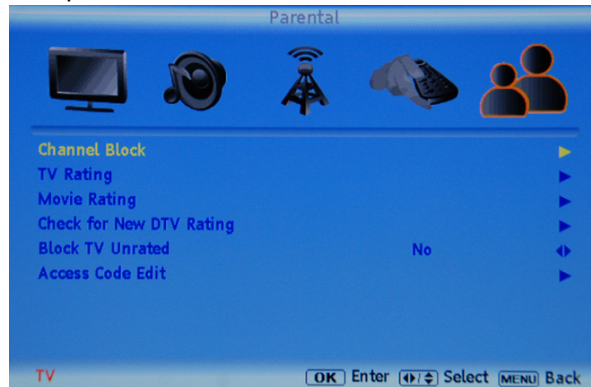

2. Press **▲** or **▼** to select *Channel Block*, then press **▶**. The *Channel Block* menu opens.



3. Press **▲** or **▼** to choose the channel you want to block.
4. Press **OK** to block the highlighted channel.
5. Press **EXIT** to exit the OSD.



TV Rating

1. Press **MENU** on the remote control or the side of your HDTV, then press **▶** repeatedly until the *Parental Control* menu opens.



2. Press **▲** or **▼** to select *TV Rating*, then press **▶**. The *TV Rating* menu opens.



3. Press **▲** or **▼** and **◀** or **▶** to navigate through the TV rating options. See the table below for TV Rating definitions.
4. Press **OK** to block (locked) or unblock (unlocked).
5. Press **EXIT** to exit the OSD.

TV Rating Definitions:	TV Rating Content Definitions
Y – All children	A – All subratings
Y7 – Older children	D – Sexual dialog
G – General audience	L – Adult language
PG – Guidance suggested	S – Sexual situations
14 – Strongly cautioned	V - Violence
MA – Mature audience	FV – Fantasy violence



Movie Rating

1. Press **MENU** on the remote control or the side of your HDTV, then press **▶** repeatedly until the *Parental Control* menu opens.



2. Press **▲** or **▼** to select *Movie Rating*, then press **▶**. The *Movie Rating* menu opens.



3. Press **▲** or **▼** and **◀** or **▶** to navigate through the movie rating options. See the table below for movie rating definitions.
4. Press **OK** to block (locked) or unblock (unlocked).
5. Press **EXIT** to exit the OSD.

Movie Rating Definitions:	
G	– General audience
PG	– Parental guidance suggested
PG-13	– Recommended for children 13 years of age or older
R	– Mature audience
NC-17	– No one under 17 years of age
X	– No one under 17 years of age



Check for New DTV Rating

This option is designed to update the TV or Movie ratings table for programs being viewed in your local or regional area. It lets the parental guidance control feature in your HDTV to have the most current parental control database for a digital signal. If there is a red x in front of *DTV Rating*, no update is available or the option is not activated in your area.

To update the table:

1. Press **▲** or **▼** to select *Update DTV Rating*, then press **▶**. The *Update DTV Rating* screen opens.

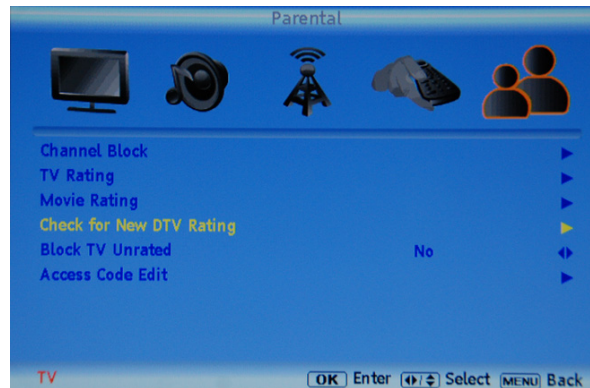

2. Press **OK** to begin the update.
3. Press **EXIT** to exit the OSD.

Blocked Unrated TV

The *Blocked Unrated TV* option lets you block programming that does not have a rating.

1. Press **MENU** on the remote control or the side of your HDTV, then press **▶** repeatedly until the *Parental Control* menu opens.



2. Press **▲** or **▼** to select *Block Unrated TV*.
3. Press **▶** to select Yes or No.
4. Press **EXIT** to exit the OSD.



Access Code Edit

The *Access Code Edit* option lets you change the password used to access the *Parental* menu.

1. Press **MENU** on the remote control or the side of your HDTV, then press **▶** repeatedly until the *Parental Control* menu opens.



2. Press **▲** or **▼** to select *Access Code Edit*, then press **▶**. The *Access Edit Code* menu opens.

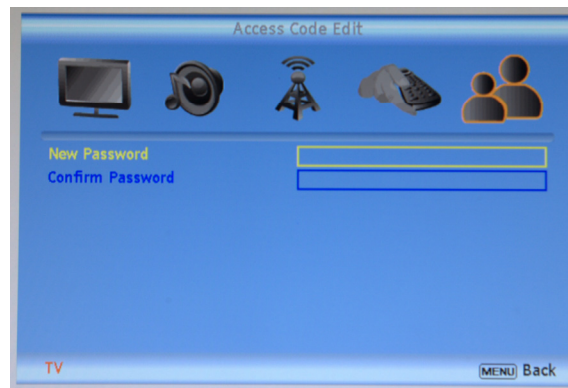

3. Enter the new 4-digit password using the number buttons on the remote.
4. Enter the password a second time to confirm you entered it correctly.
5. Press **EXIT** to exit the OSD.

NOTE: *Make sure you write down and store the new password in a secure place.*



Understanding Viewing Modes

Your HDTV features the following viewing modes. You can switch viewing modes by pressing **WIDE** on the remote control.

Normal Mode

The original 4:3 aspect ratio (1.33:1 source) is preserved, so black bars are added to the left and right of the display image. Standard TV broadcasts are displayed with a 4:3 Aspect Ratio. Movies in 4:3 Aspect Ratio may be referred to as pan-and-scan or full-frame. These movies were originally filmed in 16:9 (widescreen), and then modified to fit a traditional TV screen (4:3).

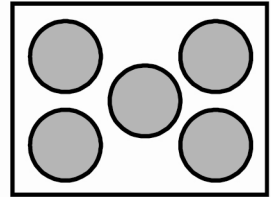

Wide Mode

When watching a standard broadcast or full-frame movie in this mode, the display image is stretched proportionately to fill the TV screen. When watching a widescreen (1.78:1 source) program or movie, the display image fills the TV screen. If you are watching a widescreen (1.85:1 or 2.35:1 source) program or movie, there will still be black bars at the top and bottom.

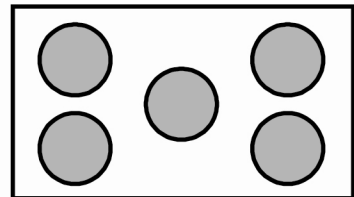

Panoramic Mode

When watching a standard broadcast or full-frame movie in this mode, the 4:3 Aspect Ratio (1.33:1 source) display image is stretched horizontally on the left and right sides to fill the TV screen. The center of the image is not stretched.

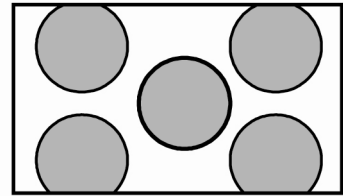

Maintaining and Troubleshooting

Maintenance

Important

1. Make sure that the power cord is removed from the socket before cleaning your HDTV.
2. Do not use volatile solvents (such as toluene, rosin, and alcohol) to clean your HDTV. Such chemicals may damage the housing, screen glass, and remote control, and cause paint to peel.

Cleaning the Housing and Remote Control

1. Use a soft cloth for cleaning.
2. If the housing or remote control is especially dirty, use a soft cloth moistened with diluted neutral cleaner to clean the display. Squeeze water out of the cloth before cleaning to prevent water from penetrating into the housing. Wipe the display with a dry cloth after cleaning.

Cleaning the Screen

1. Use a soft cotton cloth to gently clean the screen.
2. The screen glass is very fragile. Do not scrape it with any sharp object. Do not press or tap the screen or it may crack. When the screen is seriously contaminated, use a soft cloth moistened with a diluted neutral cleaner to clean the display. Squeeze water out of the cloth before cleaning to prevent water from penetrating into the housing. Wipe the display with a dry cloth after cleaning.



Troubleshooting

If your HDTV fails or the performance changes dramatically, follow the steps in the troubleshooting table below. Remember to check peripherals as well, to pinpoint the source of the failure. If your HDTV still fails to perform as expected, contact the VIZIO for assistance by calling 1-877-MYVIZIO (877-698-4946) or e-mail us at techsupport@VIZIO.com.

Problem	Solution
"No Signal" error message	<ul style="list-style-type: none"> Press INPUT to select a different source.
No power	<ul style="list-style-type: none"> Make sure the power is ON. The VIZIO logo will be white. Make sure the power cord is securely connected to the back of your HDTV and the power outlet. Connect another electrical device into the power outlet to verify that the outlet is supplying the proper voltage.
No sound	<ul style="list-style-type: none"> Check your audio connections on the back of your HDTV and on the back of the component. Make sure the volume is not turned down. Make sure that the sound is not muted. Make sure that headphones are not connected. Check your audio settings in the OSD. See "Adjusting the Audio Settings." Your HDTV audio may be set to SAP, minimum, or speakers off.
The screen is black	<ul style="list-style-type: none"> Check the connections on the back of your HDTV and on the back of the component. Make sure the power cord is securely connected to the back of your HDTV and a grounded power outlet. Make sure the power is ON. The VIZIO logo will be white. Make sure that the selected input source (i.e. DVD player) is working properly. If your HDTV is connected to your computer in RGB or HDMI mode, press any key on your keyboard to "wake" your computer.
Power is ON but there is no screen image.	<ul style="list-style-type: none"> Check the connections on the back of your HDTV and on the back of the component. Adjust brightness and contrast. Press INPUT to select a different source.
Colors are wrong or abnormal	<ul style="list-style-type: none"> If any colors (red, green, or blue) are missing, check the video cable to make sure it is securely connected.
Control buttons do not work	<ul style="list-style-type: none"> Press only one button at a time.
Remote Control does not work	<ul style="list-style-type: none"> Make sure batteries are inserted correctly. Replace expired batteries. Press the correct source on the remote control (i.e. TV to control the TV source).
Image quality issues	<ul style="list-style-type: none"> Standard, analog TV will always be noticeably inferior to HD because your digital flat panel TV has video that is many times better than older TVs. You will see interference and deficiencies you did not know you had. For best image quality, view HD wide screen programs where possible. If HD content is not available view "Standard Definition" from a digital source.
Picture is distorted picture	<ul style="list-style-type: none"> You may be getting interference from electrical appliances, cars, motorcycles, or fluorescent lights. If you have not mounted it on the wall, try moving your HDTV to another location to see if this is the cause of the problem. You may be getting interference from a device on the same electrical circuit. Try plugging your HDTV into another power outlet.
There is an unusual sound	<ul style="list-style-type: none"> You may be getting interference from electrical appliances, cars, motorcycles, or fluorescent lights. If you have not mounted it on the wall, try moving your HDTV to another location to see if this is the cause of the problem.



Problem	Solution
The picture has abnormal patterns	<ul style="list-style-type: none"> • Check the connections on the back of your HDTV and on the back of the component. • Make sure that the video input source is within the range of your HDTV. Compare the video input source's specifications with your HDTV specifications.
The display image does not cover the entire screen	<ul style="list-style-type: none"> • If you are in RGB mode (PC), make sure that H-Size and V.Position in the OSD are set correctly. See "Adjusting the Setup Settings" • Press WIDE on the remote control to scroll through the screen modes.
There is a picture but no sound	<ul style="list-style-type: none"> • Make sure that the volume is not turned down. • Make sure that the sound is not muted. • Check the connections on the back of your HDTV and on the back of the component.
Your HDTV has pixels that are always dark or colored	<ul style="list-style-type: none"> • Your HDTV is manufactured using an extremely high level of precision technology. However, some pixels of your TV may not display. Pixel defects within industry specifications are inherent to this type of product and do not constitute a defective product.
There is "noise" or "trash" on the screen	<ul style="list-style-type: none"> • When your HDTVs' digital capabilities exceed a digital broadcast signal, the signal is up-converted (increased) to match your HDTVs display capabilities. Up-converting can cause noise or trash.
The volume changes when you switch inputs	<ul style="list-style-type: none"> • Your HDTV remembers the volume level from the last time you adjusted it. If the sound level is higher or lower from another input, then the volume will change.

Telephone & Technical Support

Products are often returned due to a technical problem rather than a defective product which may result in unnecessary shipping charges billed to you. Our trained support personnel can often resolve the problem over the phone. For more information on warranty service or repair, after the warranty period, contact our Support Department at the number below.

Customer support and quality service are integral parts of VIZIO's commitment to service excellence. For technical assistance, contact our VIZIO Technical Support Department via e-mail or phone.

E-mail: techsupport@vizio.com

(877) 698-4946

Fax: (949) 585-9563

Hours: Monday - Friday: 6am to 9pm

Saturday - Sunday 8 am to 4pm

Address:

39 Tesla, Irvine, CA 92618

Telephone: (949) 428-2525 Fax: 949-585-9514

Web: www.VIZIO.com

Have your VIZIO model number, serial number, and date of purchase available before you call.



Regulations and Specifications

Compliance

Caution: Always use a power cord that is properly grounded. Use the AC cords listed below for each area.

Country	Power Cord
USA	UL
Canada	CSA
Germany	VDE
UK	BASE/BS
Japan	Electric Appliance Control Act

FCC Class B Radio Interference Statement

NOTE: This equipment has been tested and found to comply with the limits for a Class B digital device, pursuant to Part 15 of the FCC Rules. These limits are designed to provide reasonable protection against harmful interference in a residential installation. This equipment generates, uses and can radiate radio frequency energy, and if not installed and used in accordance with the instructions, may cause harmful interference to radio communications. However, there is no guarantee that interference will not occur in a particular installation. If this equipment does cause harmful interference to radio or television reception, which can be determined by turning the equipment off and on, the user is encouraged to try to correct the interference by one or more of the following measures:

1. Reorient or relocate the receiving antenna.
2. Increase the separation between the equipment and receiver.
3. Connect the equipment into an outlet on a circuit different from that to which the receiver is connected.
4. Consult the dealer or an experienced radio/TV technician for help.

Notice:

1. The changes or modifications not expressly approved by the party responsible for compliance could void the user's authority to operate the equipment.
2. Shielded interface cables and AC power cord, if any, must be used in order to comply with the emission limits.
3. The manufacturer is not responsible for any radio or TV interference caused by unauthorized modification to this equipment. It is the responsibilities of the user to correct such interference.



Specifications

Specifications	
Model #	VA26L HDTV10T
VIZIO Series	VA SERIES
Size of Display (diagonal)	26 Inch
Flat Panel Technology Type	Liquid Crystal Technology
Resolution	1366 x 768 pixels
Number of Pixels	1,049,088
Pixel (Dot) Pitch	0.4215mm x 0.4215mm
Optimized Display Mode	720p(HDTV)
TV Signal Compatibility	480i (SDTV), 480P (EDTV), 720P (HDTV), 1080i (HDTV)
Response Time (Typical) Milliseconds	8 ms
Brightness (cd/m²)	500
Contrast	800:1 (typical)
Contrast DCR	2400:1
Color Performance	16.2 Million
Viewing Angle	160/150 degrees (horizontal/vertical)
REAR Inputs	<ul style="list-style-type: none"> • 1xRF (F connector for internal NTSC/ATSC/QAM tuner) • 2x HDMI -- 1xHDMI with HDCP (with Stereo Analog Audio) • 1x Component Video plus Stereo Audio • 1x Composite Video / 1x Stereo Audio • 1x Analog RGB plus Stereo Audio
Side Game Port Inputs	<ul style="list-style-type: none"> • 1xS-Video • 1xComposite • 1x Headphone • 1xStereo Audio (shared)
Outputs	1x Headphone - Side
Computer Input (VGA or DVI)	YES
Color Equalizer	YES
Action Sensor Technology	YES
Reduced Pixel Noise Circuit	YES
Enhanced Contrast Technology	YES
Balanced Color	YES
Features	<ul style="list-style-type: none"> • AV at SIDE I/O for Game access • CC • V-Chip • 3D Comb Filter • Motion Adaptive De-Interlace • 3:2 or 2:2 Reverse Pull-down • 4:3 & 16:9 conversion • ATSC with 8VSB & QAM demodulation with MPEG-2 decoding • NTSC Video decoding via RF (Antenna, Cable or Satellite) or Video (CVBS, S-Video or Component) • Progressive Scan Video via Component YPbPr, VGA or HDMI • HDTV via HDMI or Component YPbPr • Computer 640x480, 800x600, 1024x768, 1366 x 768 via VGA or HDMI • Virtual Sound enhancement • Color Temperature of 6500K, 5400K and 9300K • Independent Red, Green and Blue adjustment for user fine tuning of color temperature
Built In Audio (Included Audio Feature)	2 x 5W
Panel Life to 1/2 Brightness (hours)	60,000
Voltage Range	100-240 Vac at 50/60 Hz.
Power Consumption	130W (max), <1W Standby
Remote Control	VIZIO TV Remote Control
Cleaning Cloth	YES
Warranty	1 Year warranty
Dimensions	25.7"W x 19.1"H x 8.7"D with stand 25.7"W x 17.3"H x 3.7"D without stand
Weight	19.6 lbs with stand 17.4 lbs without stand
Certifications	CSA/ CSA-US, FCC Class B



Preset Computer Resolutions

If connecting to a computer through the RGB PC input, set the TV timing mode to VESA 1366 x 768 at 60Hz for better picture quality. Refer to your computer or graphic card's user guide for information on how to set this timing mode. See the table below for the factory preset resolutions. Also see the chart below: "Resolution through VGA Input" for the best resolution that can be obtained through the RGB PC input when the video card supports 1366 x 768.

Resolution	Refresh (Hz)	H.Freq (kHz)	V.Freq (Hz)	H.Sync	V.Sync	Pixel Freq (MHz)
640x480	60	31.5	59.94	N	N	25.175
640x480	75	37.5	75.00	N	N	31.500
720x400	70	31.46	70.08	N	P	28.320
800x600	60	37.9	60.317	P	P	40.000
800x600	75	46.9	75	P	P	49.500
1024x768	60	48.4	60.01	N	N	65.000
1024x768	75	60.0	75.03	P	P	78.750
* 1360x768	60	47.7	59.79	P	P	85.500

NOTES: N = Negative, P = Positive, * = Native Resolution with Reduced Blanking, see below for more details, ** = DOS Mode



VIZIO LIMITED PRODUCT WARRANTY

VIZIO provides a "ONE-YEAR LIMITED WARRANTY" against manufacturing defects in materials and workmanship to the original purchaser of a new VIZIO display purchased from an authorized VIZIO U.S. reseller and used in the fifty (50) United States or Puerto Rico.

VIZIO's Responsibility

VIZIO displays purchased new from an authorized VIZIO U.S. reseller and that are used in the fifty (50) United States or Puerto Rico are warranted to be free from manufacturing defects in materials and workmanship for one (1) year from the date of the original retail purchase. If the display fails to conform to this limited warranty, VIZIO will, at its option and sole discretion, repair or replace the display.

Labor

During the one-year limited warranty period, VIZIO will provide, when needed, service labor to repair a manufacturing defect. Repairs required on displays which are thirty (30) inches and larger generally will be made "on-site" where the display is installed. The determination for performing the on-site repair is dependent upon the manufacturing defect and is at VIZIO's option and sole discretion. Repairs required on displays which are less than thirty (30) inches generally will be performed at a VIZIO service center.

Parts

Repairs may be made with new or recertified parts, or the entire unit may be replaced with a new or recertified unit, at VIZIO's option and sole discretion. Replacement parts or replacement units provided under this limited warranty are warranted for the remaining portion of the original warranty period, or for ninety (90) days from warranty service or replacement, whichever is later.

How to Obtain Warranty Service

To obtain warranty service, contact VIZIO Technical Support via email at TechSupport@VIZIO.com, via phone at 877-MYVIZIO (877-698-4946), or via postal mail at VIZIO Technical Support, 39 Tesla, Irvine, CA 92618. You must provide the model, serial number, and date of purchase. VIZIO Technical Support is available from 6:00AM to 9:00PM Pacific Time, Monday through Friday, and 10:00AM to 2:00PM Pacific Time, Saturday and Sunday. Please note that holiday hours may vary. For up to date information, please visit www.VIZIO.com.

VIZIO reserves the right to assess all warranty claims and to determine if defects or damages are covered by this limited warranty. In case of a claim that is not covered by this warranty, you will be contacted to determine whether VIZIO should repair the damage for a fee or whether the product should be returned to you as received by the service technician or service center.

Parts and service labor that are VIZIO's responsibility under this limited warranty will be provided without charge. All other service is at the customer's expense. VIZIO reserves the right to charge the customer for any service call for anything not covered by this limited warranty. Before you ask for warranty service, please review your User Manual. You may avoid a service call and a service charge.

Please refer to the reverse side of this page for additional information regarding how to obtain warranty service.

PLEASE DO NOT RETURN YOUR UNIT TO VIZIO WITHOUT PRIOR AUTHORIZATION.



Not Covered

This limited warranty does not cover the following: cosmetic defects; damage, malfunctions or failures resulting from shipping or transit, improper or faulty installation, abuse, operation contrary to furnished instructions, operation on incorrect power supplies, products not supplied by VIZIO, modification, alteration, improper servicing or tampering; damage from fire, water, lightning, power surges, abnormal environmental conditions or other acts of nature; normal wear and tear; unsatisfactory visual or audio performance not caused by a manufacturing defect; or displays with a missing or unreadable serial number. Operation of the display for commercial purposes or in applications or uses for which the display is not intended is not covered by this limited warranty. "Image Sticking", caused by static images on the screen for extended periods and or excessive brightness and contrast levels, is not covered by this limited warranty. Installation, removal, transportation and reinstallation of a display, and routine maintenance and cleaning, are not covered by this limited warranty.

THERE ARE NO EXPRESS WARRANTIES OTHER THAN THOSE LISTED OR DESCRIBED ABOVE. ANY IMPLIED WARRANTIES, INCLUDING ANY IMPLIED WARRANTY OF MERCHANTABILITY AND FITNESS FOR A PARTICULAR PURPOSE, SHALL BE LIMITED IN DURATION TO THE PERIOD OF TIME SET FORTH ABOVE. VIZIO'S TOTAL LIABILITY FOR ANY AND ALL LOSSES AND DAMAGES RESULTING FROM ANY CAUSE WHATSOEVER, INCLUDING VIZIO'S NEGLIGENCE, ALLEGED DAMAGE, OR DEFECTIVE GOODS, WHETHER SUCH DEFECTS ARE DISCOVERABLE OR LATENT, SHALL IN NO EVENT EXCEED THE PURCHASE PRICE OF THE DISPLAY. VIZIO SHALL NOT BE RESPONSIBLE FOR LOSS OF USE, COMMERCIAL LOSS, LOST REVENUE OR LOST PROFITS, OR OTHER INCIDENTAL OR CONSEQUENTIAL DAMAGES. SOME STATES DO NOT ALLOW LIMITATIONS ON HOW LONG AN IMPLIED WARRANTY LASTS OR THE EXCLUSION OR LIMITATION OF INCIDENTAL OR CONSEQUENTIAL DAMAGES, SO THE ABOVE LIMITATIONS OR EXCLUSIONS MAY NOT APPLY TO YOU.

This warranty gives you specific legal rights, and you may also have other rights, which vary from state to state. This is the only warranty applicable; no one is authorized to extend or modify it or to grant any other warranty on VIZIO's behalf.

Owner's Responsibility

To ensure warranty service, keep the dated bill or sales receipt as evidence of the purchase date and location. This limited warranty applies only to original purchaser and is non-transferable.

Note: Warranty service conditions are subject to change. For the latest Warranty Terms and Conditions and additional information regarding VIZIO's Limited Product Warranty, please see complete details online at www.VIZIO.com.

VIZIO RETURN POLICY

VIZIO's return policy allows for products purchased directly from VIZIO to be returned by the original purchaser during the initial thirty (30) day period following the date of purchase. A VIZIO return authorization number must first be obtained as provided below. The refund will be the purchase price actually paid by the purchaser less a ten percent (10%) restocking fee per each item returned. Shipping and handling are not refundable.

The return authorization number must first be obtained from VIZIO's Customer Service by emailing CustomerSupport@VIZIO.com or by calling 949-428-2525, 6:00AM to 9:00PM Pacific Time, Monday through Friday, and 10:00AM to 2:00PM Pacific Time, Saturday and Sunday. Please note that holiday hours may vary. For up to date information, please visit www.VIZIO.com.

Products must be returned to the address specified by VIZIO Customer Service and must be shipped in the original packaging, with freight prepaid to VIZIO, and must be received in new and unused condition. The return authorization number must be included in the packaging. VIZIO reserves the right to assess fees for any damaged or missing parts in addition to the ten percent (10%) restocking fee.



Return authorization numbers are valid for only fifteen (15) days from issuance. The customer is responsible for and must prepay all shipping charges and shall assume all risk of loss or damage to the product while in transit to VIZIO. If the product is returned to VIZIO (i) without a VIZIO return authorization number, and/or (ii) beyond the fifteen (15) day period, and/or (iii) without proper packaging, VIZIO retains the right to refuse delivery of such return or may return the unit to the customer at the customer's expense and with no refund issued. This return policy does not apply to defective products. Please read VIZIO's Limited Product Warranty for warranty terms and conditions.

On-Site Warranty Repair Procedure

On-Site Warranty Repair generally is performed on repairable displays which are 30 inches and larger.

If VIZIO Technical Support determines that a problem with a display unit may be within the terms and conditions of the VIZIO Limited Product Warranty and that an on-site repair may be performed, the customer will be provided with an on-site repair authorization number and on-site repair instructions. The determination for performing the on-site repair may be dependent upon the manufacturing defect and is at VIZIO's option and sole discretion. Proof of purchase is required to confirm the product is within the one-year limited warranty period and meets the terms and conditions of the VIZIO Limited Product Warranty.

On-site repair service is requested through VIZIO's third-party service provider. After VIZIO provides the customer with the on-site repair (OSR) authorization number, the third-party service provider will contact the customer and will schedule the repair at the customer's location. The total approximate time for the repair process, which includes the repair diagnosis, dispatching the technician, shipping the replacement part(s), and arranging the appointment with the customer, is completed within approximately 3 to 5 business days, pending availability of these factors.

If it is determined the product can not be repaired on-site, the customer will be required to ship the unit to VIZIO's service center, per the below warranty replacement procedure.

VIZIO is not responsible for the de-installation or re-installation of the product. However, some standard installation may be performed during the on-site repair, at VIZIO's option and sole discretion. Please read VIZIO's Limited Product Warranty for warranty terms and conditions.

Warranty Replacement Procedure

Warranty Replacement generally is performed on displays which are determined to be economically unrepairable.

If VIZIO Technical Support determines that a problem with a display unit may be within the terms and conditions of the VIZIO Limited Product Warranty and that a repair is not economically possible, based on certain manufacturing defects in materials and/or workmanship, and/or at VIZIO's option and sole discretion, the customer will be provided with a return authorization number and replacement instructions. Proof of purchase is required to confirm the product is within the one-year limited warranty period and meets the terms and conditions of the VIZIO Limited Product Warranty.

For displays forty-two inches (42") and larger, VIZIO will generally cover the transportation charges to perform an on-site swap of the original unit with the replacement unit. For displays under forty-two inches (42"), the customer is responsible for the transportation charges to VIZIO's service center. VIZIO will be responsible for the return transportation charges from the service center to the customer. Please read VIZIO's Limited Product Warranty for warranty terms and conditions.



Mail-In Warranty Repair Procedure

Mail-In Warranty Repair generally is performed on displays which are smaller than 30 inches.

If VIZIO Technical Support determines that a problem with a display unit may be within the terms and conditions of the VIZIO Limited Product Warranty and that a mail-in repair may be performed, the customer will be provided with a return authorization number and mail-in repair instructions. Proof of purchase is required to confirm the product is within the one-year limited warranty period and meets the terms and conditions of the VIZIO Limited Product Warranty.

The customer will be provided with instructions for packing and shipping the unit to the VIZIO service center. The original carton box and packing material, or an equivalent as designated by VIZIO, must be utilized. The cost of shipping to VIZIO's service center is at the customer's expense. After the product is repaired and tested, the VIZIO service center will ship the unit back to the customer at VIZIO's expense. VIZIO is not responsible for the de-installation or re-installation of the product. Please read VIZIO's Limited Product Warranty for warranty terms and conditions.

PLEASE DO NOT RETURN YOUR UNIT TO VIZIO WITHOUT PRIOR AUTHORIZATION.



Index

A

AC IN jack, 11
access code
 changing, 56
accessories, 8
adaptive luma, 38
adjustments
 selecting the screen size, 13
advanced video settings
 black level extender, 37
antenna
 connecting through VCR, 19
 setting as TV signal source, 43
antenna grounding, 5
antenna jack, 11
aspect ratio
 descriptions, 57
 selecting, 48
audio settings
 adjusting, 39
 AVL (auto volume), 42
 balance, 40
 bass, 39
 lip sync, 42
 speakers, 41
 surround mode, 41
 treble, 40
 volume, 39
AV In jack, 11
AV2, 10
AVL (auto volume)
 turning off and on, 42

B

backlight
 adjusting, 33
balance
 adjusting, 40
bass
 adjusting, 39
black level extender, 37
blocking channels, 52
brightness
 adjusting, 33

C

cable
 setting as TV signal source, 43
cable TV
 component connection, 17

composite connection, 17, 18, 22
 connecting, 15
 connecting through VCR, 19
 DVI connection, 16
 HDMI connection, 15

CC (Closed Caption)

selecting, 49

channel block

selecting, 52

channel buttons, 9

channels

deleting, 44
 searching for, 43

cleaning

remote control, 58
 screen, 58

closed caption

digital CC style, 49

coaxial connection

cable TV, 18
 satellite box, 18

color

adjusting, 34

color temperature

adjusting, 36

component connection

cable TV, 17
 DVD player, 21
 satellite TV, 17

component jacks, 11

composite connection

cable TV, 17, 18, 22
 DVD player, 22
 satellite box, 17, 18, 22

computer

connecting, 23
 resolutions, 63

connecting

antenna through VCR, 19
 cable TV, 15
 computer, 23
 DTV, 19
 DVD player, 20
 satellite box, 15
 VCR, 23
 video camera, 23

contrast

adjusting, 34

CTI, 38



D

daylight saving
selecting, 46, 47

Digital CC Style
setting, 49

DNR, 37

DTV

jack, 11

DVD player

component connection, 21
composite connection, 22
connecting, 20
DVI connection, 21
HDMI connection, 20

DVI

cable TV connection, 16
DVD player connection, 21
satellite box connection, 16

dynamic noise reduction, 37

F

FCC Bulletin for New TV Owners, 5

FCC statement, 61

fine-tuning the picture, 29

flesh tone, 38

front bezel, 9

power indicator, 9
remote control sensor, 9

H

H/V Position

setting, 50

HDMI

cable connection, 15
DVD player connection, 20
satellite connection, 15

HDMI 1 jack, 11

HDMI 2 jack, 11

headphone jack, 10

I

information banner, 30

installation services, 8

language

selecting OSD, 47

lip sync

turning off and on, 42

M

maintaining, 58

MENU button, 9

movie ratings

blocking, 54

MTS

Stereo, SAP, Mono, 45

N

Normal aspect ratio, 57

O

On-Screen Display, 31

selecting language, 47

OSD, 31

selecting language, 47

P

package contents, 8

Panoramic aspect ratio, 57

parental control

access code edit, 56
block unrated TV, 55
channel block, 52
check for new DTV rating, 55
movie rating, 54
options, 52
TV rating, 53

password

changing, 56

picture mode

adjusting, 32

picture settings, 32

advanced video, 37
backlight, 33
brightness, 33
color, 34
color temperature, 36
contrast, 34
picture mode, 32
sharpness, 35
tint, 35

power button, 9

power connector, 11

power cord, 61

power indicator, 9

program guide, 30

R

rear jacks, 11

AC IN, 11
antenna, 11
AV In, 11
component, 11
HDMI 1, 11
HDMI 2, 11
power connector, 11



RGB PC, 11
remote control
 buttons, 12
 installing batteries, 25
 programming cable remote control, 31
 programming satellite TV remote control, 31
 range, 13
 safety, 13
 sensor, 9
resetting
 all settings, 51
resolution
 preset computer, 63
return policy, 65
RGB PC jacks, 11

S

safety instructions, 3
SAP
 selecting, 45
satellite box
 component connection, 17
 composite connection, 17, 18, 22
 connecting, 15
 DVI connection, 16
 HDMI connection, 15
setting up, 14
 first time usage, 25
 selecting video connection, 14
setup menu
 closed caption, 49
 digital CC style, 49
 H/V position, 50
 language, 47
 options, 47
 reset all setting, 51
 sleep timer, 48
 source, 47
 wide, 48
sharpness
 adjusting, 35
side panel controls, 9, 10
 AV2, 10
 channel buttons, 9
 headphone jack, 10
 MENU button, 9
 power button, 9
 S-Video, 10
 volume buttons, 9
sleep timer
 setting, 48
source
 selecting, 47
speakers
 turning off and on, 41

specifications, 62
support

technical, 60
 telephone, 60

surround mode

turning off and on, 41

S-Video jack, 10

T

technical support, 60

telephone support, 60

time zone

selecting, 45

tint

adjusting, 35

treble

adjusting, 40

troubleshooting, 58, 59

tuner mode

selecting, 43

TV

settings

adjusting, 43

TV ratings

blocking, 53

TV signal source

selecting, 43

TV tuner settings

adjusting, 43

auto search, 43

daylight saving, 46

deleting channels, 44

MTS, 45

searching for channels, 43

skipping channels, 44

time zone, 45

tuner mode, 43

U

unrated TV

blocking, 55

update rating, 55

V

VCR

connecting, 23

video

adjusting, 37

video camera

connection, 23

video connection types, 14

video input

selecting, 28

video settings



- adaptive luma, 37
- adjusting, 37
- CTI, 37
- DNR, 37
- flesh tone, 37
- white peak limiter, 37
- viewing modes**
 - descriptions, 57
- volume**
 - adjusting, 39
- volume buttons, 9**

W

- wall mounting, 24**
- warranty services, 8**
- warranty, 64**
- white peak limiter, 37**
- Wide aspect ratio, 57**

